

M L King Jr Elementary School
CDS Code [6072235]

Phone: (510) 874-3381
Fax: (510) 874-3388

960 10th Street
Oakland, CA 94607

Legislative File ID No.: 15-0190
Introduction Date: 6/10/15
Enactment No.: 15-0816
Enactment Date: 6/10/15



School Year: 2015-2016

Comprehensive School Safety Plan

(Education Code Section 32280-32288)

ROMA GROVES
Principal

Jeff Godown, Chief of Police
Marcus Silvi, State and Federal Compliance
Jenny Wong, Emergency Preparedness Manager

Introduction

Each school district and county office of education is responsible for the overall development of all school safety plans for its schools operating kindergarten or any of grades 1 to 12, inclusive. The ***OUSD Comprehensive District Safety and Climate Plan*** brings together all of the elements of school safety to help meet our goal of providing a safe environment, both physical and social/emotional, that is conducive to learning. The district safety plan is used as a framework to assist site administrators with the development of their ***School Safety Plan***. As a framework, we encourage site Administrators to enhance and expand their site safety plans that is specific to their site's safety needs.

Index

SECTION 1: School Safety / Climate Team

- 1.1 School Safety / Climate Team
- 1.2 Emergency Telephone Number Directory

SECTION 2: School Safety Plan Goals

- 2.1 School Safety Plan Goals

SECTION 3: District Safety Policies & Procedures

- 3.1 Safety Policies & Procedures
- 3.2 Child Abuse Policy & Procedure
- 3.3 Sexual Harassment Policy & Procedure
- 3.4 Suspension and Expulsion / Due Process
- 3.5 Dress and Groom Policy
- 3.6 Employee Security Policy
- 3.7 School site emergency supplies
- 3.8 Emergency Radio

SECTION 4: Emergency Disaster Procedures & Drills

- 4.1 Emergency Disaster Procedures & Drills
- 4.2 Emergency Lockdown
- 4.3 Fire and Earthquake Drill Schedule
- 4.4 Emergency Evacuation: Principal's check list
- 4.5 Emergency Evacuation: Teacher's check list

SECTION 5: Chain of Command

- 5.1 Chain of Command
- 5.2 School Site Chain-of-Command Organization Chart

SECTION 6: Safe Ingress and Egress

- 6.1 Safe Ingress and Egress
- 6.2 Special Needs Students
- 6.3 On Campus Evacuation Map
- 6.4 Off Campus Evacuation Map

SECTION 7: OUSD Emergency Response and Notification Protocol

- 7.1 OUSD Emergency Response and Notification Protocol

SECTION 8: Afterschool Program

- 8.1 Site Profile & Special Needs Students
- 8.2 Fire and Earthquake Drill Schedule
- 8.3 School Site Chain-of-Command Organization Chart

APPENDIX

Planning for Special Needs Students

School Quality Standards relevant to this Strategic Priority

A quality school...

- is a safe and healthy center of the community, open to community use before, during, and after the school day (Standard 2.1)
- offers a coordinated and integrated system of academic and learning support services, provided by adults and youth(Standard 2.2)
- identifies at-risk students and intervenes early, to help students and their parents develop concrete plans for the future (Standard 2.5)
- creates an inclusive, welcoming and caring community, fostering communication that values individual/cultural differences(Standard 2.6)

Section 1: School Safety / Climate Team

The school site safety team or committee shall be composed of the following members: the principal or designee, one teacher who is a representative of the recognized certificated employee organization, one parent/guardian whose child attends the school, one classified employee who is a representative of the recognized classified employee organization, other members if desired. (Ed Code 32281)

Site Responsibilities:

1. Establish School Safety/Climate Team
2. Update your site map including evacuation routes
3. Create a School Site Safety Plan including:
 - Strategies for improving school safety/climate: goals, data, timeline, evaluation
 - Fire Earthquake Drill Schedule - Once per month at the elementary and middle school level, and two times per year at the high school
 - Lockdown Drill - Twice per year (once a semester)
 - Update School Phone Tree
4. Update the templates in this section of the plan to reflect current areas of responsibilities at your site: (1) Incident Command Team, (2) Goals, Strategies and Activities for School Climate and Physical Environment
5. Work closely with the school site council. Remember the school site council has the responsibility of approving the final plan and must be involved it's development.
6. Submit your Site Safety Plan to the Oakland School Police Department for review and Board submission/approval.

● Principal or Designee:	ROMA GROVES - PRINCIPAL ELEMENTARY SMALL
● Teacher:	JANET CONNORS - TEACHER STRUCTURED ENG IMMERSN
● Classified:	REGINA BROOKS-DAY - INTERVENTION SPECIALIST
● Parent Representative:	Toni Hamilton - Parent

Emergency Telephone Number Directory

	Name	Home	Work	Cell
● Principal:	ROMA GROVES - PRINCIPAL ELEMENTARY SMALL	510-262-9594	510-874-3381	510-684-6811
● Assistant Principal:	CORIGAN MALLOY - 10 MONTH CLASSROOM TSA	510-913-2842	510-874-3381	510-913-8342
● Custodian:	ANTON WALKER - CUSTODIAN	510-213-3139	510-874-3381	510-213-3139
● Secretary/Other:	INEZ WATKINS - SECRETARY ELEMENTARY SMALL	510-706-7645	510-874-3381	510-706-7645

Section 2: School Safety Plan Goals

The school safety committee shall make an assessment of the current status of school crime committed on campus and at school-related functions and of appropriate strategies and programs that will provide or maintain a high level of school safety. (Ed Code 32282)

To be considered:

- Office referrals
- Suspensions
- Expulsions
- Attendance
- Notice of Truancy Letters
- CHKS student and staff data results
- California Safe Schools Assessment
- Surveys
- Observations
- Student and Parent input
- Staff input; including School Safety Officers

Based on data analysis, the Safety/Climate Team identifies one or two safety related goals for the next school year as well as the strategies and/or programs that will be used to meet those goals. The objective is to provide meaningful goals in order to improve the campus climate. **At least one goal must be based on current school crime statistics.** Must address the following areas:

- Discipline
- Voluntary Resolution Plan & Equity Issues
- Attendance
- Parent Involvement

Goal 1: To reduce the number of chronic absences by 20%.

- Strategy 1.1: To conduct weekly parent meetings with the parents of the students who are chronically absent to provide support in getting their children to school on time.
- Strategy 1.2: To establish an incentive program for parents whose students are chronically absent.

Goal 2: To increase student leadership and engagement in all aspects of the school. (Reduce bullying)

- Strategy 2.1: To establish a student council where students can address concerns and solutions to school site issues.
- Strategy 2.2: To establish a Conflict Resolution program conducted by students to resolve peer to peer issues and concerns.

Section 3: Safety Policies & Procedures

Policies and Procedures

Child Abuse

Sexual Assault (Child assaulted on or near school property):

Accompany victim to safe place at school and remain with her/him

Protect evidence of sexual assault

Notify Child Protective Services (CPS), and Police without delay

Notify district police and school nurse or appropriate staff immediately

Sexual Abuse (Suspicion of past sexual incidents):

Notify CPS and describe evidence

Notify district police and school nurse or appropriate staff immediately. (Staff should not treat unless the victim's life is threatened)

Leave notification of family to CPS or the Police

Do not Destroy Evidence of Sexual Abuse:

Do not wash clothes or victim's body or underwear. Do not have victim undress.

Do not allow victim to wash or wipe body

Do not wipe away dirt, semen or dried blood

Stay with the victim and reassure her/him of safety

Suspected Physical Abuse or Significant Neglect:

Notify appropriate staff and CPS immediately.

Notify CPS and describe evidence. CPS will advise you of next steps. Follow their directions.

Notify immediate director/supervisor

Child Protective Services (CPS) Crisis Line (510) 259-1800

Remember: Failure to report a suspected incident of child abuse, within 48 hours can result in criminal prosecution. Protect the victim and protect yourself.

Sexual Harassment

The Governing Board prohibits sexual harassment of district employees and job applicants. The Board also prohibits retaliatory behavior or action against district employees or other persons who complain, testify or otherwise participate in the complaint process established pursuant to this policy and the administrative regulation. The Superintendent or designee shall take all actions necessary to ensure the prevention, investigation and correction of sexual harassment, including but not limited to:

1. Providing periodic training to all staff regarding the district's sexual harassment policy, particularly the procedures for filing complaints and employees' duty to use the district's complaint procedures in order to avoid harm.
2. Publicizing and disseminating the district's sexual harassment policy to staff.
3. Ensuring prompt, thorough and fair investigation of complaints.
4. Taking timely and appropriate corrective/remedial actions after completion of investigation. This may require interim separation of the complainant and the alleged harasser, and subsequent monitoring of developments.

Any district employee or job applicant who feels that he/she has been sexually harassed, or who has knowledge of any incident of sexual harassment by or against another employee, a job applicant or a student, shall immediately contact his/her supervisor, the principal, district administrator or Superintendent to obtain procedures for filing a complaint. Complaints of sexual harassment shall be filed in accordance with AR 4031 - Complaints Concerning Discrimination in Employment.

An employee may bypass his/her supervisor in filing a complaint where the supervisor is the subject of the complaint.

A supervisor, principal or other district administrator who receives a harassment complaint shall promptly notify the Superintendent or designee.

All complaints and allegations of sexual harassment shall be kept confidential to the extent necessary to carry out the investigation or take other subsequent necessary action. (5 CCR 4964)

Any district employee who engages or participates in sexual harassment, or who aids, abets, incites, compels or coerces another to commit sexual harassment against a district employee, job applicant or student, is in violation of this policy and is subject to disciplinary action, up to and including dismissal.

Suspension & Expulsion/Due Process

The Governing Board has established policies and standards of behavior in order to promote learning and protect the safety and well-being of all students. When these policies and standards are violated, it may be necessary to suspend or expel a student from regular classroom instruction.

Suspended or expelled students shall be excluded from all school-related extracurricular activities during the period of suspension or expulsion.

Except where suspension for a first offense is warranted in accordance with law, suspension shall be imposed only when other means of correction fail to bring about proper conduct. (Education Code 48900.5)

Expulsion is an action taken by the Board for severe or prolonged breaches of discipline by a student. Except for single acts of a grave nature, expulsion is used only when there is a history of misconduct, when other forms of discipline, including suspension, have failed to bring about proper conduct, or when the student's presence causes a continuing danger to him/herself or others. (Education Code 48915)

The grounds for suspension and expulsion and the procedures for considering, recommending and/or implementing suspension and expulsion shall be specified in administrative regulation.

Student Due Process

The Board does not support a zero tolerance approach. The Board shall provide for the fair and equitable treatment of students facing suspension and expulsion by affording them their due process rights under the law. The Superintendent or designee shall comply with procedures for notices and appeals as specified in administrative regulation and law. (Education Code 48911, 48915, 48915.5)

On-Campus Suspension Program

The Board recognizes that students who are suspended from school often have no supervision or guidance during the school hours when they are off campus and may fall behind in the coursework. The Board believes that, in many cases, it would be better to manage the student's behavior by keeping the student at school and providing him/her with supervision that is separated from the regular classroom.

The Superintendent or designee shall establish a supervised in-house suspension program which meets the requirements of law for suspended students who pose no imminent danger or threat at school and for whom an expulsion action has not been initiated.

The Superintendent or designee shall examine alternatives to off-campus suspension and may establish a suspension program which involves progressive discipline during the school day on campus; use of conferences between staff, parents/guardians and students; detention; student study teams or other assessment-related teams; and/or referral to school support services staff. The use of such alternatives does not preclude off-campus suspensions.

Required Parental Attendance

The Board believes that parental involvement plays an important role in the resolution of classroom behavior problems. The Board expects that teachers will communicate with parents/guardians when behavior problems arise.

Whenever a student is removed from a class because he/she committed an obscene act, engaged in habitual profanity or vulgarity, disrupted school activities or otherwise willfully defied valid staff authority, the teacher of the class from which the student was removed may provide that the student's parent/guardian attend a portion of a school day in that class. After completing the classroom visit and before leaving school premises, the parent/guardian also shall meet with the principal or designee. (Education Code 48900.1)

The Board encourages teachers, before requiring parental attendance, to make reasonable efforts to have the parent/guardian visit the class voluntarily. The teacher also may inform the parent/guardian about available resources and parent education opportunities. Teachers should reserve the option of required parental attendance for cases in which they have determined that it is the best strategy to promote positive interaction between the student and the parent/guardian and to improve classroom behavior.

The teacher shall apply this policy uniformly to all students within the classroom. This policy shall apply only to a parent/guardian who lives with the student. (Education Code 48900.1)

Parental attendance may be requested on the day the student returns to class or within one week thereafter. The principal or designee shall contact any parents/guardians who do not respond to the request to attend school. The Board recognizes that parental compliance with this policy may be delayed, modified or prevented for reasons such as serious illness/injury/disability, absence from town, or inability to get release time from work.

District regulations and school-site rules for student discipline shall include procedures for implementing parental attendance requirements.

Decision Not to Enforce Expulsion Order

On a case-by-case basis, the enforcement of an expulsion order may be suspended by the Board pursuant to the requirements of law.

Grounds for Suspension and Expulsion

A student may be subject to suspension or expulsion when it is determined that he/she:

1. Caused, attempted to cause, or threatened to cause physical injury to another person or willfully used force or violence upon the person of another, except in self-defense. (Education Code 48900(a))

A student who aids or abets the infliction or attempted infliction of physical injury on another person, as defined in Penal Code 31, may be suspended, but not expelled. However, a student may be suspended or expelled pursuant to Education Code 48900(a) once he/she has been adjudged by a juvenile court to have committed, as an **aider** or abettor, a crime of physical violence in which the victim suffered great or serious bodily injury. (Education Code 48900(q))

2. Possessed, sold, or otherwise furnished any firearm, knife, explosive, or other dangerous object unless, in the case of possession of any object of this type, the student had obtained written permission to possess the item from a certificated school employee, with the principal or designee's concurrence. (Education Code 48900(b))

3. Unlawfully possessed, used, sold, or otherwise furnished, or was under the influence of, any controlled substance as defined in Health and Safety Code 11053-11058, alcoholic beverage, or intoxicant of any kind. (Education Code 48900(c))

4. Unlawfully offered, arranged, or negotiated to sell any controlled substance as defined in Health and Safety Code

11053-11058, alcoholic beverage or intoxicant of any kind, and then sold, delivered or otherwise furnished to any person another liquid, substance or material and represented same as controlled substance, alcohol beverage or intoxicant. (Education Code 48900(d))

5. Committed or attempted to commit robbery or extortion. (Education Code 48900(e))

6. Caused or attempted to cause damage to school property or private property. (Education Code 48900(f))

7. Stole or attempted to steal school property or private property. (Education Code 48900(g))

8. Possessed or used tobacco or any products containing tobacco or nicotine products, including but not limited to cigars, cigarettes, miniature cigars, clove cigarettes, smokeless tobacco, snuff, chew packets and betel. This restriction shall not prohibit a student from using or possessing his/her own prescription products. (Education Code 48900(h))

9. Committed an obscene act or engaged in habitual profanity or vulgarity. (Education Code 48900(i))

10. Unlawfully possessed or unlawfully offered, arranged, or negotiated to sell any drug paraphernalia, as defined in Health and Safety Code 11014.5. (Education Code 48900(j))

11. Disrupted school activities or otherwise willfully defied the valid authority of supervisors, teachers, administrators, other school officials, or other school personnel engaged in the performance of their duties. (Education Code 48900(k))

12. Knowingly received stolen school property or private property. (Education Code 48900(l))

13. Possessed an imitation firearm, i.e., a replica of a firearm that is so substantially similar in physical properties to an existing firearm as to lead a reasonable person to conclude that the replica is a firearm. (Education Code [48900\(m\)](#))
14. Committed or attempted to commit a sexual assault as defined in Penal Code [261](#), [266c](#), [286](#), [288](#), [288a](#) or [289](#), or committed a sexual battery as defined in Penal Code [243.4](#). (Education Code [48900\(n\)](#))
15. Harassed, threatened, or intimidated a student who is a complaining witness or witness in a school disciplinary proceeding for the purpose of preventing that student from being a witness and/or retaliating against that student for being a witness. (Education Code [48900\(o\)](#))
16. Unlawfully offered, arranged to sell, negotiated to sell, or sold the prescription drug Soma. (Education Code [48900\(p\)](#))
17. Engaged in, or attempted to engage in, hazing as defined in Education Code [32050](#). (Education Code [48900\(q\)](#))
18. Made terrorist threats against school officials and/or school property. (Education Code [48900.7](#))

A student in grades 4-12 is also subject to suspension or recommendation for expulsion when it is determined that he/she:

19. Committed sexual harassment as defined in Education Code [212.5](#) (Education Code [48900.2](#))
20. Caused, attempted to cause, threatened to cause, or participated in an act of hate violence as defined in Education Code [233](#) (Education Code [48900.3](#))
21. Intentionally engaged in harassment, threats or intimidation against district personnel or students that is sufficiently severe or pervasive to have the actual and reasonably expected effect of materially disrupting **classwork**, creating substantial disorder, and invading the rights of school personnel or students by creating an intimidating or hostile educational environment (Education Code [48900.4](#))

Nondiscrimination/Harassment

A student may be suspended or expelled for any of the acts listed above if the act is related to school activity or school attendance occurring at any district school under the jurisdiction of the Superintendent or principal or within any other school district, including but not limited to the following circumstances: (Education Code [48900](#))

1. While on school grounds
2. While going to or coming from school
3. During the lunch period, whether on or off the school campus
4. During, going to, or coming from a school-sponsored activity

The Superintendent or principal may use his/her discretion to provide alternatives to suspension or expulsion for a student subject to discipline under this administrative regulation, including, but not limited to, counseling and an anger management program. (Education Code [48900\(r\)](#))

Alternatives to suspension or expulsion shall be used with students who are truant, tardy, or otherwise absent from assigned school activities.

Notifications to Law Enforcement Authorities

Prior to the suspension or expulsion of any student, the principal or designee shall notify appropriate city or county law enforcement authorities of any student acts of assault which may have violated Penal Code [245](#). (Education Code [48902](#))

The principal or designee also shall notify appropriate city or county law enforcement authorities of any student acts which may involve the possession or sale of narcotics or of a controlled substance or possession of weapons or firearms in violation of Penal Code [626.9](#) and [626.10](#). (Education Code [48902](#))

Within one school day after a student's suspension or expulsion, the principal or designee shall notify appropriate city or county law enforcement authorities, by telephone or other appropriate means, of any student acts which may violate Education Code [48900\(c\)](#) or (d), relating to the possession, use, offering or sale of controlled substances, alcohol or intoxicants of any kind. (Education Code [48902](#))

Outcome Data

The Superintendent or designee shall maintain the following data and report such data annually to the California

Department of Education, using forms supplied by the California Department of Education: (Education Code [48900.8](#), [48916.1](#))

1. The number of students recommended for expulsion
2. The specific grounds for each recommended expulsion
3. Whether the student was subsequently expelled
4. Whether the expulsion order was suspended
5. The type of referral made after the expulsion
6. The disposition of the student after the end of the expulsion period

Dress and Grooming

The Governing Board believes that appropriate dress and grooming contribute to a productive learning environment. The Board expects students to give proper attention to personal cleanliness and to wear clothes that are suitable for the school activities in which they participate. Students' clothing must not present a health or safety hazard or a distraction which would interfere with the educational process.

The Board of Education seeks to provide educational experiences which assure that students are academically prepared, that they accept civic and social responsibilities and that they are qualified for future entry into the work place. The clothing and accessories worn by students and staff should reflect the serious goals of an academic environment.

Students and parents/guardians shall be informed about dress and grooming standards at the beginning of the school year and whenever these standards are revised. A student who violates these standards shall be subject to appropriate disciplinary action.

Gang-Related Apparel

In accordance with the California Constitution, all students and staff of public primary, elementary, junior high and senior high schools have a right to attend campuses which are safe, secure and peaceful. Where there is evidence of a gang presence that disrupts or threatens to disrupt the school's activities, the Board of Education authorizes the principal, staff and parents/guardians at the school to establish a reasonable dress code that prohibits students from wearing gang-related apparel.

Such a dress code may be included as part of the school safety plan and must be presented to the Board for approval. The Board shall approve the plan upon determining that it is necessary to protect the health and safety of the school's students.

Uniforms

In order to promote student safety and discourage theft, peer rivalry and/or gang activity, the principal, staff and parents/guardians at a school may establish a reasonable dress code requiring students to wear uniforms. Such a dress code may be included as part of the school safety plan and must be presented to the Board for approval. The Board shall approve the plan upon determining that it is necessary to protect the health and safety of the school's students.

If a school's plan to require uniforms is adopted, the Superintendent or designee shall establish procedures whereby parents/guardians may choose to have their children exempted from the school uniform policy. Students shall not be penalized academically, otherwise discriminated against or denied attendance to school if their parents/guardians so decide. The Superintendent or designee shall ensure that resources are identified to assist economically disadvantaged students in obtaining uniforms.

Employee Security

The Superintendent or designee shall ensure that employees are informed, in accordance with law, regarding crimes and offenses by students who may pose a danger in the classroom. When violence is directed against an employee by any individual and the employee so notifies the Superintendent or designee, the Superintendent or designee shall take steps to ensure that appropriate legal measures are instituted. When the employee notifies the Superintendent or designee of a threat of bodily harm, the district shall take appropriate measures to enable the employee to request assistance if a threat occurs on school grounds.

The Superintendent or designee shall ensure that employees are trained in crisis prevention and intervention techniques in order to protect themselves and students. Staff development may include training in classroom management, effective communication techniques and crisis resolution. The Board requires school employees to take immediate action upon being made aware that any person is in possession of an injurious object on school grounds or at a school-related or school-sponsored activity. The employee shall use his/her own judgment as to the dangerousness of the situation and, based upon this analysis, shall do one of the following:

1. Confiscate the object and deliver it to the principal immediately.
2. Immediately notify the principal, who shall take appropriate action.
3. Immediately notify the local law enforcement agency and the principal.

When informing the principal about the possession or seizure of a weapon or dangerous device, the employee shall report the name(s) of persons involved, witnesses, location, and the circumstances of any seizure. *Pursuant to Education Code 49334, school employees who notify law enforcement regarding students or adults who are in possession of injurious objects while on school grounds or under the jurisdiction of school personnel are immune from prosecution.*

School Site Emergency Supplies

PURPOSE: every classroom should have a yellow **stormcase** iM2500 emergency roll kit. The equipment provided should only be used **in the event of a disaster emergency**, do not open the sealed box inside the kit. The contents are adequate to sustain a classroom of 25 students until more help arrives.

CONTENTS INCLUDE:

- 60 Individually Wrapped Water Packets.
- 2 - 2400 Calorie Food Bars - these items have a five-year shelf life.
- Users are instructed not to distribute food or water for the first 6-8 hours unless medically necessary. Water may also be used for first aid purposes.
- Basic First Aid Kit General supplies are provided with a First Aid Guidebook.
- 6-Mylar Blankets - (1) blanket is included in the Sanitation Kit to be used as a privacy screen. (5) separately packed 52" x 84" blanket - use for first aid, to cover broken windows, slow smoke or dust seeping through air vents, or group students together to provide warmth.
- Two 10-Hour Light Sticks In the event of a power outage or if students are entrapped through the night, the light sticks will provide enough light for the teacher in charge to keep the group secure.
- One Sanitation Kit including:
 - 6-Trash Bag Liners
 - 1-Bio-Hazard Bag
 - 6-Cleansing Wipes
- Packet of Fluid Solidifier -this packet is wrapped individually and contains instructions.
- One collapsible toilet, sturdy enough to support 250 pounds. Teachers may not have restroom facilities available. This unit is equipped with a toilet and should be assembled in the event of long term entrapments or lockdowns. Complete instructions are provided.

Monthly Emergency Radio Testing

Monthly emergency radio testing is on the first Wednesday of every month at 9:00 am. Emergency radio should be on Channel 1, OUSD Area A. When your school name is called, please respond with the following script: "This is {your name} responding for {school name} elementary, middle or high school. Our OUSD LID # is ____ {this can be found at the bottom of radio} - we are all clear."

Section 4: Emergency Disaster Procedures and Drills

Earthquake Procedures

In the classroom or office

At the first indication of ground movement, you should **DROP** to the ground. It will soon be impossible to stand upright during the earthquake. Getting to the ground will prevent being thrown to the ground. You should seek protective **COVER** under or near desks, tables, or chairs in a kneeling or sitting position. You should **HOLD** onto the table or chair legs. Holding onto the legs will prevent it from moving away from you during the quake. Protect your eyes from flying glass and debris with your arm covering your eyes.

You should remain in the DROP position until ground movement ends. Be prepared to DROP, COVER and HOLD during aftershocks.

After ground movement ends, check for injuries and safely evacuate the building. Move to a safe, open area, away from power lines and other overhead hazards.

Earthquake procedures in other parts of the building

At the first indication of ground movement, you should DROP to the ground. Take COVER under any available desk, table, or bench. If in a hallway, drop next to an inside wall in a kneeling position and cover the back of the neck with your hands. After ground movement ends, check for injuries and safely evacuate the building. Move to a safe, open area, away from power lines and other overhead hazards.

Earthquake procedures while outside

At the first indication of ground movement, move away from overhead hazards such as power lines, trees, and buildings. DROP to the ground and COVER the back of the neck with your hands. Be aware of aftershocks. Do not re-enter buildings until it is determined safe to do so.

While in a vehicle, you should pull over to the side of the road and stop. If you are on a bridge, overpass, or under power lines, continue on until you are away from the overhead dangers. Wait until the ground movement stops and check for injuries. Be aware of after shocks, downed wires, or roads blocked by debris.

Fire Procedures

- Evacuate the buildings immediately for any fire or suspected fire.
- Sound alarm if it has not already been done.
- Call 9-1-1**, identify problem, school building address and location of fire (if known).

Never attempt to fight a fire larger than a wastebasket size. Even a small fire can generate enough smoke to cause serious injury. Never attempt to fight a fire by yourself. Call for help. Always stay between the fire and the exit.

Fire Extinguisher Instructions:

- P Pull safety pin from the handle
- A Aim at the base of the fire
- S Squeeze the trigger handle
- S Sweep from side to side

If your clothes (or someone else's) catch fire, STOP, DROP AND ROLL!

- Upon arrival, the Fire Department will assume command.
- Principal will be accountable for teachers and school district staff. Teachers will be accountable for students.
- Notify State Administrator's Office of incident.

Emergency Lockdown

If it is determined that the safety and health of students and staff are in jeopardy, an announcement will be made to alert of potential danger. The Shelter-In-Place alert shall be given by the District.

The announcement will be: "MR. (school name), PLEASE COME TO THE PRINCIPALS'S OFFICE!" A messenger must be sent to outdoor fields and tracks. Upon hearing this announcement, the following steps must be implemented:

- Teachers should quickly check halls and get students into classrooms.
- Lock doors, close blinds.
- Teachers will keep all students in the classroom until an all clear has been sounded.
- Teachers will maintain (as best they can) a calm atmosphere in the classroom, keeping alert to emotional needs of students.
- Staff without students will report to the office for instruction or as otherwise directed.
- Head secretary will operate the phones and radio. Other clerical staff will deliver messages as needed and work with Principal and Police Services.
- Staff will not evacuate or leave their assigned area unless authorized by Principal or Police Services.
- When the emergency is over, a coded "all clear" will be announced.
- The Crisis Response Team will meet to determine needs of school.
- Each staff member will document exactly what occurred in their area of responsibility. This will be done as soon as possible.

Shelter-in-Place

When instructed or when an alerting system triggers to shelter-in-place, please:

- SHELTER.** Go inside the nearest building or classroom and remain there. You are looking for enclosed protection from the outside.
 - Students should also be advised to do the following when possible:
 - Select rooms on higher floor levels and avoid basements.
 - Select an internal room or a room with as few windows as possible.
 - Choose a room with bathroom facilities and water. You may need to shelter in place for an extended period of time.
- SHUT.** Close all doors and windows. The tighter and more complete the seal the better. Close as many windows and doors between the outside and your shelter-in-place room as possible. Close curtains and then stay away from the windows.
- LISTEN.** Remain quiet to hear critical instructions from school officials.

Section 4: Emergency Lockdown

The announcement will be: "Mr. Safeway is at (Martin Luther King, Jr. Elementary School), PLEASE COME TO THE PRINCIPAL'S OFFICE!"

Section 4: Fire and Earthquake Drill Schedule

Fire and Earthquake Drill Schedule

Month	Date	Time	Fire/Earthquake
September	9/15/2015	9:30 AM	Fire
September	9/17/2015	9:30 AM	EQ
October	10/13/2015	1:15 PM	Both
November	11/17/2015	9:30 AM	Fire
November	11/19/2015	1:30 PM	EQ
December	12/17/2015	1:15 PM	Both
January	1/26/2016	9:30 AM	Both
February	2/18/2016	1:15 PM	Fire
February	2/23/2016	9:30 AM	EQ
March	3/15/2016	1:15 PM	Both
April	4/19/2016	9:30 AM	Both
May	5/17/2016	1:30 PM	Fire
May	5/19/2016	9:30 AM	EQ
June	6/7/2016	9:30 AM	Both

Lockdown Drill Schedule

	Date	Time
Fall	12/15/2015	1:15 PM
Spring	4/21/2016	9:30 AM

Emergency Evacuation: Principal's checklist

- Determine appropriate evacuation areas that have been pre-designated.
- Activate alarm/PA system or send message runner.
- Telephone emergency service personnel:
 - **9-911**
 - **Superintendent's office**
 - **Utilities**

Activate key personnel to:

- Attend to the injured.
- Assure complete evacuation and student/staff are accounted for.
- Ensure special needs students are evacuated accordingly.
- Secure school for specific emergency.
- Clear road/fire lanes for emergency vehicles (pre-assigned).
- Assure that injured students/staff are reported to medical services for care and transportation to hospital/emergency medical center.
- Be contact person for emergency services, District, utility and/or news media personnel and provide needed aid (pre-assigned).
- Direct employees to aid those from the emergency services, District, utilities and other authorities. Avoid entering damaged areas unless specifically asked.
- Assure the facility is thoroughly inspected by the custodian, fire officials and District Operation personnel before re-entry is allowed.
- Seek Superintendent or designee/Assistant Superintendents approval for school closure if damage cannot be immediately restored or repaired.
- If possible, have students/staff re-enter parts of the school that are declared safe.
- Make sure all students/staff are accounted for once outside.

Emergency Evacuation: Employees checklist

- Upon emergency alert, secure work area as advised and depart/report to assigned area.
- Perform duties as pre-assigned by the Principal in cooperation with emergency services personnel.
- DO NOT re-enter the building without permission or request of emergency service authorities.
- Remain in the general assembly areas and calm students if not assigned another duty.
- If dismissed, inform Principal of departure.
- When signaled to re-enter safe areas of the school, quickly do so.
- Upon safe re-entry, report anything amiss to the Principal.

Emergency Evacuation: Teachers checklist

- Upon alert, assemble students for evacuation using designated routes and account for all students
- Secure room as advised
- Upon arrival at the assembly area, account for all students.
- Secure medical treatment for injured students.
- Report any students missing or left behind because of serious injuries.
- Stay with and calm students.
- If closure is ordered with no re-entry, when advised, release walkers and car/passengers (unless drivers are needed to evacuate students from the site) accounting for those who have left. Stay with bus riders until buses arrive.
- If signaled to re-enter school, assure students do so quickly and calmly. Account for all students.
- Check room and report anything amiss to the Principal.
- Debrief students to calm fears about the evacuation.

If it is necessary to evacuate to another school or relief center, the Principal will:

- Contact the Superintendent or designee.
- Cooperate with emergency authorities in enlisting students/staff with cars to help transport evacuees.
- Direct the evacuation, assure all students/staff are accounted for as they depart and arrive.

Emergency Student Release Procedures

1. The Oakland Unified School District will keep and care for all students in an emergency situation (such as loss of electrical power, wind/rain storms, earthquakes, etc.) until the end of the school day or longer if the emergency dictates.
2. It should be noted that elementary students will not be sent home during normal school hours because of an emergency. However, in order to avert adverse affects on elementary level bus transportation, secondary students may be dismissed early.
3. Should conditions exist that make transportation impossible, students will be kept at school until the parent, guardian or an authorized adult comes to check the student out of school. In such conditions it is expected that parents/authorized adults will come as soon as possible to pick up their student(s).
4. If electrical power has not been disrupted, only high school parents/legal guardians may have their student(s) released, as per normal absence/release procedures.
5. In all situations, the superintendent may make other decisions dependent on the type of emergency. During any community-wide emergency, please listen to the radio for pertinent information.
6. Those who arrive during an emergency to check a student out of school will go through the designated release procedures: typically the school will record the time, student's name, and the name of adult to whom the student is being released and address or destination.

If the emergency situation does not extend beyond normal school hours, students will be released as usual at the end of the school day.

Section 5: Chain of Command

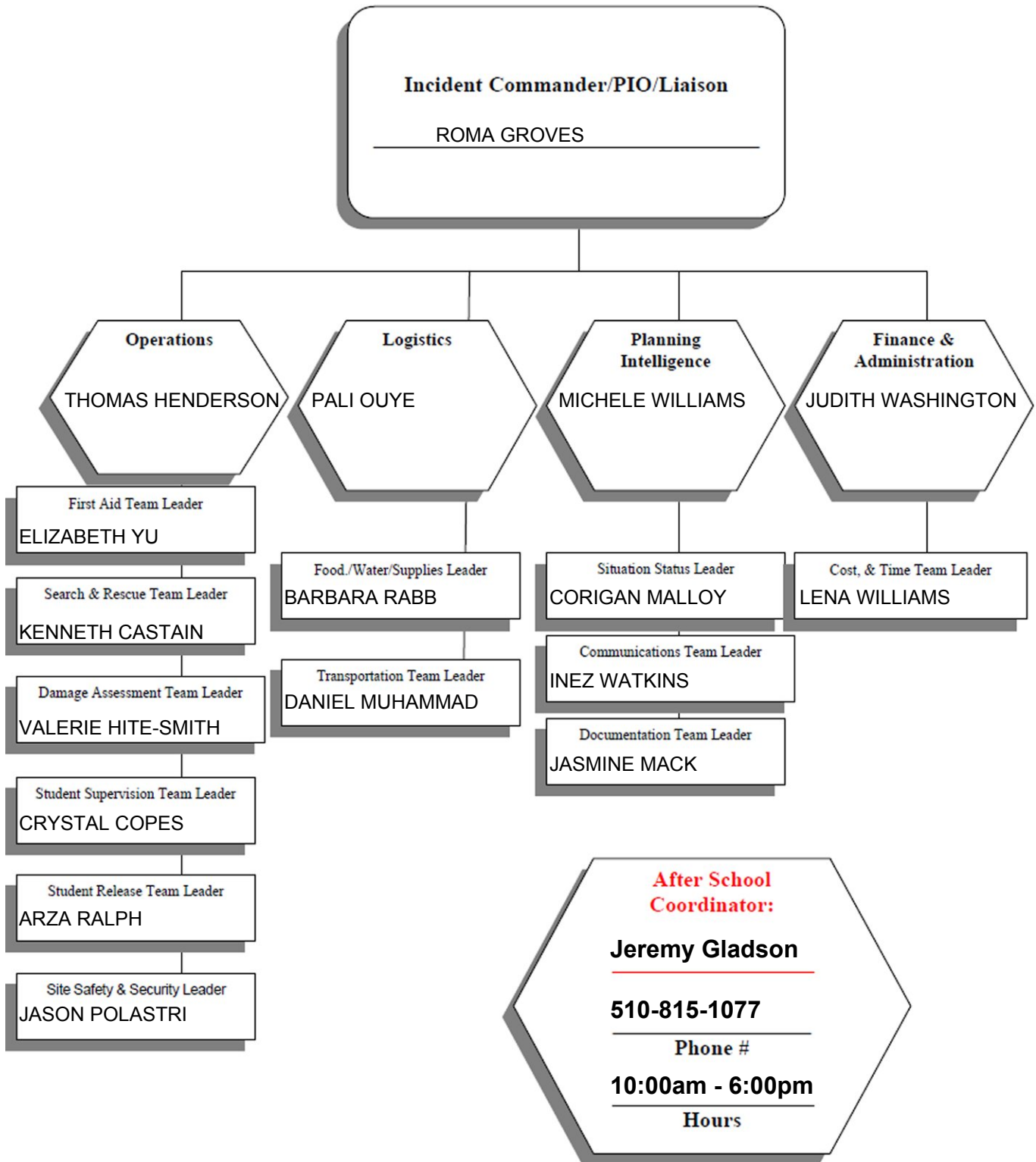

Section 6: Safe Ingress and Egress

Your OUSD LID Radio Number.

Beyond planning for daily ingress/egress routes and emergency evacuation routes, schools must plan for assisting students, staff and visitors with disabilities. Under the ADA (Americans with Disabilities Act of 1990), individuals who are deaf/hard of hearing, blind/partially sighted, mobility impaired and/or cognitively/emotionally impaired must be assisted.

A. Plan for people with disabilities (ADA) **N/A**(Note: If you do not have any special needs populatoins at your school, please click NA box.)

Please include the following information: 1) How many students with disabilities are there? 2) Where are they located? 3) Description of disabilities. 4) Any other relevant info

There are 49 students with diverse disabilities. The students are in the following classrooms: C - 2, A - 1, A - 5; B - 6, & E - 1. The disabilities are cognitively and emotional impaired based on the student IEPs.

Special Needs Population In Detail.

List the specific number of each special needs type on site.

Special Needs Type	Abbreviation	Total
Intellectually Disabled	ID	<input type="text" value="20"/>
Hard of Hearing	HH	<input type="text" value="1"/>
Deaf	DEA	<input type="text" value="0"/>
Speech & Language Impairment	SLI	<input type="text" value="40"/>
Visually Impaired	VI	<input type="text" value="0"/>
Emotionally Disturbed	ED	<input type="text" value="13"/>
Orthopedically Impaired	OI	<input type="text" value="0"/>
Other Health Impaired	OHI	<input type="text" value="5"/>
Specific Learning Disability	SLD	<input type="text" value="35"/>
Deaf / Blind	DB	<input type="text" value="0"/>
Multipally Disabled	MD	<input type="text" value="0"/>
Traumatic Brain Injury	TBI	<input type="text" value="0"/>
Est Medical Disability	EMD	<input type="text" value="0"/>

Determine proper signage and equipment.

(What equipment and signage is on-site to help people with disabilities?)

Exit signs, and rails in the main restrooms

Training staff to assist individuals with disabilities.

At least 1 name / title combination must be complete.

Name: Valerie Hite-Smith	Title: SDC K - 1 Teacher
Name: Barbara Rabb	Title: SDC 4 - 5 Teacher
Name: Arza Ralph	Title: SDC Pre - K Teacher

Section 6: On Campus Evacuation Map

Schools must identify and clearly mark "assembly location" on campus map with evacuation routes (indicated with arrows) pointing to the assembly location.

On-Campus Assembly Location

Describe on-campus evacuation/assembly location.

Play Area 1 - C2, C3, C4, A1, & A2; Play Area 2 - CDC; Parking Lot - C1 & Cafeteria; Play Area 3 - B1, B2, B3, B4, B5, & B6; Front of the School -

- Upload Copy of Map Use Last Years Map

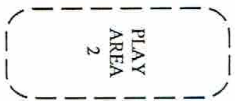
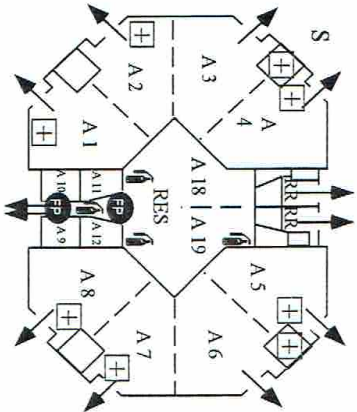
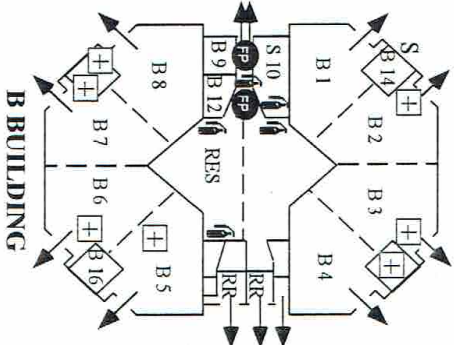
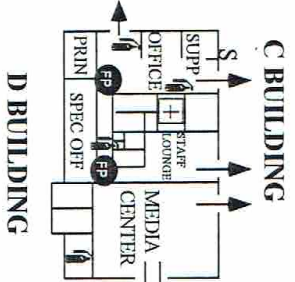
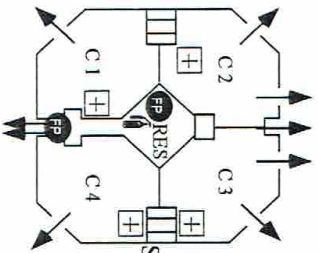
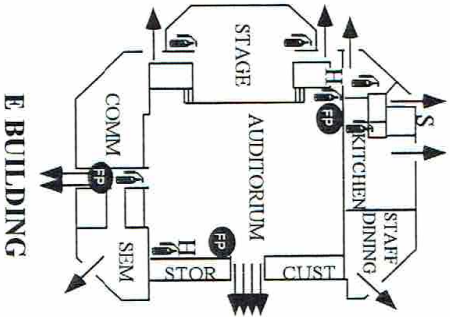

A BUILDING
PLAY YARD

- H FIRE HOSE
- S SPRINKLER PULL
- FIRE PULL
- ⊕ FIRE EXTINGUISHER
- EXIT
- ⊕ FIRST AID KIT

Not drawn to scale 2/98

MARTIN LUTHER KING, JR.
ELEMENTARY SCHOOL
960 10TH STREET
OAKLAND, CA

Drawing by
Richard Guagliardo
Professional Safety
Consultant

Section 6: Off Campus Evacuation Map

Schools must identify the location of potential evacuation sites based on the potential circumstances that may cause movement/relocation of the school population in the event of an emergency.

Off-Campus Evacuation/Assembly Location

a-1. Description/Name of location: Lowell Park

Establish a memorandum of agreement with the evacuation site.

Name of person or organization memorandum was established with:

City of Oakland

C. Date of Agreement: 5/30/2013

a-2. Please enter the Street Address of the Off-Site Campus Evacuation Location. Please don't enter the city, state, or zip code.

A. School Street Address: , Oakland, CA

B. Evacuation Street Address: , Oakland, CA

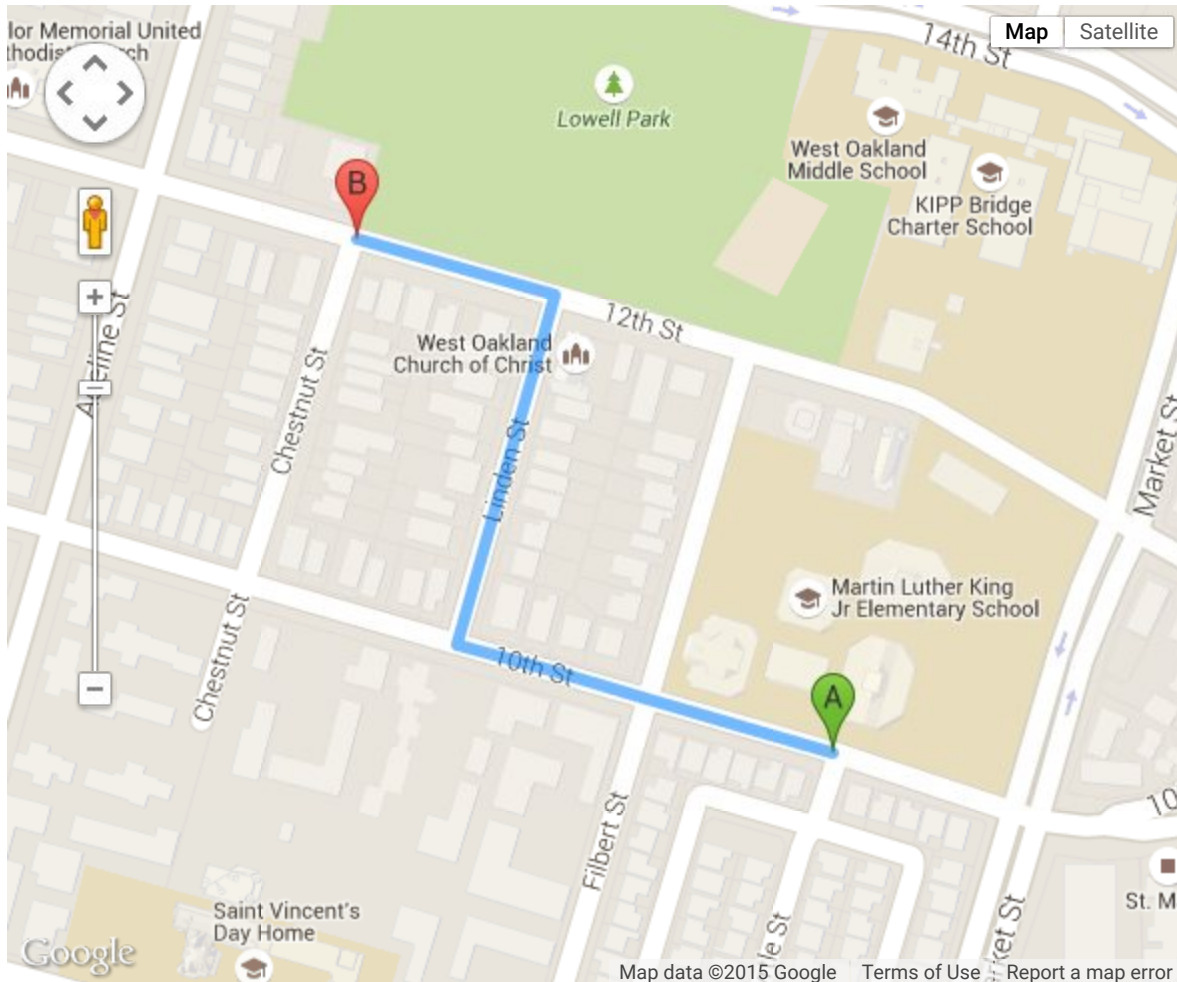

Section 7: OUSD Emergency Response and Notification Protocol

Oakland Unified School District Emergency/Crisis Response and Notification Protocol

Examples of Major Incident:

- Student Death
- Staff Death
- Health Crisis
- Violent death close to campus
- Lockdown Incident
- Major Theft
- Act of Violence
- Missing Child
- Weapons on campus

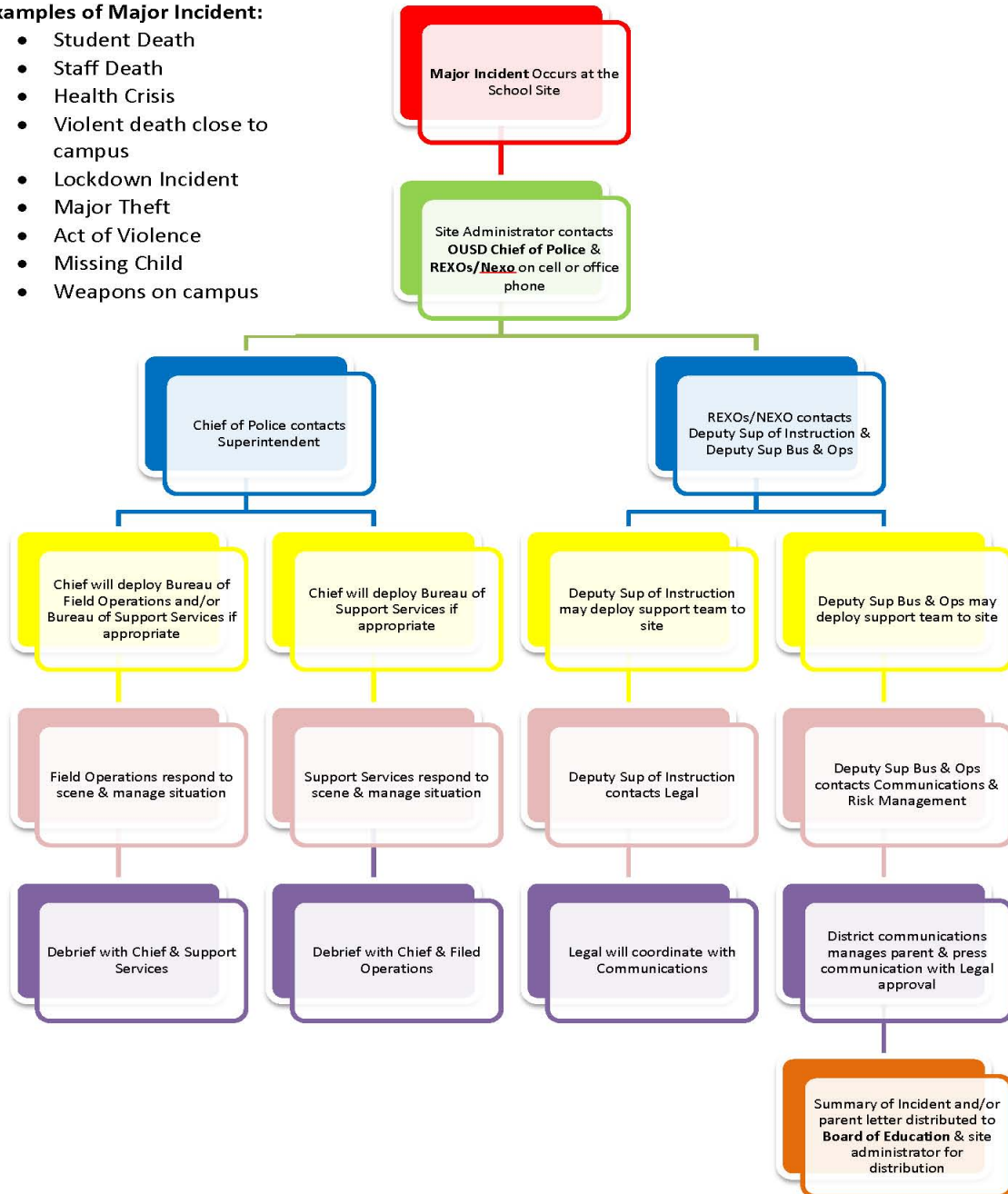

Oakland Unified School District
 Emergency/Crisis Response and Notification Protocol – Post Incident

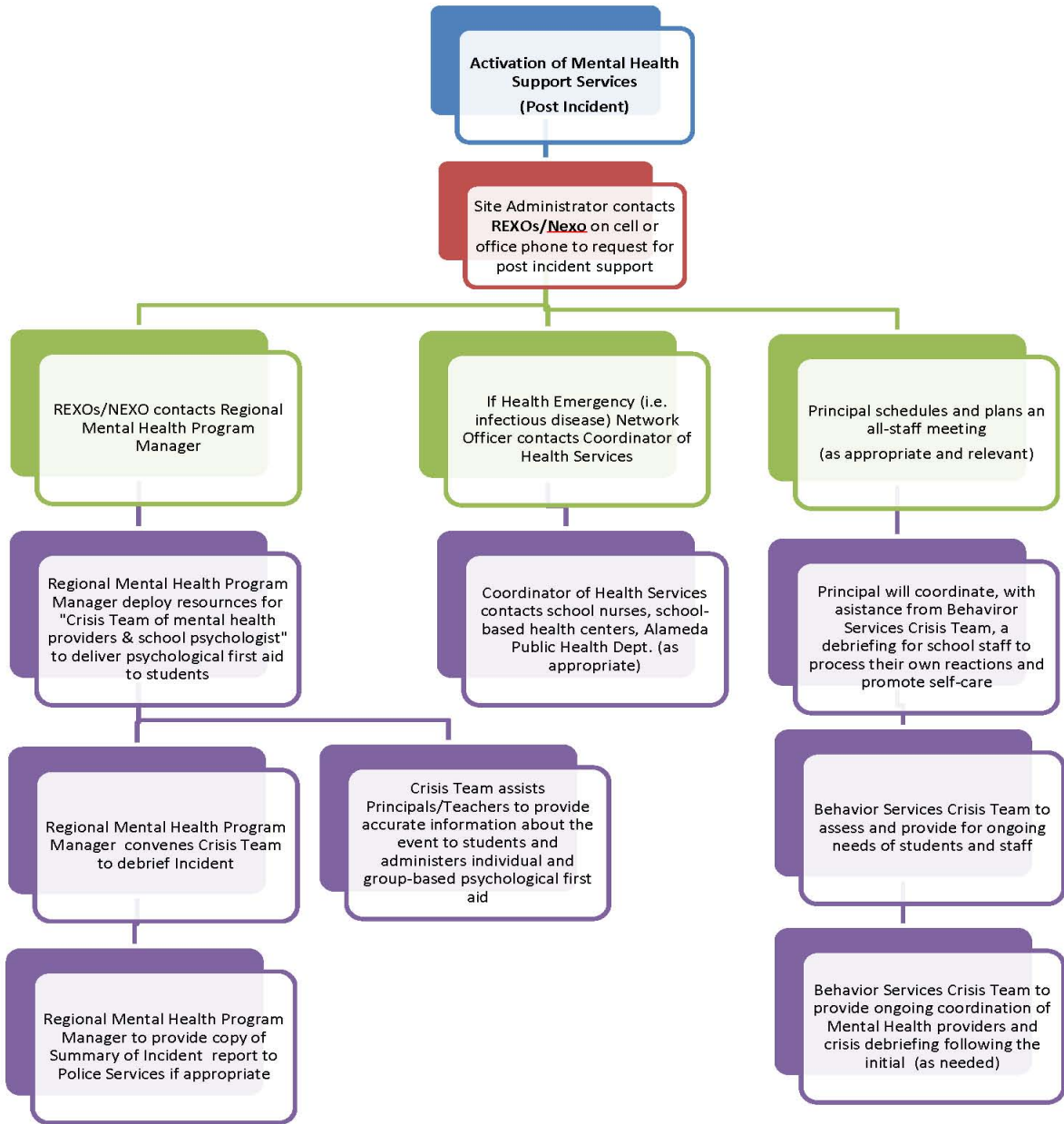

Section 8: Afterschool Program

AFTER SCHOOL PROGRAM

It is important to have a comprehensive safety plan that covers all programs on your school site during regular school hours (8:00 am – 3:00 pm) as well as after school hours (3:00 – 6:00 pm.) Please work with your 'after school coordinator' on the safety planning details to include students in after school programs.

After School Coordinator Name/Contact 1	Name: Phone:
After School Coordinator Name/Contact 2	Name: Phone:
Hours of Operation:	
# of staff:	
# of students:	
# of special needs students:	
# of special needs coordinators:	

Primary on-campus evacuation location:	
Secondary off-campus evacuation location:	
Notification sent to Parents: Yes / No	i.e. flyer, newsletter, mailer, etc. :
Emergency Staff Notification Method:	i.e. PA system, mass text, other, etc.

Student reunification policy established?	Yes / No (if no, please develop & attach policy)
Has 'after school staff on safety team' completed the mandatory ICS 100/200 training?	Yes / No (if no, please follow these 2 links to complete online: IS-100.SCa Introduction to the Incident Command System for Schools http://training.fema.gov/EMIWeb/IS/IS100SCA.asp IS-200.b (ICS 200) ICS for Single Resources and Initial Action Incidents http://training.fema.gov/emiweb/is/is200b.asp
After School Safety team established?	Yes / No
List safety team members name:	Safety team member 1: _____ Safety team member 2: _____ Safety team member 3: _____ Safety team member 4: _____ Safety team member 5: _____

AFTER SCHOOL PROGRAM

Fire and Earthquake Drill Schedule – *After School Program*

The after school coordinator shall hold at least two fire and two earthquake drills every school year. Sites are strongly encouraged to conduct both Earthquake and Fire drills on the same day when possible.

MONTH	Type of Drill	DATE	TIME
September			
October			
November			
December			
January			
February			
March			
April			
May			

NOTE: Please check this box if your site will be conducting both Earthquake & Fire drills on the same day.

Lockdown Drill Schedule – *After School Program*

The after school coordinator shall hold two lockdown drills every school year at elementary, middle and high school level.

SEMESTER	DATE	TIME
Fall		
Spring		

Monthly Emergency Drill Report Form

Month _____

Type of Drill	Time Duration	Number of Persons Evacuated	Number of Staff Supervising Drill
Earthquake			
Fire			
Lockdown			
Name of School: _____			

After School Coordinator Signature: _____ Date: _____

Please return the **completed drill form** with signature to Jenny Wong, Emergency Preparedness Program Manager via email at jenny.wong@ousd.k12.ca.us or fax 510.874.7787.

AFTER SCHOOL PROGRAM



Safety Plan Appendix

School Safety Plan

APPENDIX: Safety for Special Needs Populations

OAKLAND UNIFIED SCHOOL DISTRICT
Safety for Special Needs Populations

Safety for Special Needs Populations

Table of Contents

TABLE OF CONTENTS.....	1
AMERICAN WITH DISABILITIES ACT	2
ROLES AND RESPONSIBILITIES	2
PLANNING.....	2
NOTIFICATION.....	2
EVACUATION.....	3
SHELTERING	4
RETURNING HOME	6
EARTHQUAKE	7
BEFORE A DISASTER	8
DURING THE EARTHQUAKE.....	9
AFTER THE EARTHQUAKE	9
TRAINING FOR RESCUE SERVICE DURING AN EMERGENCY.....	10
EVACUATING WHEELCHAIR USERS	10
ALL WHEELCHAIR USERS.....	10
MANUAL (NON-MOTORIZED) WHEELCHAIRS.....	11
MOTORIZED WHEELCHAIRS.....	11

American with Disabilities Act

Title 29 CFR Part 36 implements Title III of the Americans with Disabilities Act of 1990 (42 U.S.C. 12181), which prohibits discrimination on the basis of disability by public accommodations and requires places of public accommodation and commercial facilities to be designed, constructed, and altered in compliance with the accessibility standards established by this part.

Roles and Responsibilities

One of the most important roles of local government is to protect their citizenry from harm, including helping people prepare for and respond to emergencies. Making local government emergency preparedness and response programs accessible to people with disabilities is a critical part of this responsibility. Making these programs accessible is also required by the Americans with Disabilities Act of 1990 (ADA).

Planning

If you are responsible for your community's emergency planning or response activities, you should involve people with disabilities in identifying needs and evaluating effective emergency management practices. Issues that have the greatest impact on people with disabilities include notification, evacuation, emergency transportation, sheltering, access to medical care and medications, access to their mobility devices or service animals while in transit or at shelters, and access to information.

In planning for emergency services, you should consider the needs of people who use mobility aids such as wheelchairs, scooters, walkers, canes or crutches, or people who have limited stamina. Plans also need to include people who use oxygen or respirators, people who are blind or who have low vision, people who are deaf or hard of hearing, people who have a cognitive disability, people with mental illness, and those with other types of disabilities.

Action Step:

Solicit and incorporate input from people with different types of disabilities (e.g. mobility, vision, hearing, cognitive and other disabilities) regarding all phases of your emergency management plan (preparation, notification, response, and clean up).

Notification

Many traditional emergency notification methods are not accessible to or usable by people with disabilities. People who are deaf or hard of hearing cannot hear radio, television, sirens, or other audible alerts. Those who are blind or who have low vision may not be aware of visual cues, such as flashing lights. Warning methods should be developed to ensure that all citizens will have the information necessary to make sound decisions and take appropriate, responsible action. Often, using a combination of methods will be more effective than relying on one method alone. For instance, combining visual and audible alerts will reach a greater audience than either method would by itself.

OAKLAND UNIFIED SCHOOL DISTRICT
Safety for Special Needs Populations

Action Step:

Provide ways to inform people who are deaf or hard of hearing of an impending disaster if you use emergency warning systems such as sirens or other audible alerts. When the electric power supply is affected, it may be necessary to use several forms of notification. These might include the use of telephone calls, auto-dialed TTY (teletypewriter) messages, text messaging, e-mails, and even direct door-to-door contact with pre-registered individuals. Also, you should consider using open-captioning on local TV stations in addition to incorporating other innovative uses of technology into such procedures, as well as lower-tech options such as dispatching qualified sign language interpreters to assist in broadcasting emergency information provided to the media.

Evacuation

Individuals with disabilities will face a variety of challenges in evacuating, depending on the nature of the emergency. People with a mobility disability may need assistance leaving a building without a working elevator. Individuals who are blind or who have limited vision may no longer be able to independently use traditional orientation and navigation methods. An individual who is deaf may be trapped somewhere unable to communicate with anyone because the only communication device relies on voice. Procedures should be in place to ensure that people with disabilities can evacuate the physical area in a variety of conditions and with or without assistance.

Action Step:

Adopt policies to ensure that your community evacuation plans enable people with disabilities, including those who have mobility impairments, vision impairments, hearing impairments, cognitive disabilities, mental illness, or other disabilities, to safely self-evacuate or to be evacuated by others. Some communities are instituting voluntary, confidential registries of persons with disabilities who may need individualized evacuation assistance or notification. If you adopt or maintain such a registry, have procedures in place to ensure its voluntariness, guarantee confidentiality controls, and develop a process to update the registry. Also consider how best to publicize its availability. Whether or not a registry is used, your plan should address accessible transportation needs for people who use wheelchairs, scooters, or other mobility aids as well as people who are blind or who have low vision.

OAKLAND UNIFIED SCHOOL DISTRICT
Safety for Special Needs Populations

Both public and private transportation may be disrupted due to overcrowding because of blocked streets and sidewalks, or because the system is not functioning at all. The movement of people during an evacuation is critical, but many people with disabilities cannot use traditional, inaccessible transportation.

Action Step:

Identify accessible modes of transportation that may be available to help evacuate people with disabilities during an emergency. For instance, some communities have used lift-equipped school or transit buses to evacuate people who use wheelchairs during floods.

Sheltering

When disasters occur, people are often provided safe refuge in temporary shelters. Some may be located in schools, office buildings, tents, or other areas. Historically, great attention has been paid to ensuring that those shelters are well stocked with basic necessities such as food, water, and blankets. But many of these shelters have not been accessible to people with disabilities. Individuals using a wheelchair or scooter have often been able somehow to get to the shelter, only to find no accessible entrance, accessible toilet, or accessible shelter area.

Action Step:

Survey your community's shelters for barriers to access for persons with disabilities. For instance, if you are considering incorporating a particular high school gymnasium into your sheltering plan, early in the process you should examine its parking, the path to the gymnasium, and the toilets serving the gymnasium to make sure they are accessible to people with disabilities. If you find barriers to access, work with the facility's owner to try to get the barriers removed. If you are unable to do so, consider another nearby facility for your community sheltering needs.

Until all of your emergency shelters have accessible parking, exterior routes, entrances, interior routes to the shelter area, and toilet rooms serving the shelter area, identify and widely publicize to the public, including persons with disabilities and the organizations that serve them, the locations of the most accessible emergency shelters.

OAKLAND UNIFIED SCHOOL DISTRICT
Safety for Special Needs Populations

Shelter staff and volunteers are often trained in first aid or other areas critical to the delivery of emergency services, but many have little, if any, familiarity with the needs of people with disabilities. In some instances, people with disabilities have been turned away from shelters because of volunteers' lack of confidence regarding the shelter's ability to meet their needs. Generally, people with disabilities may not be segregated or told to go to "special" shelters designated for their use. They should ordinarily be allowed to attend the same shelters as their neighbors and coworkers.

Action Step:

Invite representatives of group homes and other people with disabilities to meet with you as part of your routine shelter planning. Discuss with them which shelters they would be more likely to use in the event of an emergency and what, if any, disability-related concerns they may have while sheltering. Develop site-specific instructions for your volunteers and staff to address these concerns.

Many shelters have a "no pets" policy and some mistakenly apply this policy to exclude service animals such as guide dogs for people who are blind, hearing dogs for people who are deaf, or dogs that pull wheelchairs or retrieve dropped objects. When people with disabilities who use service animals are told that their animals cannot enter the shelter, they are forced to choose between safety and abandoning a highly trained animal that accompanies them everywhere and allows them to function independently.

Action Step:

Adopt procedures to ensure that people with disabilities who use service animals are not separated from their service animals when sheltering during an emergency, even if pets are normally prohibited in shelters. While you cannot unnecessarily segregate persons who use service animals from others, you may consider the potential presence of persons who, for safety or health Reasons, should not be with certain types of animals.

Individuals whose disabilities require medications, such as certain types of insulin that require constant refrigeration, may find that many shelters do not provide refrigerators or ice-packed coolers. Individuals who use life support systems and other devices rely on electricity to function and stay alive and, in many cases, may not have access to a generator or other source of electricity within a shelter.

Action Step:

Ensure that a reasonable number of emergency shelters have back-up generators and a way to keep medications refrigerated (such as a refrigerator or a cooler with ice). These shelters should be made available on a priority basis to people whose disabilities require access to electricity and refrigeration, for example, for using life-sustaining medical devices, providing power to motorized wheelchairs, and preserving certain medications, such as insulin, that require refrigeration. The public should be routinely notified about the location of these shelters. In addition, if you choose to maintain a confidential registry of individuals needing transportation assistance, this registry could also record those who would be in need of particular medications. This will facilitate your planning priorities.

OAKLAND UNIFIED SCHOOL DISTRICT
Safety for Special Needs Populations

People who are deaf or hard of hearing may not have access to audible information routinely made available to people in the temporary shelters. Those who are blind or who have low vision will not be able to use printed notices, advisories, or other written information.

Action Step:

Adopt procedures to provide accessible communication for people who are deaf or hard of hearing and for people with severe speech disabilities. Train staff on the basic procedures for providing accessible communication, including exchanging notes or posting written announcements to go with spoken announcements. Train staff to read printed information, upon request, to persons who are blind or who have low vision.

Returning Home

The needs of individuals with disabilities should be considered, too, when they leave a shelter or are otherwise allowed to return to their home. If a ramp has been destroyed, an individual with a mobility impairment will be unable to get into and out of the house. In case temporary housing is needed past the stay at the shelter, your emergency response plan could identify available physically accessible short-term housing, as well as housing with appropriate communication devices, such as TTY's, to ensure individuals with communication disabilities can communicate with family, friends, and medical professionals.

Action Step:

Identify temporary accessible housing (such as accessible hotel rooms within the community or in nearby communities) that could be used if people with disabilities cannot immediately return home after a disaster if, for instance, necessary accessible features such as ramps or electrical systems have been damaged.

If you contract with another entity, such as the American Red Cross or another local government, to provide your emergency preparedness plans and emergency response services, you should ensure that the other entity follows these steps on your behalf.

OAKLAND UNIFIED SCHOOL DISTRICT
Safety for Special Needs Populations

Prepare For What Will Happen

Earthquake

1. Not only do breakable things break, the broken pieces and other objects fly off walls and shelves. So, during the shaking move away from windows, mirrors, shelves, and bookcases. Watch out for pictures flying off walls, and loose objects from the top of file cabinets. Cabinet doors may open and stored items spill out; bookcases may topple over if not anchored to a wall or the floor.
2. Large, heavy furniture gets moved. This means file cabinets, desks, televisions, couches, beds and other items you may not be able to move by yourself will shift position by a foot or more. Out-of-position furniture may actually block the pathway out of your office or residence.
3. Many offices have acoustical tile ceilings, and a major quake may shake some out of the ceiling. Fortunately, tiles are not very heavy when they fall. But usually a lot of dust has accumulated above the tiles and this dust will come down as well.
4. Telephone service may be interrupted.
5. Electricity may be lost. This means no lights, air conditioning, electric heating, and elevators. Refrigerators and electric stoves will not work and you may have no hot water. Also, because of lost water pressure toilets may not flush. Without electricity you cannot run mechanical breathing aids; you will not be able to recharge a power wheelchair. Only battery operated clocks, radios, televisions, and other appliances will help you. **AT WORK AND AT HOME -KEEP A FLASHLIGHT, BATTERY OPERATED RADIO AND FRESH BATTERIES HANDY.**
6. A fire is much more possible than under normal conditions. In or near any building or residence, there may be a ruptured gas line, torn electrical wiring, or spilled flammable fluids. **AT HOME, HAVE A FIRE EXTINGUISHER HANDY. AT WORK, KNOW WHERE THE NEAREST TWO EXTINGUISHERS ARE LOCATED. KNOW HOW TO DIRECT SOMEONE TO TURN OFF YOUR GAS IF YOU CANNOT DO SO YOURSELF.**
7. Don't expect help from fire and police personnel for at least 72 hours: they will be busy with the most crucial situations. Some emergency shelters are up and running within hours of a major disaster; others take two or three days to become operational. **BE MENTALLY PREPARED TO RELY ON YOUR OWN RESOURCES AND THE HELP OF NEIGHBORS AND WORK COLLEAGUES DURING THE FIRST 72 HOURS AFTER A MAJOR EARTHQUAKE.**
8. It can take up to three days for emergency water to get to your area. Every person should store at least 3 gallons, and more for those people who need extra water. And still more if you have a service animal. It is best to store filtered water because it will stay fresher during a long storage. (Replace the water every few months.)
9. In the days following a major quake, many people find themselves easily distracted, strangely absent-minded, and occasionally losing track of keys, phone numbers, and other things. If you experience this, don't worry greatly; it is a normal reaction to the stress of a being in a major disaster.

OAKLAND UNIFIED SCHOOL DISTRICT
Safety for Special Needs Populations

10. It may take several days before order is restored and you can replace even the simplest disability related items like hearing-aid batteries and prescription medications. Keep spares and backup supplies at home or at school.

Before a Disaster

1. Evacuation plans must provide for problems involved in students with mobility, visual and hearing impairments. Special evacuation transportation provisions may be necessary - both from the school building to the assembly area(s) and away from the school area. And plans must also address assistance that will be provided to mentally retarded students during and after the earthquake.
2. Special needs students should have a back-up supply of vital medication, equipment or supplies with them, at school or enroute. Those students or their teachers should be prepared to bring the extra medication or supplies if evacuation from the school premises is ordered.
3. Parents or guardians of these students should be consulted concerning care considerations if the student is isolated at school for both a short term or long term basis.
4. These students should have in their possession an individual emergency card describing their special needs. The cards should list information such as; disability, medications and their application frequencies, mobility constraints, attendant needs allergies, primary physician, etc.
5. Any power requirements for special sustaining equipment, if normal power is off for a long period of time, should be considered.
6. Special Needs Teachers and Aids should be kept with their students.
7. Allow for individual self sufficiency of these students as much as possible by getting them involved in preparedness and response activities. Include in response planning obvious ways in which special needs students can assist others in response to disastrous conditions -include them in your drill. As an example, in the dark (due to power loss and no outside light), sighted people could depend on the blind students to navigate through debris laden evacuation routes. Blind people are experienced at being placed in new, unfamiliar environments and finding their way.
8. Also communicate preparedness and response information and instructions (according to need) to these students with braille, audio cassette, visual aids, large print, etc. Don't let them out of the process.
9. Alarm systems for fire, etc. will benefit most people if they incorporate both audible and visual elements. The hearing impaired and deaf students would be best alerted by flashing light alarms.
10. Emergency back-up lighting systems, especially in stairwells and other dark areas would benefit those students with limited visual acuity.
11. Students with hypertension, dyslexia or learning disabilities will have difficulty reading complicated directions for evacuation or response plans. Simple diagrams or pictures will give non-reading or overstressed students sufficient information to get to safety.
12. Hearing impaired students should practice some basic hand signals with the teachers and other students for emergency communication.

OAKLAND UNIFIED SCHOOL DISTRICT
Safety for Special Needs Populations

13. Mobility impaired students should practice moving their wheel chairs into designated safe areas, locking their wheels and covering their heads with a book or with their arms or hands.
14. Partnerships should be established between the able bodied and special needs students. The able bodied partners should be prepared (and practice during drills) to assist the special need student.
15. Rescue teams should be made aware of the best way to rescue special needs students. As an example, mobility impaired students should be allowed to instruct rescue team members on the best way to move them from the hazardous area. The fireman's carry may be dangerous to someone with respiratory problems.
16. Special response provisions may have to be made for ensuring duck and cover protection for these students. Barriers to earthquake safety are highly individual for them and accommodation plans may have to fit the requirements. The guidance provided by this document should be modified to fit each special situation of each special needs student. NOTE: ANY SPECIAL RESPONSE PROCEDURE MUST BE TESTED DURING EARTHQUAKE DRILLS.
17. Visually impaired or blind students should have an extra cane at school even if they have a Seeing Eye dog. They should be informed of alternate evacuation routes.

During the Earthquake

Special needs students or able bodied partners should implement special duck and cover actions. An example; mobility impaired students should know how (through practice) lock wheel chair wheels and cover head with book, arms or hands.

After the Earthquake

1. Hearing impaired or deaf students need face to face contact in order to read lips. Writing on a note pad is only practical if there is enough light to see.
2. During evacuation from classroom, sight impaired or blind students need to be informed about obstacles that may be in their paths and require verbal or physical guidance through hazardous areas.
3. In total darkness, sight impaired or blind students may be more capable of guiding sighted students and staff.
4. For mobility impaired students, evacuation by themselves may be extremely difficult or impossible because of obstacles in their paths or because electric dependant machines are not functioning (i.e., elevator). Special preplanned assistance must be provided.
5. Any special medications, supplies and equipment for the special needs students must be transported with them during evacuation.
6. If evacuation from school area is called for, utilize special transportation arrangements.
7. Re-establish special power requirements for the equipment of special needs students as soon as possible.

OAKLAND UNIFIED SCHOOL DISTRICT
Safety for Special Needs Populations

Rescue of special needs students should be accomplished utilizing special techniques as practiced.

Training for Rescue Service During an Emergency

1. Train personnel to regard a disabled person as the best expert in his or her disability and to ask a disabled person for advice before lifting or moving that person.
2. Train personnel to take extra time when communicating with people who are deaf, hearing impaired, or speech impaired.
3. Train personnel to never separate a disabled person from his or her assistive aids: wheelchairs, canes, hearing aids, medications, special diet food, urinary supplies, etc. Also, a service animal, usually a dog, is an assistive aid used by some blind, deaf and mobility impaired people.
4. Train personnel to realize that a disabled person's equipment may not be working after a disaster occurs, or it may be insufficient for emergency circumstances.
5. Train personnel to realize that a disaster may temporarily confuse service animals and they may not be able to help their owners as effectively as before the disaster.
6. Train rescue workers to know that some individuals with emotional and developmental disabilities may be too unsettled to respond appropriately to instructions and directions, such as a public address announcement to evacuate a building. Some disabled individuals may need to be in a quiet place for a while to regain their composure; others may even try to hide from rescue workers.
7. Train personnel to realize that some individuals with significant mental or learning disabilities might not understand the significance of "Keep Out" signs and barricade tape.

Evacuating Wheelchair Users

All Wheelchair Users

1. Discuss with the user of the wheelchair how to lift the user and the wheelchair either together or separately. When circumstances necessitate separating the user and the wheelchair, keep the period of separation to a minimum.
2. Some parts of a wheelchair are safe to lift from, others will come off when lifted. Always ask the user to confirm where it is safe to lift. Also, ask the user what else about his or her wheelchair you should know in order to lift it safely.
3. Wheelchairs with four wheels (not three-wheeled scooters) usually have handbrakes on each side of the chair. When the wheelchair is to remain stationary, set both brakes.
4. When more than one flight of stairs is traversed, helpers may need to switch positions since one person may be doing most of the lifting. Switch positions only on a level landing.

OAKLAND UNIFIED SCHOOL DISTRICT
Safety for Special Needs Populations

5. When the lifting is complete, follow the instructions of the chair's user and restore the manual or motorized wheelchair to full operation; then direct the user to a safe area.

Manual (non-motorized) Wheelchairs

1. Manual chairs weigh between 20 and 60 pounds. Two people are required to lift a manual wheelchair when occupied by the user.
2. Generally, the best way to lift the chair and user together is to position one helper behind the chair and the other helper in front. The helper behind the wheelchair tips it backwards to a balance angle that is tolerable to the user. The other helper grasps the front of the wheelchair and guides its movement. The two helpers lower or raise the wheelchair one step at a time, making sure both rear tires hit step edges evenly.

Motorized Wheelchairs

1. Motorized wheelchairs can weigh up to 100 pounds (un-occupied), and may be longer and heavier to push than manual wheelchairs. Some motorized chairs have additional electrical equipment such as a respirator or a communications device.
2. Lifting a motorized chair and user up or down stairs requires two to four helpers. Before lifting, discuss with the user if some heavy parts of the chair can be detached temporarily, how to position the helpers, where they should grab hold, and at what if any angle to tip the chair backward. Turn the chair's power off before lifting the chair.
3. If the chair's power drive is temporarily detached, the chair becomes "free wheeling". Helpers must realize they are entirely responsible for the safety of the user since the user of a motorized wheelchair generally lacks the arm function to control the chair's movement.

School Safety Plan Recommendations and Assurances

School Site Name: Martin Luther King, Jr. Elementary Site Number 182

The School Site Council (SSC) recommends this comprehensive School Site Safety Plan to the district governing board for approval, and assures the board of the following:

1. The School Site Council is correctly constituted, and was formed in accordance with district governing board policy and state law, per Education Code 52012. Under California Education Code 32281, the School Site Council or its delegates formed a School Site Safety committee with the minimum of the following members:
 - The Principal or designee
 - One teacher who is a representative of the recognized certificated employee organization
 - One parent whose child attends the school
 - One classified employee who is a representative of the recognized classified employee organization
 - Other members, if desired
2. The school plan and safety plan is based upon a thorough analysis of student safety goals/data. The actions and strategies proposed herein form a sound, comprehensive, and coordinated plan to reach stated safety goals and to meet all safety planning procedures.
3. The School Site Council reviewed the content requirements of the Site Safety Plan and assures all requirements have been met.
4. The safety plan was communicated to the public, per Education Code section 35294.2 (e): "...an updated file of all safety related plans and materials shall be readily available for inspection by the public."
5. Opportunity was provided for this school's Safety Plan (per Education Codes Sections 35294.8(b), 35294.2(e), and 32288) for public input and adopted by the School Site Council at a public meeting (s) on: Dec. 19, 2014; Dec. 8, 2014

In your Site Safety Plan, include documentation of how you provided an opportunity for public review and how the public can access or review the plan

The public was alerted about the meeting through one of the following:

- Fliers in students' home languages (date) Dec. 15, 2014
- Announcement at the public meeting (date) December 19, .; Dec. 8,
- Other - _____ (date) _____
Please specify the type of notice/media announcements

Signatures

<u>Roma Groves</u> Print name of school principal	<u>Roma Groves</u> Signature	<u>12/19/14</u> Date
<u>Soni Hamilton</u> Print name of SSC chairperson	<u>Soni Hamilton</u> Signature	<u>12/19/14</u> Date
<u>Kyla R Johnson-Tanner</u> Print name of Network Superintendent	<u>[Signature]</u> Signature	<u>12-19-14</u> Date