

Board Office Use: Legislative File Info.	
File ID Number	20 -1317
Introduction Date	6-24-2020
Enactment Number	20-1059
Enactment Date	6/24/2020 er



OAKLAND UNIFIED
SCHOOL DISTRICT
Community Schools, Thriving Students

Memo (Bid Award)

To Board of Education

From Kyla Johnson-Trammell, Superintendent
Tadashi Nakadegawa, Interim Deputy Chief, Facilities Planning & Management Department

Board Meeting Date June 24, 2020

Subject Award of General Services Agreement for Furniture Purchase - Competitively Bid - Fremont High School Increments 3 & 4 Furniture Project - Metro Contract Group- Facilities Planning & Management

Action Requested Approval by the Board of Education of Award of General Services Agreement for Furniture Purchase - Competitively bid - on behalf of the District to Metro Contract Goup (“Consultant”), Oakland, California, for the latter provide delivery and furnish furniture for the new Fremont High School Building B and Gymnasium including Fitness Room. A Total of 35 classrooms which include the gym and flex space that need to be furnished, there is no existing furniture for the building. Furniture include science classrooms, skilled trade’s fab lab, digital media, video control, audio control and recording studio, for the Fremont High School Increments 3 & 4 Furniture Project, in the amount of \$623,807.00, which includes a contingency of \$20,000.00, as the lowest responsive and responsible bidder, and rejecting all other bids if any, and authorizing the President and Secretary of the Board to sign the Agreement for same with said bidder. The contract shall commence on **June 25, 2020** and contractor shall complete the services within one hundred twenty (120) days, for a planned completion date of **October 23, 2020**.

Discussion The scope of work of the contract consists of purchase, delivery, and furnishing of furniture. Consultant was selected through competitive bidding. (Public Contract Code 20112).

LBP (Local Business Participation Percentage) 00.00%

Recommendation Approval by the Board of Education of Award of General Services Agreement for Furniture Purchase - Competitively bid - on behalf of the District to Metro Contract Goup (“Consultant”), Oakland, California, for the latter provide delivery and furnish furniture for the new Fremont High School Building B and Gymnasium including Fitness Room. A Total of 35 classrooms which include the gym and flex space that need to be furnished, there is no existing furniture for the building. Furniture include science classrooms, skilled trade’s fab lab, digital media, video control, audio control and recording studio, for the Fremont High School Increments 3 & 4 Furniture Project, in the amount of \$623,807.00, which includes a contingency of \$20,000.00, as the lowest responsive and responsible bidder, and rejecting all other bids if any, and authorizing the President and Secretary of the Board to sign the Agreement for same with said bidder. The contract shall commence on June 25, 2020 and

contractor shall complete the services within one hundred twenty (120) days, for a planned completion date of October 23, 2020.

Fiscal Impact

Fund 21, Measure J

Attachments

- Agreement
- Insurance Certificate



CONTRACT JUSTIFICATION FORM
**This Form Shall Be Submitted to the Board Office With Every
Agenda Contract.**

Legislative File ID No. _____

Department: Facilities Planning & Management

Vendor Name: Metro Contract Group

Project Name: Fremont HS Increments 3 & 4 Furniture **Project No.:** 13158

Contract Term: Intended Start: June 25, 2020 Intended End: 10-23-2020

Total Cost Over Contract Term: \$623,807.19

Approved by: Tadashi Nakadegawa

Is Vendor a local Oakland Business or has it met the requirements of the

Local Business Policy? Yes (No if Unchecked)

How was this contractor or vendor selected?

Metro Contract Group, was selected by the District as the lowest responsive and responsible bid.

Summarize the services or supplies this contractor or vendor will be providing.

To provide furniture for the new Fremont High School Building B and Gymnasium including Fitness Room. A Total of 35 classrooms which include the gym and flex space that need to be furnished, there is no existing furniture for the building. Furniture include science classrooms, skilled trade’s fab lab, digital media, video control, audio control and recording studio.

Was this contract competitively bid? Check box for “Yes” (If “No,” leave box unchecked)

If “No,” please answer the following questions:

- 1) How did you determine the price is competitive?

2) Please check the competitive bidding exception relied upon:

Construction Contract:

- Price is at or under UPCCAA threshold of \$60,000 (as of 1/1/19)
- CMAS contract [may only include “incidental work or service”] (Public Contract Code §§10101(a) and 10298(a)) – *contact legal counsel to discuss if applicable*
- Emergency contract (Public Contract Code §§22035 and 22050) – *contact legal counsel to discuss if applicable*
- No advantage to bidding – *contact legal counsel to discuss if applicable*
- Sole source contractor – *contact legal counsel to discuss if applicable*
- Completion contract – *contact legal counsel to discuss if applicable*
- Lease-leaseback contract RFP process – *contact legal counsel to discuss if applicable*
- Design-build contract RFP process – *contact legal counsel to discuss if applicable*
- Energy service contract – *contact legal counsel to discuss if applicable*
- Other: _____ – *contact legal counsel to discuss if applicable*

Consultant Contract:

- Construction project manager, land surveyor, or environmental services – selected based on demonstrated competence and professional qualifications (Government Code §4526)
- Architect or engineer – use of a fair, competitive RFP selection process (Government Code §§4529.10 et seq.)
- Architect or engineer when state funds being used – use of competitive process consistent with Government Code §§4526-4528 (Education Code §17070.50)
- Other professional or specially trained services or advice – no bidding or RFP required (Public Contract Code §20111(d) and Government Code §53060) – *contact legal counsel to discuss if applicable*
- For services other than above, the cost of services is \$95,200 or less (as of 1/1/20)
- No advantage to bidding (including sole source) – *contact legal counsel to discuss if applicable*

Purchasing Contract:

- Price is at or under bid threshold of \$95,200 (as of 1/1/20)
- Certain instructional materials (Public Contract Code §20118.3)
- Data processing systems and supporting software – choose one of three lowest bidders (Public Contract Code §20118.1)

- Electronic equipment – competitive negotiation (Public Contract Code §20118.2) – *contact legal counsel to discuss if applicable*
- CMAS contract [may only include “incidental work or service”] (Public Contract Code §§10101(a) and 10298(a)) – *contact legal counsel to discuss if applicable*
- Piggyback contract for purchase of personal property (Public Contract Code §20118) – *contact legal counsel to discuss if applicable*
- Supplies for emergency construction contract (Public Contract Code §§22035 and 22050) – *contact legal counsel to discuss if applicable*
- No advantage to bidding (including sole source) – *contact legal counsel to discuss if applicable*
- Other: RFP for FF&E selection was made out of proposals from pool.

Maintenance Contract:

- Price is at or under bid threshold of \$95,200 (as of 1/1/20)
- No advantage to bidding (including sole source) – *contact legal counsel to discuss*
- Other: _____

3) Explain in detail the facts that support the applicability of the exception marked above:

**OAKLAND UNIFIED SCHOOL DISTRICT
GENERAL SERVICES AGREEMENT**

This GENERAL SERVICES AGREEMENT (“Agreement”) is made and entered into effective **June 25, 2020** (the “Effective Date”), by and between the Oakland Unified School District (“District”) and **Metro Contract Group** (“Contractor”).

1. **Contractor Services.** Contractor agrees to provide the following services to District (collectively, the “Services”): Metro Contract Group, to provide furniture for the new Fremont High School Building B and Gymnasium including Fitness Room. A Total of 35 classrooms which include the gym and flex space that need to be furnished, there is no existing furniture for the building. Furniture include science classrooms, skilled trade’s fab lab, digital media, video control, audio control and recording studio, as fully described in the bid package for the Agreement and bid documents (including the Bid Form) submitted by Contractor, with all such documents being incorporated by reference into this agreement. The Services include all work described in the Notice to Bidders and the Fremont High School Building B Furniture Specification Package Addendum #2, dated May 28, 2020, which are attached to this Agreement as Exhibit A.
2. **Contractor Qualifications.** Contractor represents and warrants to District that Contractor, and all of Contractor’s employees, agents or volunteers (the “Contractor Parties”), have in effect and shall maintain in full force throughout the Term of this Agreement all licenses, credentials, permits and any other qualifications required by law to perform the Services and to fully and faithfully satisfy all of the terms set forth in this Agreement. Contractor and any Contractor Parties performing services shall be competent to perform those services.
3. **Term.** This Agreement shall begin on **June 25, 2020** and shall terminate upon completion of the Services, but no later than **October 23, 2020** (“Term”), except as otherwise stated in **Paragraph 4** below. There shall be no extension of the Term of this Agreement without the express written consent of all parties. Written notice by the District Superintendent or designee shall be sufficient to stop further performance of the Services by Contractor or the Contractor Parties. In the event of early termination, Contractor shall be paid for satisfactory Services performed to and including the date of termination. Upon payment by District, District shall be under no further obligation to Contractor, monetarily or otherwise, and District may proceed with the work in any manner District deems proper.
4. **Termination.** This Agreement shall begin on June 25, 2020, Contractor shall commence performance of the Services on that date, and Contractor shall complete the Services within one hundred twenty (120) calendar days of that date. Notwithstanding the foregoing, District may terminate this Agreement at any time by giving written notice to Contractor if Contractor materially breaches any of the terms of this Agreement, any act or omission of Contractor or the Contractor Parties exposes District to potential liability or may cause an increase in District’s insurance premiums, Contractor is adjudged a bankrupt, Contractor makes a general assignment for the benefit of creditors or a receiver is appointed because of Contractor’s insolvency. Such termination shall be effective immediately upon Contractor’s receipt of the notice.
5. **Payment of Fees for Services.** Total fees paid by District to Contractor for Services under the Agreement shall be **SIX HUNDRED TWENTY-THREE THOUSAND EIGHT HUNDRED SEVEN DOLLARS AND NINETEEN CENTS (\$623,807.19), which includes a contingency of \$20,000.00).** Contractor shall perform all Services required by the Agreement even if the Fee has already been paid

and no more payments will be forthcoming. District agrees to pay the Fee, within Thirty (30) days of receipt of a detailed invoice from Contractor, including any additional supporting documentation District reasonably requests.

6. **Indemnity.** Contractor shall, indemnify, and hold harmless District and its agents, representatives, officers, consultants, employees, Board of Trustees, members of the Board of Trustees (collectively, the “District Parties”), from and against any and all claims, demands, liabilities, damages, losses, suits and actions, and expenses (including, but not limited to attorney fees and costs including fees of consultants) (collectively, the “Claims”) to the extent directly arising out of, or resulting from any act, error, omission, negligence, or willful misconduct of Contractor, the Contractor Parties or their respective agents, subcontractors, employees, material or equipment suppliers, invitees, or licensees in the performance of or failure to perform Contractor’s obligations under this Agreement, including, but not limited to Contractor’s or the Contractor Parties’ use of the site, Contractor’s or the Contractor Parties’ performance of the Services, Contractor’s or the Contractor Parties’ breach of any of the representations or warranties contained in this Agreement, or for injury to or death of persons or damage to property or delay or damage to the District or the District Parties. Such obligation shall not be construed to negate, abridge, or reduce other rights or obligations of indemnity, which would otherwise exist as to a party, person, or entity described in this paragraph.

7. **Equipment and Materials.** Contractor at its sole cost and expense shall provide and furnish all tools, labor, materials, equipment, transportation services and any other items (collectively, “Equipment”) which are required or necessary to perform the Services in a manner which is consistent with generally accepted standards of the profession for similar services. Notwithstanding the foregoing, District shall not be responsible for any damages to persons or property as a result of the use, misuse or failure of any Equipment used by Contractor or the Contractor Parties, even if such Equipment is furnished, rented or loaned to Contractor or the Contractor Parties by District. Furthermore, District may reject any Equipment or workmanship that does not conform to the requirements of this Agreement and Contractor must then promptly remedy or replace it at no additional cost to District and subject to District’s reasonable satisfaction.

8. **Insurance.** Contractor shall secure and maintain throughout the Term of this Agreement the following insurance: (i) comprehensive general liability insurance with limits of not less than **\$ 1,000,000** each occurrence and **\$2,000,000** in the aggregate; (ii) commercial automobile liability insurance with limits not less than **\$1,000,000** each occurrence and **\$2,000,000** in the aggregate, if applicable; and (iii) worker’s compensation insurance as required by Labor Code section 3200, *et seq.*, if applicable. Neither Contractor nor any of the Contractor Parties shall commence performing any portion of the Services until all required insurance has been obtained and certificates indicating the required coverages have been delivered to and approved by District. All insurance policies shall include an endorsement stating that District and District Parties are named additional insureds. All of the policies shall be amended to provide that the insurance shall not be suspended, voided, canceled except after thirty (30) days’ prior written notice has been given to District. If such a notice is not given or even if District receives a notice, District may, at its sole option, terminate this Agreement. All insurance policies shall include an endorsement stating that it is primary to any insurance or self-insurance maintained by District and shall waive all rights of subrogation against District and/or the District Parties. A copy of the Contractor’s insurance certificate shall be attached to this Agreement as proof of insurance.

9. **Independent Contractor Status.** Contractor is engaged in an independently established trade, occupation, or business to provide the Services required by this Agreement and is hereby retained to provide specialized services for District that are outside the usual course of District's business. Contractor is free from the control and direction of District in connection with the manner in which it provides the Services to District. Contractor understands and agrees that Contractor and the Contractor Parties shall not be considered officers, employees, agents, partners, or joint venturers of District, and are not entitled to benefits of any kind or nature normally provided to employees of District and/or to which District's employees are normally entitled.

10. **Taxes.** All payments made by District to Contractor pursuant to this Agreement shall be reported to the applicable federal and state taxing authorities as required. District will not withhold any money from fees payable to Contractor, including FICA (social security), state or federal unemployment insurance contributions, or state or federal income tax or disability insurance. Contractor shall assume full responsibility for payment of all federal, state and local taxes or contributions, including unemployment insurance, social security and income taxes with respect to Contractor and the Contractor Parties and otherwise in connection with this Agreement.

~~11. **Fingerprinting/Criminal Background Investigation Certification.** Contractor and the Contractor Parties shall at all times comply with the fingerprinting and criminal background investigation requirements of the California Education Code ("Education Code") section 45125.1, and shall complete the Fingerprinting Notice and Acknowledgement Form and Student Contract Form.~~

12. **Tuberculosis Certification.** Contractor and the Contractor Parties shall at all times comply with the tuberculosis ("TB") certification requirements of Education Code section 49406. Accordingly, by checking the applicable boxes below, Contractor hereby represents and warrants to District the following:

A. Contractor and Contractor Parties shall **only have limited or no contact** (as determined by District) with District students at all times during the Term of this Agreement.

B. The following Contractor and Contractor Parties shall have **more than limited contact** (as determined by District) with District students during the Term of this Agreement and, at no cost to District, have received a TB test in full compliance with the requirements of Education Code section 49406:

_____. [Attach and sign additional pages, as needed.]

Contractor shall maintain on file the certificates showing that the Contractor and Contractor Parties were examined and found free from active TB. These forms shall be regularly maintained and updated by Contractor and shall be available to District upon request or audit.

Contractor further agrees and acknowledges that all new personnel hired after the Effective Date of this Agreement by Contractor and Contractor Parties are subject to the TB certification requirements and shall be prohibited from having any contact with District students until the TB certification requirements have been satisfied and District determines whether any contact is

permissible.

13. **Confidential Information.** Contractor shall maintain the confidentiality of, and protect from unauthorized disclosure, any and all individual student information received from the District, including but not limited to student names and other identifying information. Contractor shall not use such student information for any purpose other than carrying out the obligations under this Agreement. Upon request from the District, Contractor shall turn over to District all educational records related to the services provided to any District student pursuant to this Agreement.

14. **Assignment/Successors and Assigns.** Contractor shall not assign or transfer by operation of law or otherwise any or all of its rights, burdens, duties or obligations under this Agreement without the prior written consent of District. Subject to the foregoing, this Agreement shall be binding on the heirs, executors, administrators, successors, and assigns of the respective parties.

15. **Severability.** If any provision of this Agreement shall be held invalid or unenforceable by a court of competent jurisdiction, such holding shall not invalidate or render unenforceable any other provision of this Agreement.

16. **Amendments.** The terms of this Agreement shall not be waived, altered, modified, supplemented or amended in any manner whatsoever except by written agreement signed by both parties and approved by the governing board.

17. **Governing Law.** This Agreement shall be governed by and construed in accordance with the laws of the State of California, excluding its choice of law rules. Any action or proceeding seeking any relief under or with respect to this Agreement shall be brought solely in the Superior Court of the State of California for the County of Alameda, subject to transfer of venue under applicable State law, provided that nothing in this Agreement shall constitute a waiver of immunity to suit by the District.

18. **Written Notice.** Written notice shall be deemed to have been duly served if delivered in person to the address located next to the party signatures below, or if delivered at or sent by registered or certified or overnight mail to the last business address known to the person who sends the notice.

19. **Compliance with Law.** Each and every provision of law and clause required by law to be inserted into this Agreement shall be deemed to be inserted herein and this Agreement shall be read and enforced as though it were included therein. Contractor shall comply with all applicable federal, state, and local laws, rules, regulations and ordinances, including but not limited to fingerprinting under Education Code section 45125.1, confidentiality of records, Education Code section 49406 and others. Contractor agrees that it shall comply with all legal requirements for the performance of duties under this Agreement and that failure to do so shall constitute material breach.

20. **Non-Discrimination.** There shall be no unlawful discrimination in the contracting of persons under this Agreement because of race, color, national origin, age, ancestry, religion, sex, or sexual orientation of such persons.

21. **Attorneys' Fees.** If any legal action is taken to interpret or enforce the terms of this Agreement, the prevailing party shall be entitled to recover reasonable attorneys' fees and other reasonable costs and

expenses incurred in connection with that legal action.

22. **Liability of the Parties.** Notwithstanding anything stated herein to the contrary, neither party shall be liable for any special, consequential, indirect or incidental damages, including but not limited to lost profits in connection with this Agreement.

23. **Time.** Time is of the essence to this Agreement.

24. **Waiver.** No delay or omission by District in exercising any right under this Agreement shall operate as a waiver of that or any other right and no single or partial exercise of any right shall preclude the District from any or further exercise of any right or remedy.

25. **Entire Agreement.** This Agreement is intended by the parties as the final expression of their agreement with respect to such terms as are included herein and as the complete and exclusive statement of its terms and may not be contradicted by evidence of any prior agreement or of a contemporaneous oral agreement, nor explained or supplemented by evidence of consistent additional terms.

26. **Ambiguity.** The parties to this Agreement, and each of them, hereby represent that the language contained herein is to be construed as jointly proposed and jointly accepted, and in the event of any subsequent determination of ambiguity, all parties shall be treated as equally responsible for such ambiguity.

27. **Execution of Other Documents.** The parties to this Agreement shall cooperate fully in the execution of any and all other documents and in the completion of any additional actions that may be necessary or appropriate to give full force and effect to the terms and intent of this Agreement.

28. **Execution in Counterparts.** This Agreement may be executed in counterparts such that the signatures may appear on separate signature pages. A copy, facsimile, or an original, with all signatures appended together, shall be deemed a fully executed agreement.

29. **Warranty of Authority.** The persons who have signed this Agreement warrant that they are legally authorized to do so on behalf of the respective parties, and by their signatures to bind the respective parties to this Agreement.

~~30. **Local Business.** Contractor shall comply with the requirements of the District's Local, Small Local, and Small Local Resident Business Enterprise Program, which may require a 50% minimum local participation requirement in the performance of this Agreement. A copy of this program may be obtained at www.ousd.k12.ca.us, under the Facilities Planning & Management Department drop down menu, at "Bids and Requests for Proposals."~~

31. **Forms.** The following forms, attached to the contract, are incorporated into the contract:

- ~~• Roof project certification (if required; see Public Contract Code §3006).~~
- Fingerprinting Notice and Acknowledgement.
- ~~• Iran Contracting Act Certification.~~
- Workers' Compensation Certification.
- Drug-Free Workplace Certification.

- ~~Buy American Certification.~~
- ~~Local Business Participation Form.~~

Within ten (10) days after award and before commencement of the services, the signed agreement, insurance documentation, and Student Contract Form (see Exhibit B to the Fingerprinting Notice and Acknowledgement) shall be submitted to the District.

32. **Mediation.** A party to this Agreement shall, as a condition precedent to initiating any litigation against the other party, demand mediation of any dispute. The parties shall endeavor to include any third party claimant in the mediation. The parties shall select a mediator and schedule the mediation within thirty (30) days of the initial demand for mediation. If the parties cannot agree on a mediator, the mediator shall be appointed by JAMS. The parties to the mediation, including the parties to this Agreement, shall pay equal shares of the mediator’s fees. Each party shall bear its own attorney’s fees related to the mediation.

DISTRICT:

OAKLAND UNIFIED SCHOOL DISTRICT

 6/25/2020

 Jody London, Date
 President, Board of Education

 6/25/2020

 Kyla Johnson-Trammell, Date
 Superintendent, Board of Education

 6/8/20

 Tadashi Nakadegawa, Date
 Interim, Deputy Chief, Facilities Planning & Management

Approved As to Form:

 6/8/2020

 OUSD Facilities Legal Counsel Date

CONTRACTOR:

Metro Contract Group-

By: 

Name: Dwight Jackson

Title: President

Exhibit A



EXHIBIT A

**Fremont High School
Building B
Furniture Specification Package**

Prepared by: Quattrocchi Kwok Architects
For
Oakland Unified School District



Addendum #2 May 28, 2020



Table of Contents

- 1 Level 1 Room Identification
- 1 Level 2 Room Identification
- 1 Gym – Room Identification
- 2 Furniture Code
- 3 Furniture Spec Sheets – Seating
- 3 Furniture Spec Sheets – Desks/Tables
- 3 Furniture Spec Sheets – Storage/Accessories
- 3 Furniture Spec Sheets – Gym
- 4 **Rooms:**
 - 1. Classroom Typ.
 - 2. Science Classroom Typ.
 - 3. Engineering & Design
 - 4. Skilled Trades Fab Lab
 - 5. Office/Intervention Room
 - 6. Science Classroom
 - 7. Public Services Typ.
 - 8. Small Group Room Typ.
 - 9. CTE Classroom
 - 10. Digital Media A
 - 11. Recording Studio
 - 12. Digital Media B
 - 13. Work Room and Custodial Typ.
- 5 **Gym**
 - 1. Fitness Room
 - 2. Office Typ.
 - 3. Custodial

Fremont High School Furniture Package- Bldg. B



OAKLAND UNIFIED SCHOOL DISTRICT
Community Schools, Thriving Students

1 Room ID – Level 1

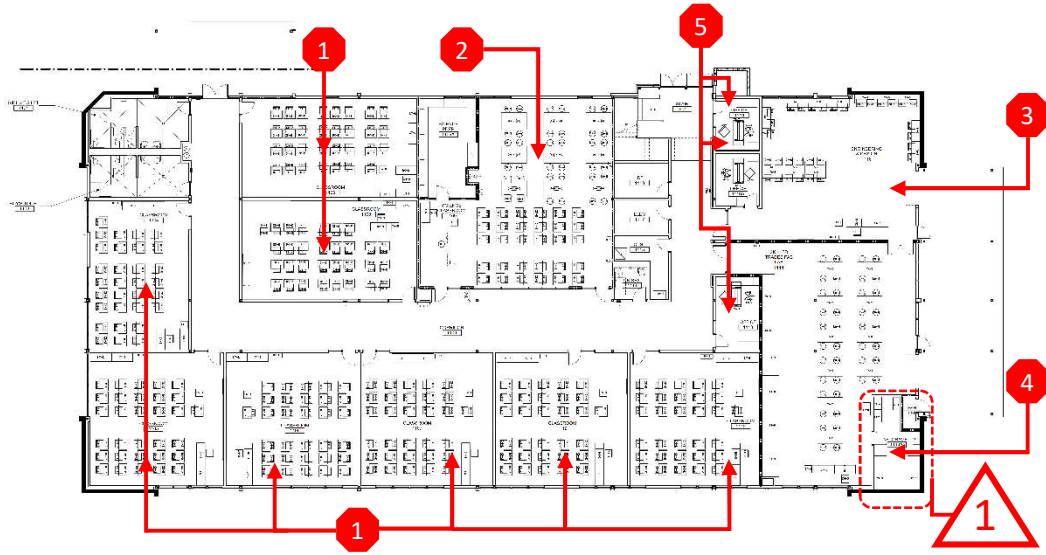

1 FURNITURE PLAN - LEVEL 1

FLOOR PLAN NOTES

1. REFER TO THE GENERAL NOTES FOR ALL NOTES.
2. ALL DIMENSIONS ARE TO FACE UNLESS NOTED OTHERWISE.
3. REFER TO THE GENERAL NOTES FOR ALL NOTES.
4. REFER TO THE GENERAL NOTES FOR ALL NOTES.
5. REFER TO THE GENERAL NOTES FOR ALL NOTES.
6. REFER TO THE GENERAL NOTES FOR ALL NOTES.
7. REFER TO THE GENERAL NOTES FOR ALL NOTES.
8. REFER TO THE GENERAL NOTES FOR ALL NOTES.
9. REFER TO THE GENERAL NOTES FOR ALL NOTES.
10. REFER TO THE GENERAL NOTES FOR ALL NOTES.
11. REFER TO THE GENERAL NOTES FOR ALL NOTES.
12. REFER TO THE GENERAL NOTES FOR ALL NOTES.
13. REFER TO THE GENERAL NOTES FOR ALL NOTES.
14. REFER TO THE GENERAL NOTES FOR ALL NOTES.
15. REFER TO THE GENERAL NOTES FOR ALL NOTES.
16. REFER TO THE GENERAL NOTES FOR ALL NOTES.
17. REFER TO THE GENERAL NOTES FOR ALL NOTES.
18. REFER TO THE GENERAL NOTES FOR ALL NOTES.
19. REFER TO THE GENERAL NOTES FOR ALL NOTES.
20. REFER TO THE GENERAL NOTES FOR ALL NOTES.
21. REFER TO THE GENERAL NOTES FOR ALL NOTES.
22. REFER TO THE GENERAL NOTES FOR ALL NOTES.
23. REFER TO THE GENERAL NOTES FOR ALL NOTES.
24. REFER TO THE GENERAL NOTES FOR ALL NOTES.
25. REFER TO THE GENERAL NOTES FOR ALL NOTES.
26. REFER TO THE GENERAL NOTES FOR ALL NOTES.
27. REFER TO THE GENERAL NOTES FOR ALL NOTES.
28. REFER TO THE GENERAL NOTES FOR ALL NOTES.
29. REFER TO THE GENERAL NOTES FOR ALL NOTES.
30. REFER TO THE GENERAL NOTES FOR ALL NOTES.
31. REFER TO THE GENERAL NOTES FOR ALL NOTES.
32. REFER TO THE GENERAL NOTES FOR ALL NOTES.
33. REFER TO THE GENERAL NOTES FOR ALL NOTES.
34. REFER TO THE GENERAL NOTES FOR ALL NOTES.
35. REFER TO THE GENERAL NOTES FOR ALL NOTES.
36. REFER TO THE GENERAL NOTES FOR ALL NOTES.
37. REFER TO THE GENERAL NOTES FOR ALL NOTES.
38. REFER TO THE GENERAL NOTES FOR ALL NOTES.
39. REFER TO THE GENERAL NOTES FOR ALL NOTES.
40. REFER TO THE GENERAL NOTES FOR ALL NOTES.
41. REFER TO THE GENERAL NOTES FOR ALL NOTES.
42. REFER TO THE GENERAL NOTES FOR ALL NOTES.
43. REFER TO THE GENERAL NOTES FOR ALL NOTES.
44. REFER TO THE GENERAL NOTES FOR ALL NOTES.
45. REFER TO THE GENERAL NOTES FOR ALL NOTES.
46. REFER TO THE GENERAL NOTES FOR ALL NOTES.
47. REFER TO THE GENERAL NOTES FOR ALL NOTES.
48. REFER TO THE GENERAL NOTES FOR ALL NOTES.
49. REFER TO THE GENERAL NOTES FOR ALL NOTES.
50. REFER TO THE GENERAL NOTES FOR ALL NOTES.

PROJECT INFORMATION
 PROJECT NAME: FREMONT HIGH SCHOOL - MODERNIZATION & NEW CONSTRUCTION - INCIDENT # 15
 DATE: 05/26/2020

SCALE: AS SHOWN
 DATE: 05/26/2020
 DRAWING NO.: F1.01

Room Type	Quantity	Notes
1 Classroom	8	
2 Science Classroom	1	
3 Engineering & Design	1	
4 Skilled Trades Fab Lab	1	
5 Office/Intervention Room	2	

Level 1
Scale: NTS

Fremont High School Furniture Package- Bldg. B



OAKLAND UNIFIED SCHOOL DISTRICT
Community Schools, Thriving Students

1 Room ID – Level 2

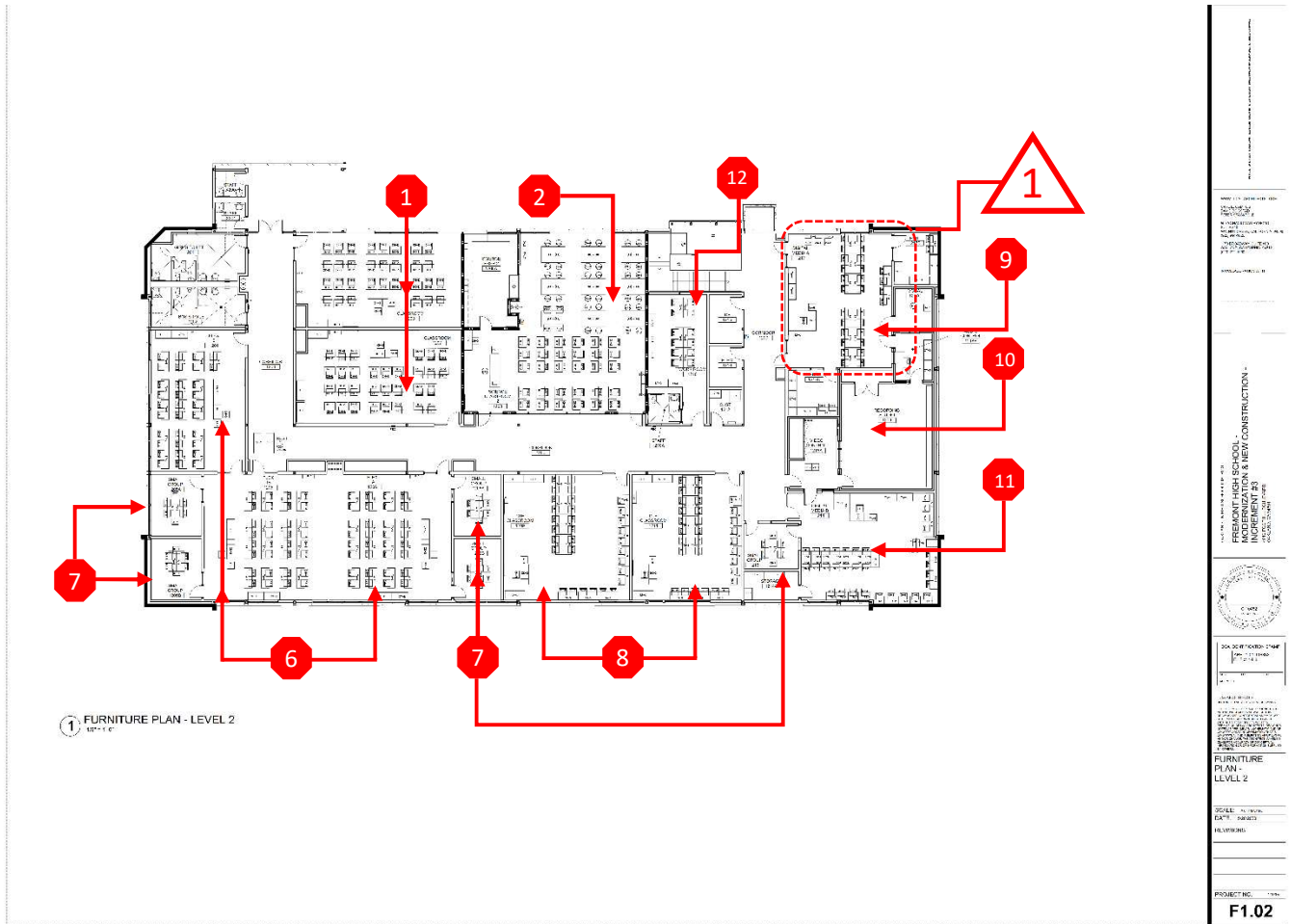

Room Type	Quantity	Notes
1 Classroom	2	
2 Science Classroom	1	
6 Public Services/Flex	3	
7 Small Group Room	5	
8 CTE Classroom	2	
9 Digital Media A	1	Contains (2)Edit/Vocal/Audio Rooms
10 Recording Studio	1	Contains Video Control
11 Digital Media B	1	Contains Storage Room
12 Work Room	1	

Level 2

Scale: NTS



May 26, 2020 Addendum

Fremont High School Furniture Package- Bldg. B



OAKLAND UNIFIED
SCHOOL DISTRICT
Community Schools, Thriving Students

1 Room ID – Gym

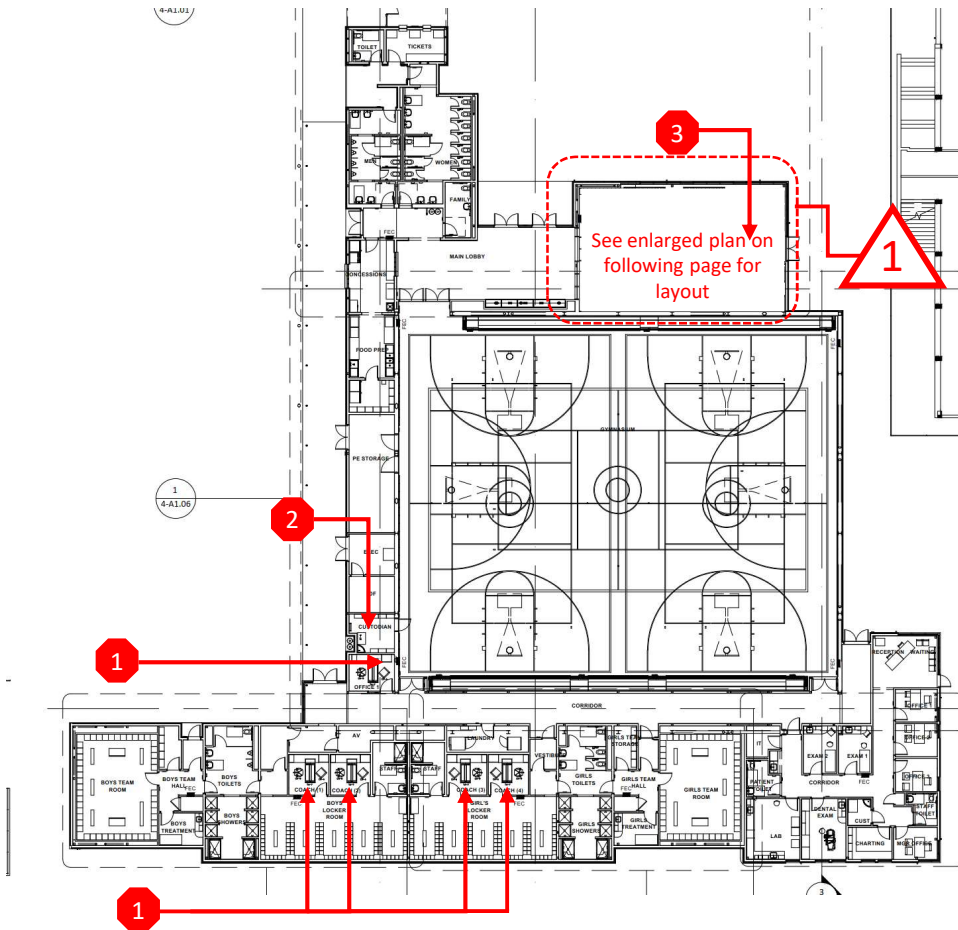

Room Type	Quantity	Notes
1 Office	5	
2 Janitor	1	
3 Fitness Room	1	

Gym

Scale: NTS



May 26, 2020 Addendum

Fremont High School Furniture Package- Bldg. B



OAKLAND UNIFIED SCHOOL DISTRICT
Community Schools, Thriving Students

1 Room ID – Gym

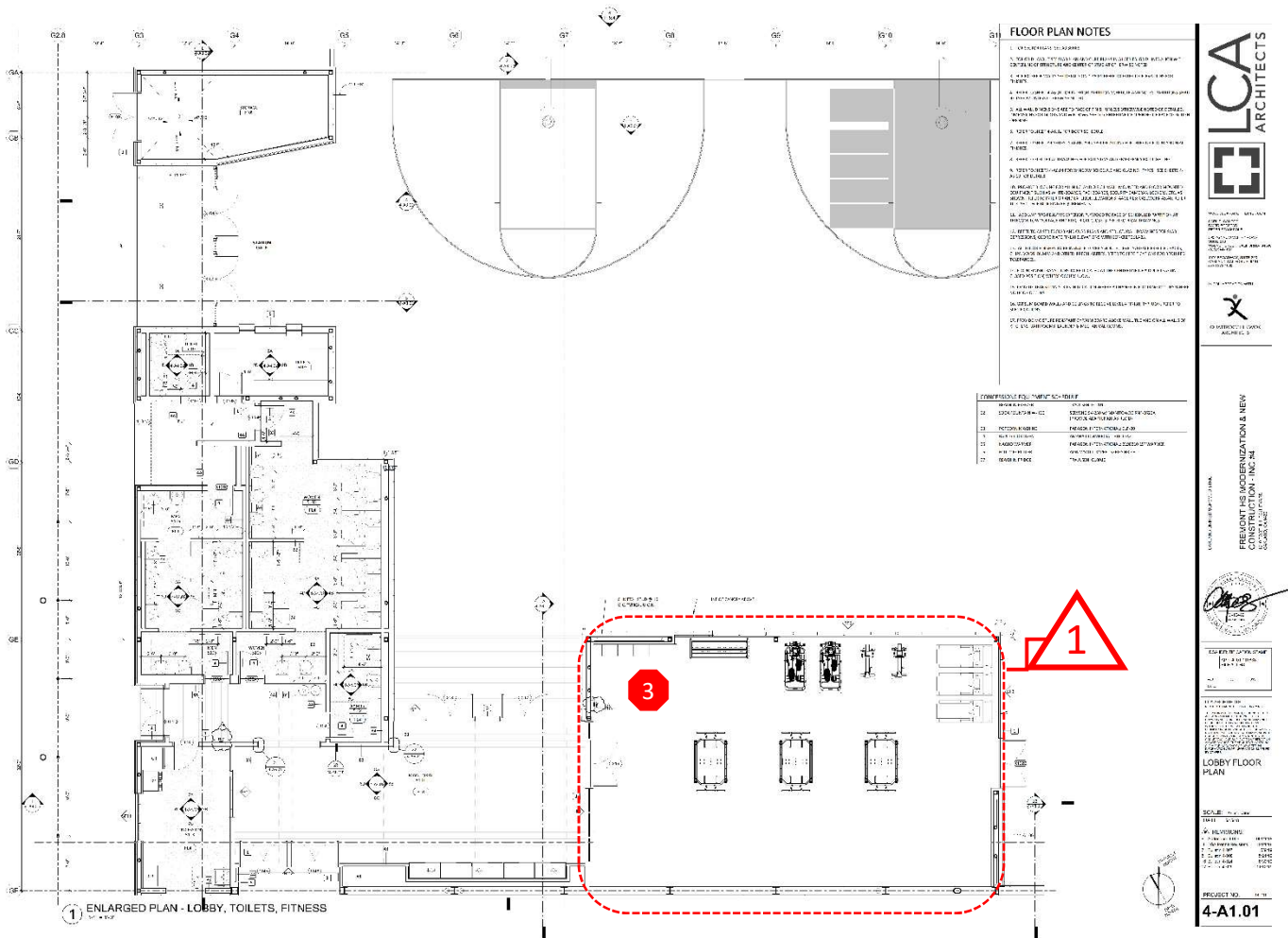

Room Type	Quantity	Notes
1 Office	5	
2 Janitor	1	
3 Fitness Room	1	

Fitness Enlarged

Scale: NTS

Fremont High School Furniture Package- Bldg. B



OAKLAND UNIFIED SCHOOL DISTRICT
Community Schools, Thriving Students

2 Furniture Code

1437.00 - FREMONT HIGH SCHOOL
FURNITURE PROGRAMMING : FURNITURE CODE



21-May-20

TYPE	CODE	New Product	ESTIMATED NET PRICE	QTY FIRST FLOOR	QTY SECOND FLOOR	Gym	TOTAL	NOTES
SEATING	CH-1	ScholarCraft					0	High Stool (Not Used-)
	CH-2	2thrive Chair - ScholarCraft	\$ -	251	252		503	classroom chair
	CH-3	510 2thrive Swivel Chair -ScholarCraft		10	18		28	Teacher Chair / Casters
	CH-4	3400 Series - ScholarCraft		3	138	5	146	OFFICE / Small Group?
	CH-5	Dolly for CH-4 - Teknion		0	2		2	Flex Rooms Stacking Chair Dolly
	CH-6	Diversified		32	32		64	CHEMISTRY LABS? No spinning, no wheels/ no backs metal
	CH-7	#6418H Grainger		36	0		36	SKILLED TRADE LABS
	CH-8	2thrive Stool - ScholarCraft		1	2		3	CHEMISTRY LABS TEACHER STOOL
	CH-9	T-3 Teknion		3	0	5	8	Office Task Chair
DESK/TABLE	DK-1	ScholarCraft					0	Not applicable - High Desk double - (Not Used-)
	DK-2	ScholarCraft		278	92		370	Single Desk
	DK-3	Method Desk - ScholarCraft		10	9		19	Teacher
	LN-1	Haskell		11	10		21	Classroom
	TA-1	Flip Desk ScholarCraft		0	42		42	SMALL GROUP / Flip / Double Desk 24"x60"
	TA-2	8700 Series ScholarCraft		0	27		27	Digital Media - 24"x36" / Adjustable Height / CPU? / Keyboard Tray
	TA-3	8700 Series ScholarCraft		15	51		66	Digital Media - 24"x60" Adjustable Height
	TA-4	Diversified Counter		0	7		7	Milwork Counters 24x48
STORAGE/CABINETS/MISC.	TA-5	Diversified / Grainger		9	0		9	SKILLED TRADE LABS / 36"x72"
	TA-6	Cover Occasional Table - Teknion		0	1		1	VOCAL
	TA-7	Private Office Teknion		3	0	5	8	
	TA-8	Podium		10	10		20	Haskell Podium
	ST-1	Deskmakers/Diversified(TBC)		9	7		16	Mobile Cubby
	ST-2	Haskell or eq.		9	6		15	SMALL GROUP/Classroom
	ST-3	Haskell or eq.		0	14		14	LOCKING CABINETS TALL
	BK-1	Haskell or eq.		11	8		19	SHIGH OPEN BOOKSHELVES MTL.
	RF-1	Owner Supplied-TBC		0	1		1	Refrigerator - TBD
	ST-4	#5JL48- Grainger		4	0		4	GRAINGER - SKILLED TRADES LAB 21"Dx36Wx82"H
	ST-5	Global Industrial #WGB2257484		4	0		4	Global Industrial - SKILLED TRADES LAB 96"W x 36"D x 84"H
ST-6	#A536C - Grainger		1	3	1	4	Storage Room 24X36X83 (1 @ gym in custodial)	
ST-7	A566C- Grainger		0	2		2	Storage Room 24X60X83	
ST-8	AP310S- Grainger		0	0		0	Video Control(Alt. Disale)(Not Used)	
ST-9	Grainger #S9LA60		2	0		2	GRAINGER - SKILLED TRADES LAB End Unit	
ST-10	Grainger 59LA57		2	0		2	GRAINGER - SKILLED TRADES LAB Full Unit	
ST-11	Grainger #1YNG2		1	0		1	GRAINGER - SKILLED TRADES LAB	
GYM EQUIPMENT	G-1	Pendulum Dual Rack Green Lower Yellow Uppers				3	3	
	G-2	7' Texas Power Bar				10	10	
	G-3	Pendulum Utility Bench Green				7	7	
	G-4	Pendulum Monster Incline Arms Green				4	4	
	G-5	Elliptical Cardio Machine				2	2	
	G-6	Pendulum Dumbbell Rack 89" 3 Tier				1	1	
	G-7	Pendulum 4Way Neck Machine Green lower Yellow Uppers				2	2	
	G-8	Pendulum Mono Post Dip Bar(Knurled) Attachment Color, Green				5	5	
	G-9	Pendulum Mono Post Dip Bar(Knurled) Attachment Color, Green				5	5	
	G-10	Pendulum Leg Curl Green lower Yellow uppers				2	2	
	G-11	Pendulum Leg Extension Green with yellow moving parts				2	2	
	G-12	Upright Bike				2	2	
	G-13	Tread Mill				3	3	
	G-14	1530lbs Rubber 8 Sided Rubber Hex Dumbbells				1	1	
	G-15	Pendulum Post Dip Bar Attachment Stage Black				4	4	

General Notes

1. Dealer is responsible for confirming final counts against drawings. Any discrepancies should be issued in a Request for Information to OUHSD.



May 26, 2020 Addendum

Fremont High School Furniture Package- Bldg. B



OAKLAND UNIFIED SCHOOL DISTRICT
Community Schools, Thriving Students

2 Furniture Code - Rooms

1437.00 - FREMONT HIGH SCHOOL
FURNITURE PROGRAMMING : ROOM CHART
21-May-20



ROOM NO.	ROOM NAME	CODE	CHAIR	TYPE	QTY	CODE	DESK/TABLE	TYPE	QTY	CODE	STORAGE/CABINETS/MISC.	TYPE	QTY	NOTES
FIRST FLOOR														
1101	GIRLS TOILET		N/A											
1102	BOYS TOILET		N/A											
1103	CLASSROOM	CH-2	2thrive Chair - ScholarCraft		31	DK-2	ScholarCraft		31	ST-1	Diversified / TBD		1	
		CH-3	510 2thrive Swivel Chair - ScholarCraft		1	DK-3	Method Desk - ScholarCraft		1	ST-2	Haskell or eq.		1	
		CH-3	510 2thrive Swivel Chair - ScholarCraft		1	LN-1	Haskell Fixed Teacher Desk		1	BK-1	Haskell or eq.		1	
		CH-3	510 2thrive Swivel Chair - ScholarCraft		1	TA-8	Haskell Podium		1					
1104	CLASSROOM	CH-2	2thrive Chair - ScholarCraft		31	DK-2	ScholarCraft		31	ST-1	Diversified / TBD		1	
		CH-3	510 2thrive Swivel Chair - ScholarCraft		1	DK-3	Method Desk - ScholarCraft		1	ST-2	Haskell or eq.		1	
		CH-3	510 2thrive Swivel Chair - ScholarCraft		1	LN-1	Haskell Fixed Teacher Desk		1	BK-1	Haskell or eq.		1	
		CH-3	510 2thrive Swivel Chair - ScholarCraft		1	TA-8	Haskell Podium		1					
1105	CLASSROOM	CH-2	2thrive Chair - ScholarCraft		31	DK-2	ScholarCraft		31	ST-1	Diversified / TBD		1	
		CH-3	510 2thrive Swivel Chair - ScholarCraft		1	DK-3	Method Desk - ScholarCraft		1	ST-2	Haskell or eq.		1	
		CH-3	510 2thrive Swivel Chair - ScholarCraft		1	LN-1	Haskell Fixed Teacher desk		1	BK-1	Haskell or eq.		1	
		CH-3	510 2thrive Swivel Chair - ScholarCraft		1	TA-8	Haskell Podium		1					
1106	CLASSROOM	CH-2	2thrive Chair - ScholarCraft		31	DK-2	ScholarCraft		31	ST-1	Diversified / TBD		1	
		CH-3	510 2thrive Swivel Chair - ScholarCraft		1	DK-3	Method Desk - ScholarCraft		1	ST-2	Haskell or eq.		1	
		CH-3	510 2thrive Swivel Chair - ScholarCraft		1	LN-1	Haskell Fixed Teacher Desk		1	BK-1	Haskell or eq.		1	
		CH-3	510 2thrive Swivel Chair - ScholarCraft		1	TA-8	Haskell Podium		1					
1107	CLASSROOM	CH-2	2thrive Chair - ScholarCraft		31	DK-2	ScholarCraft		31	ST-1	Diversified / TBD		1	
		CH-3	510 2thrive Swivel Chair - ScholarCraft		1	DK-3	Method Desk - ScholarCraft		1	ST-2	Haskell or eq.		1	
		CH-3	510 2thrive Swivel Chair - ScholarCraft		1	LN-1	Haskell Fixed Teacher Desk		1	BK-1	Haskell or eq.		1	
		CH-3	510 2thrive Swivel Chair - ScholarCraft		1	TA-8	Haskell Podium		1					
1108	CLASSROOM	CH-2	2thrive Chair - ScholarCraft		31	DK-2	ScholarCraft		31	ST-1	Diversified / TBD		1	
		CH-3	510 2thrive Swivel Chair - ScholarCraft		1	DK-3	Method Desk - ScholarCraft		1	ST-2	Haskell or eq.		1	
		CH-3	510 2thrive Swivel Chair - ScholarCraft		1	LN-1	Haskell Fixed Teacher Desk		1	BK-1	Haskell or eq.		1	
		CH-3	510 2thrive Swivel Chair - ScholarCraft		1	TA-8	Haskell Podium		1					
1109	SCIENCE CLASSROOM	CH-2	2thrive Chair - ScholarCraft		34	DK-2	ScholarCraft		30	ST-1	Diversified / TBD		1	(4) Chairs w/ ADA
		CH-6	Diversified		32	LN-1	Haskell Fixed Teacher Desk		1	ST-2	Haskell or eq.		2	
		CH-8	2thrive Stool - ScholarCraft		1	(TABLES BUILT-IN)			1	BK-1	Haskell or eq.		2	
		CH-3	510 2thrive Swivel Chair - ScholarCraft		1	TA-8	Haskell Podium		1					
1109A	SCIENCE PREP		N/A				N/A							
1110	CLASSROOM	CH-2	2thrive Chair - ScholarCraft		31	DK-2	ScholarCraft		31	ST-1	Diversified / TBD		1	
		CH-3	510 2thrive Swivel Chair - ScholarCraft		1	DK-3	Method Desk - ScholarCraft		1	ST-2	Haskell or eq.		1	
		CH-3	510 2thrive Swivel Chair - ScholarCraft		1	LN-1	Haskell Fixed Teacher Desk		1	BK-1	Haskell or eq.		1	
		CH-3	510 2thrive Swivel Chair - ScholarCraft		1	TA-8	Haskell Podium		1					
1111	UNISEX RR		N/A				N/A							
1112	CLASSROOM	CH-2	2thrive Chair - ScholarCraft		31	DK-2	ScholarCraft		31	ST-1	Diversified / TBD		1	
		CH-3	510 2thrive Swivel Chair - ScholarCraft		1	DK-3	Method Desk - ScholarCraft		1	ST-2	Haskell or eq.		1	
		CH-3	510 2thrive Swivel Chair - ScholarCraft		1	LN-1	Haskell Fixed Teacher Desk		1	BK-1	Haskell or eq.		1	
		CH-3	510 2thrive Swivel Chair - ScholarCraft		1	TA-8	Haskell Podium		1					
1113	OFFICE	CH-9	T-3 Teknon		1	TA-7	Teknon Office		1					
		CH-4	Teknon Volume		1									
1114	SKILLED TRADES FAB LAB	CH-7	#6418H Granger		36	TA-5	Diversified / Granger		9	ST-5	Global Industrial #W62257484		2	Confirm Student Count requested by Instructor is ok with Admin
		CH-3	510 2thrive Swivel Chair - ScholarCraft		1	DK-3	Method Desk - ScholarCraft		1	ST-9	Granger #59LA60		2	
		CH-3	510 2thrive Swivel Chair - ScholarCraft		1	LN-1	Haskell Fixed Teacher Desk		1	ST-10	Granger #41D990		2	
		CH-3	510 2thrive Swivel Chair - ScholarCraft		1	TA-8	Haskell Podium		1	ST-11	Granger #119502		1	
1114A										ST-5	Global Industrial #W62257484		1	
										ST-4	#5JL48-Granger		4	
1115	CUSTODIAL									ST-6	#A536C - Granger		1	
1116	ENGINEERING & DESIGN	CH-2	2thrive Chair - ScholarCraft		31	TA-3	6700 Series ScholarCraft		15	BK-1	Haskell or eq.		1	
		CH-3	510 2thrive Swivel Chair - ScholarCraft		1	DK-3	Method Desk - ScholarCraft		1					
		CH-3	510 2thrive Swivel Chair - ScholarCraft		1	LN-1	Haskell Fixed Teacher Desk		1					
		CH-3	510 2thrive Swivel Chair - ScholarCraft		1	TA-2	6700 Series ScholarCraft(Single)		1					
		CH-3	510 2thrive Swivel Chair - ScholarCraft		1	TA-8	Haskell Podium		1					
1116A	OFFICE	CH-9	T-3 Teknon		1	TA-7	Teknon Office		1					
		CH-4	Teknon Volume		1									
1117	ELECTRICAL		N/A											
1118	IDF		N/A											
1119	OFFICE	CH-9	T-3 Teknon		1	TA-7	Teknon Office		1					
		CH-4	Teknon Volume		1									
SECOND FLOOR														
1201	GIRLS TOILET		N/A											
1202	BOYS TOILET		N/A											
1203	CLASSROOM	CH-2	2thrive Chair - ScholarCraft		31	DK-2	ScholarCraft		31	ST-1	Diversified / TBD		1	
		CH-3	510 2thrive Swivel Chair - ScholarCraft		1	DK-3	Method Desk - ScholarCraft		1	ST-2	Haskell or eq.		1	
		CH-3	510 2thrive Swivel Chair - ScholarCraft		1	LN-1	Haskell Fixed Teacher Desk		1	BK-1	Haskell or eq.		1	
		CH-3	510 2thrive Swivel Chair - ScholarCraft		1	TA-8	Haskell Podium		1					
1204	FLEX 2	CH-4	Teknon Volume		32	TA-1	Scholarcraft / Haskell TBD		16	ST-1	Diversified / TBD		1	32 in class due to double flip desks
		CH-3	510 2thrive Swivel Chair - ScholarCraft		1	DK-3	Method Desk - ScholarCraft		1	ST-2	Haskell or eq.		1	
		CH-3	510 2thrive Swivel Chair - ScholarCraft		1	LN-1	Haskell Fixed Teacher Desk		1	BK-1	Haskell or eq.		1	
		CH-3	510 2thrive Swivel Chair - ScholarCraft		1	TA-8	Haskell Podium		1					
1205	FLEX 1B	CH-4	Teknon Volume		32	TA-1	Scholarcraft / Haskell TBD		16	ST-1	Diversified / TBD		1	32 in class due to double flip desks
		CH-3	510 2thrive Swivel Chair - ScholarCraft		1	DK-3	Method Desk - ScholarCraft		1	ST-2	Haskell or eq.		1	
		CH-3	510 2thrive Swivel Chair - ScholarCraft		1	LN-1	Haskell Fixed Teacher Desk		1	BK-1	Haskell or eq.		1	
		CH-3	510 2thrive Swivel Chair - ScholarCraft		1	TA-8	Haskell Podium		1					
1205A	SMALL GROUP	CH-4	Teknon Volume		6	TA-1	Scholarcraft / Haskell TBD		2					
1205B	SMALL GROUP	CH-4	Teknon Volume		6	TA-1	Scholarcraft / Haskell TBD		2					
1206	FLEX 1A	CH-4	Teknon Volume		32	TA-1	Flip Desk ScholarCraft		16	ST-1	Diversified / TBD		1	32 in class due to double flip desks
		CH-3	510 2thrive Swivel Chair - ScholarCraft		1	DK-3	Method Desk - ScholarCraft		1	ST-2	Haskell or eq.		1	
		CH-3	510 2thrive Swivel Chair - ScholarCraft		1	LN-1	Haskell Fixed Teacher Desk		1	BK-1	Haskell or eq.		1	
		CH-3	510 2thrive Swivel Chair - ScholarCraft		1	TA-8	Haskell Podium		1					
1206A	SMALL GROUP	CH-4	Teknon Volume		6	TA-1	Scholarcraft / Haskell TBD		1					
1206B	SMALL GROUP	CH-4	Teknon Volume		6	TA-1	Scholarcraft / Haskell TBD		1					
1207	CLASSROOM	CH-2	2thrive Chair - ScholarCraft		31	DK-2	ScholarCraft		31	ST-1	Diversified / TBD		1	
		CH-3	510 2thrive Swivel Chair - ScholarCraft		1	DK-3	Method Desk - ScholarCraft		1	ST-2	Haskell or eq.		1	
		CH-3	510 2thrive Swivel Chair - ScholarCraft		1	LN-1	Haskell Fixed Teacher Desk		1					
		CH-3	510 2thrive Swivel Chair - ScholarCraft		1	TA-8	Haskell Podium		1					
1208	SCIENCE CLASSROOM 2	CH-2	2thrive Chair - ScholarCraft		34	DK-2	ScholarCraft		30	ST-1	Diversified / TBD		1	(4) Chairs w/ ADA
		CH-6	Diversified		32	LN-1	Haskell Fixed Teacher Desk		1	ST-2	Haskell or eq.		2	
		CH-8	2thrive Stool - ScholarCraft		1	(TABLES BUILT-IN)			1	BK-1	Haskell or eq.		2	
		CH-3	510 2thrive Swivel Chair - ScholarCraft		1	TA-8	Haskell Podium		1					
1208A	SCIENCE PREP 2		N/A				N/A							
1209	CLASSROOM	CH-2	2thrive Chair - ScholarCraft		31	TA-3	6700 Series ScholarCraft(Double)		15	ST-3	Haskell or eq.		2	
		CH-3	510 2thrive Swivel Chair - ScholarCraft		1	DK-3	Method Desk - ScholarCraft		1	BK-1	Haskell or eq.		1	
		CH-3	510 2thrive Swivel Chair - ScholarCraft		1	LN-1	Haskell Fixed Teacher Desk		1					
		CH-3	510 2thrive Swivel Chair - ScholarCraft		1	TA-2	6700 Series ScholarCraft(Single)		1					
		CH-3	510 2thrive Swivel Chair - ScholarCraft		1	TA-8	Haskell Podium		1					



May 26, 2020 Addendum

Fremont High School Furniture Package- Bldg. B



OAKLAND UNIFIED SCHOOL DISTRICT
Community Schools, Thriving Students

2 Furniture Code – Rooms Cont.

1437.00 - FREMONT HIGH SCHOOL
FURNITURE PROGRAMMING : ROOM CHART
21-May-20



ROOM NO.	ROOM NAME	CODE	CHAIR	TYPE	QTY	CODE	DESK/TABLE	TYPE	QTY	CODE	STORAGE/CABINETS/MISC.	TYPE	QTY	NOTES
1210	WORK ROOM	CH-4	Teknion Volume		12	TA-1	Flip Desk Scholar/Craft		6	ST-3 TA-4	Haskell or eq Diversified Counters		1 3	
1210A	STAFF RR		N/A											
1211	CLASSROOM	CH-2 CH-3	2thrive Chair - Scholar/Craft 510 2thrive Swivel Chair - Scholar/Craft		31 1	TA-3 DK-3 LN-1 TA-2 TA-8	8700 Series Scholar/Craft Method Desk - Scholar/Craft Haskell Fixed Teacher Desk 8700 Series Scholar/Craft(Single) Haskell Podium		15 1 1 1 1	ST-3 BK-1	Haskell or eq Haskell or eq		2 1	
1212	CUSTODIAL									ST-6	#A536C - Grainger		1	
1213	SMALL GROUP	CH-4	Teknion Volume		6	TA-1	Flip Desk Scholar/Craft		2					
1214	DIGITAL MEDIA B	CH-2 CH-3	2thrive Chair - Scholar/Craft 510 2thrive Swivel Chair - Scholar/Craft		32 1	TA-2 DK-3 LN-1 TA-3 TA-8	8700 Series Scholar/Craft Method Desk - Scholar/Craft Haskell Fixed Teacher Desk 8700 Series Scholar/Craft Haskell Podium		24 1 1 4 1	ST-3 ST-1 TA-4	Haskell or eq Diversified / TBD Diversified Counters		1 1 2	One desk/chair is a charging station
1214A	STORAGE									ST-6 ST-7	#A536C - Grainger A566C- Grainger		2 2	
1215	IDF		N/A											
1216	ELEC		N/A											
1217	DIGITAL MEDIA A	CH-2 CH-3	2thrive Chair - Scholar/Craft 510 2thrive Swivel Chair - Scholar/Craft		31 1	TA-3 DK-3 LN-1 TA-2 TA-8	8700 Series Scholar/Craft Method Desk - Scholar/Craft Haskell Fixed Teacher Desk 8700 Series Scholar/Craft(Single) Haskell Podium		15 1 1 1 1	TA-4	Diversified Counters		2	
1217B	EDIT	CH-3	510 2thrive Swivel Chair - Scholar/Craft		2	TA-3	8700 Series Scholar/Craft		1	ST-3	Haskell or eq		3	
1217C	VOCAL	CH-8	2thrive Stool - Scholar/Craft		1	TA-6	Cover Occasional Table - Teknion		1					
1217D	EDIT	CH-3	510 2thrive Swivel Chair - Scholar/Craft		2	TA-3	8700 Series Scholar/Craft		1	ST-3	Haskell or eq		3	
1218A	VIDEO CONTROL	CH-3	510 2thrive Swivel Chair - Scholar/Craft		2									
1218B	AUDIO CONTROL	CH-3	510 2thrive Swivel Chair - Scholar/Craft		2					ST-3	Haskell or eq		2	
1219	RECORDING STUDIO		TBD											



May 26, 2020 Addendum

Fremont High School Furniture Package- Bldg. B

2 Furniture Code Gym



OAKLAND UNIFIED SCHOOL DISTRICT
Community Schools, Thriving Students

1437.00 - FREMONT HIGH SCHOOL
FURNITURE PROGRAMMING : ROOM CHART
21-May-20



ROOM NO.	ROOM NAME	CODE	CHAIR	TYPE	QTY	COD	DESK/TABLE	TYPE	QTY	CODE	STORAGE/CABINETS/MISC.	TYPE	QTY	NOTES	
GYM															
	Gym										G-1 Pendulum Dual Rack Green Lower Yellow Uppers G-2 7 Texas Power Bar G-3 Pendulum Utility Bench Green G-4 Pendulum Monster Incline Arms Green G-5 Elliptical Cardio Machine G-6 Pendulum Dumbbell Rack 89" 3 Tier G-7 Pendulum 4Way Neck Machine Green lower Yellow Uppers Pendulum Mono Post Dip Bar(Knurled) G-8 Attachment Color, Green Pendulum Mono Post Dip Bar(Knurled) G-9 Attachment Color, Green G-10 Pendulum Leg Curl Green lower Yellow uppers G-11 Pendulum Leg Extension Green with yellow moving parts G-12 Upright Bike G-13 Tread Mill G-14 1530lbs Rubber 8 Sided Rubber Hex Dumbbells G-15 Pendulum Post Dip Bar Attachment Stage Black		3 10 7 4 2 1 2 2 5 2 2 2 3 1 4		
	Office	CH-9 CH-4	T-3 Teknion Teknion Volume		1 1		TA-7 Teknion Office*		1					* Storage Cabinet not included in TA-7 Pricing	
	Office	CH-9 CH-4	T-3 Teknion Teknion Volume		1 1		TA-7 Teknion Office*		1					* Storage Cabinet not included in TA-7 Pricing	
	Office	CH-9 CH-4	T-3 Teknion Teknion Volume		1 1		TA-7 Teknion Office*		1					* Storage Cabinet not included in TA-7 Pricing	
	Office	CH-9 CH-4	T-3 Teknion Teknion Volume		1 1		TA-7 Teknion Office*		1					* Storage Cabinet not included in TA-7 Pricing	
	Office	CH-9 CH-4	T-3 Teknion Teknion Volume		1 1		TA-7 Teknion Office*		1					* Storage Cabinet not included in TA-7 Pricing	
	CUSTODIAL									ST-6	#A536C - Grainger		1		



May 26, 2020 Addendum



Classroom

Student Chair – CH-2

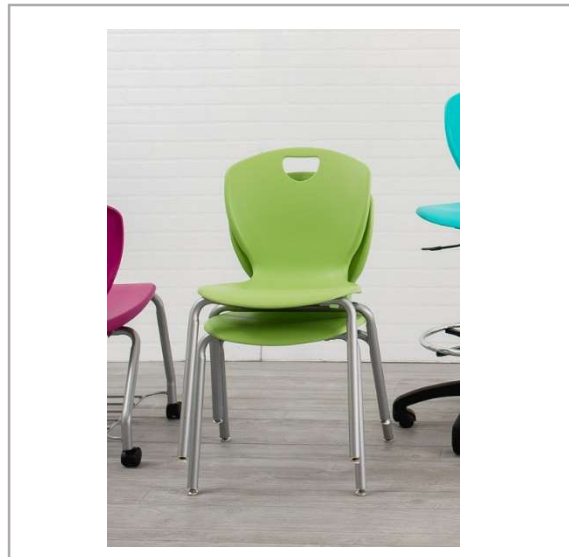

Image is representative of product style only and may not reflect option for each model

Manufacturer:	ScholarCraft
Model#:	#SC5100
Description:	2Thrive Chair
Finish:	“Greenery” Chair Polypropylene/Nickel Chrome Frame
Size:	18” Adult
Notes/Warranty:	Silent, Rubber cushioned Glides, 1” diameter/Lifetime



3 Furniture Code - Seating

Classroom

Teacher Chair – CH-3

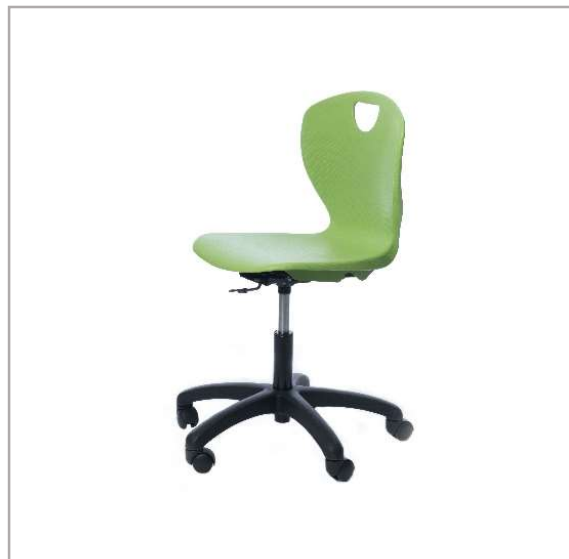

Image is representative of product style only and may not reflect option for each model

Manufacturer:	ScholarCraft
Model#:	#SC510
Description:	510 2thrive Series Shell Star Base Swivel Chair
Finish:	Greenery Color Polypropylene / Black Diamond Frame
Size:	15"-20" Adult
Notes/Warranty:	(5) Dual 2" hooded swivel casters/ Lifetime (10 year casters)



Flexroom

Office Group Chair – CH-4



Image is representative of product style only and may not reflect option for each model

Manufacturer: Teknion
Model#: VOLUME CHAIR NHSD
Description: Volume Stacking Chair, No arms, No Upholstery,
Finish: Espresso (TBC) and Back, Chrome, No Bookrack
Size: 19 $\frac{3}{4}$ "Wx21 $\frac{1}{2}$ "D x 32 $\frac{3}{4}$ "H
Notes/Warranty: Stacks 35H



3 Furniture Code - Seating

Flex Room

Flex Room Dolly CH-5



Image is representative of product style only and may not reflect option for each model

Manufacturer: Teknion
Model#: NHD W
Description: Dolly for CH-4
Finish: NA
Size: NA
Notes/Warranty: Hard Casters On Dolly



Science Classroom

Student Stool – CH-6



Image is representative of product style only and may not reflect option for each model

Manufacturer: Diversified Woodcraft
Model#: #STL9168-AL
Description: Metal Stool Black Metal /Hardwood Seat 16 gauge
Finish: steel fully welded
Size: Adjustable Height / Glides
Notes/Warranty: Limited Lifetime Warranty



Skill Trade Lab

Student Stool – CH-7



Image is representative of product style only and may not reflect option for each model

Manufacturer: Grainger 9KAW2
Model#: #6418H
Description: Round Stool with 19" to 27" Seat Height Range
Finish: and Gray /Steel
Size: 19"-27" Adult
Notes/Warranty: 300 lb. Weight Capacity, Gray



Science Classroom

Teacher Stool – CH-8



Image is representative of product style only and may not reflect option for each model

Manufacturer:	ScholarCraft
Model#:	#SC510L
Description:	510 2thrive Series Shell Star Base Swivel Stool
Finish:	Greenery Color Polypropylene / Black Diamond Frame
Size:	20"-28" Adult
Notes/Warranty:	(5) Dual 2" hooded swivel casters/ Lifetime (10 year casters)



3 Furniture Code - Seating

Office

Office Task Chair – CH-9



Image is representative of product style only and may not reflect option for each model

Manufacturer: Teknion
Model#: T-3 / NXXY
Description: Office Task Midback Adjust arms, Mesh Back, Chair
Finish: Black, Black Mesh, Ebony, Casters
Size: NA
Notes/Warranty: TBD



Classroom

Student Desk– DK-2

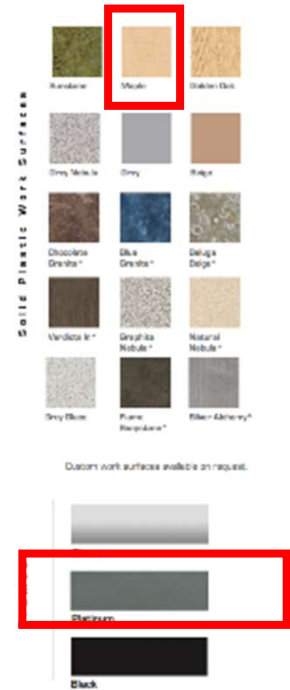

Image is representative of product style only and may not reflect option for each model

Manufacturer: Scholar Craft
Model#: 54500 SERIES
Description: Melsur Solid Plastic Top(Maple) Platinum Legs
Finish: 19" x 26" Top Height Adjustable 22"-30"
Size: Steel Base Glides
Notes/Warranty: Lifetime



Classroom

Teacher Desk– DK-3

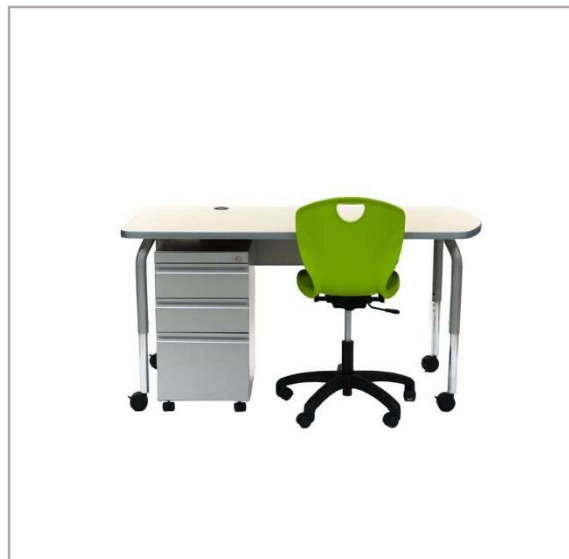

Image is representative of product style only and may not reflect option for each model

Manufacturer:	ScholarCraft
Model#:	#SC324
Description:	Method Series Teachers Desk
Finish:	Maple Top/Platinum Frame(TBC)
Size:	TBD 30x60"
Notes/Warranty:	Locked pedestal/ Lifetime (10 year casters)



Classroom

Lectern or Second Desk TBD– LN-1

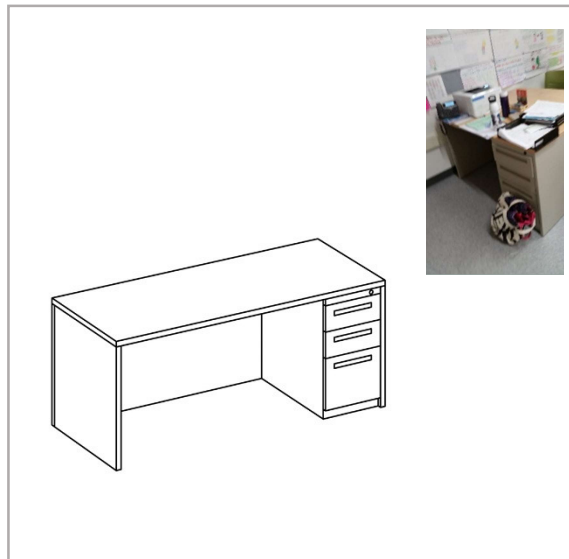

Image is representative of product style only and may not reflect option for each model

Manufacturer: Haskell
Model#: MARKET SERIES
Description: Single Pedestal Right Desk
Finish: Maple Laminate Top/Platinum Frame 5055PL(TBC)
Size: TBD 24x60"
Notes/Warranty: 3MM Fusion Maple Edge



3 Furniture Code – Desks/Tables

Classroom

Flip Desk– TA-1



Image is representative of product style only and may not reflect option for each model

Manufacturer: ScholarCraft
Model#: FS9100
Description: 9100 Flip-Top Table 24" x 60"
Finish: Desk Base: Platinum/ Fusion Maple Hard Plastic
Size: 24" x 60"x31"H Tilt Top
Notes/Warranty: Lifetime

Alternate for Pricing - Haskell



Desk Alternate
|
Haskell



Classroom

Student Desk– TA-1 (Alternate for pricing)



Image is representative of product style only and may not reflect option for each model

Manufacturer:	Haskell
Model#:	TBC
Description:	Assemble Series Flip-Top Table 24" x 60"
Finish:	Desk Base: Platinum/ Fusion Maple Top and 3MM Edge
Size:	24" x 60"x31"H Tilt Top
Notes/Warranty:	TBD



Classroom

Computer Table– TA-2



Image is representative of product style only and may not reflect option for each model

Manufacturer:	ScholarCraft
Model#:	FS879
Description:	8700 Series Computer Table
Finish:	Desk Base: Black/ Maple Top
Size:	24"x36"x22-29"H
Notes/Warranty:	Glides / Keyboard tray / CPU holders Lifetime Warranty



Classroom

Computer Table– TA-3(Double)



Image is representative of product style only and may not reflect option for each model

Manufacturer:	ScholarCraft
Model#:	FS879
Description:	8700 Series Computer Table
Finish:	Desk Base: Black/ Maple Top
Size:	24" x 60"x22-29"H
Notes/Warranty:	Glides/Keyboard tray/CPU holders/ Lifetime Warranty



Classroom

Millwork Table– TA-4

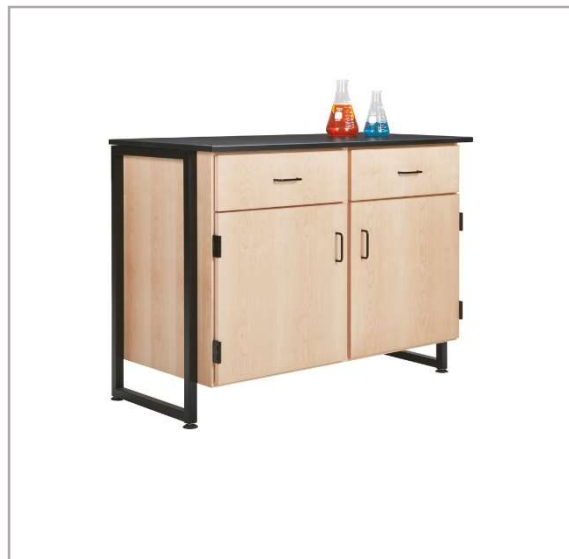

Image is representative of product style only and may not reflect option for each model

Manufacturer:	Diversified
Model#:	MV06-4824M-C
Description:	MOVE CABINET
Finish:	Desk Base: ChemGuard Top/ Maple
Size:	48"W x 24"D x 36"H
Notes/Warranty:	Cabinet is hung from a black powder-coated, 16-gauge steel support frame with nylon adjustable floor glides/Limited Lifetime / Units will have a 3/4" finished back panel /Locks



Classroom

Workbench– TA-5



Image is representative of product style only and may not reflect option for each model

Manufacturer: Grainger 1PB62
Model#: # WB-1-3672W
Description: Workbench, Butcher BlockDesk
Finish: Base: Grey / Butcher Block
Size: 36" Depth, 33-3/4" Height, 72" Width
Notes/Warranty: 4000 lb. Load Capacity



Classroom

End Table– TA-6



Image is representative of product style only and may not reflect option for each model

Manufacturer: Teknion
Model#: #STRTT
Description: Cover Occasional Table
Finish: Solid Surface Top Black/ Polished Aluminum Base
Size: 31" Depth, 26" Width , 18" Height
Notes/Warranty:

Office

Private Office– TA-7

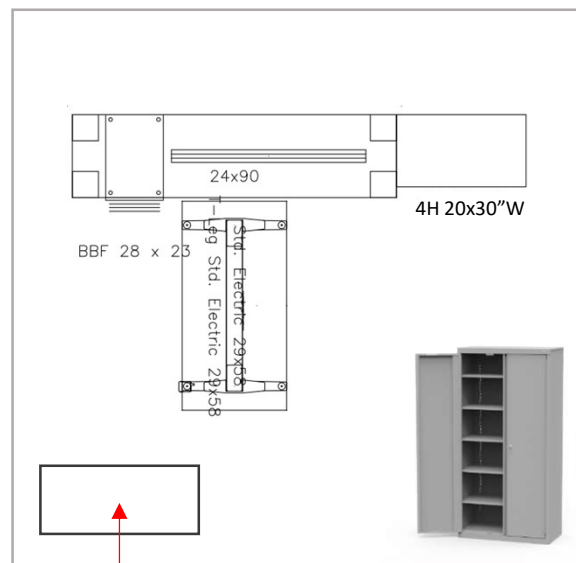
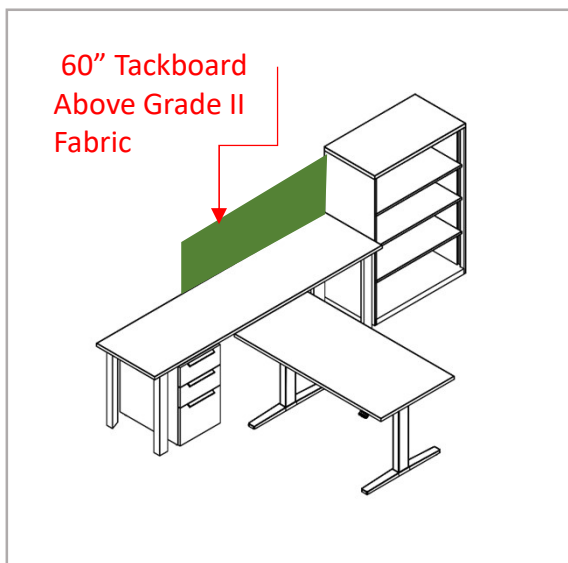

Image is representative of product style only and may not reflect option for each model

Classroom Offices include storage sim. To ST-2. Refer to plans

Manufacturer: Teknion
Model#: #TBC
Description: Private Office/Height Adjustable Desk/lockable mobile pedestal. /Soft Gris/Fusion/Choice Maple
Finish: Top/Tackable Panel Grade II panel fabric-green
Size: compliment Jade or Equal
Notes/Warranty: 8x10 Office

*3 Offices in Classroom Building include 1 storage cabinet, similar to a ST-2



Classroom

Podium– TA-8



Image is representative of product style only and may not reflect option for each model

Manufacturer:	Haskell
Model#:	Fuzion Sit to Stand Teacher's Desk
Description:	Adjustable Height Podium
Finish:	Soft Grey/TBC
Size:	TBC
Notes/Warranty:	Tablet Holder, water caddy, 28 ¼" H to 42" High



Existing
54"Wx24"Dx42"H



Storage
Alternate I

Classroom

Storage– ST-1 Alternate



Image is representative of product style only and may not reflect option for each model

Manufacturer:

Diversified

Model#:

#CABINET-2513-MPL385BRN38-GRY02

Description:

Mobile Storage Cabinet

Finish:

Fusion Maple / Silver Mist and Fusion Maple Edge

Size:

48"Wx28"Dx66"H

Notes/Warranty:

**Two Shelves, Two File Drawers, Two Paper Drawers,
And One Coat Rod, Locks**

3 Furniture Code – Storage/Accessories



Existing
54"Wx24"Dx42"H

Classroom

Storage– ST-1 Alternate



Image is representative of product style only and may not reflect option for each model

- Manufacturer:** Deskmakers
Model#: #TBC
Description: Mobile Storage Cabinet
Finish: Fusion Maple / Silver Mist and Fusion Maple Edge
Size: 48"Wx28"Dx66"H
Notes/Warranty: Two Shelves, lockable 4 Drawers, Two Paper Drawers, And One Coat Rod, Lockable



Classroom

Storage– ST-2

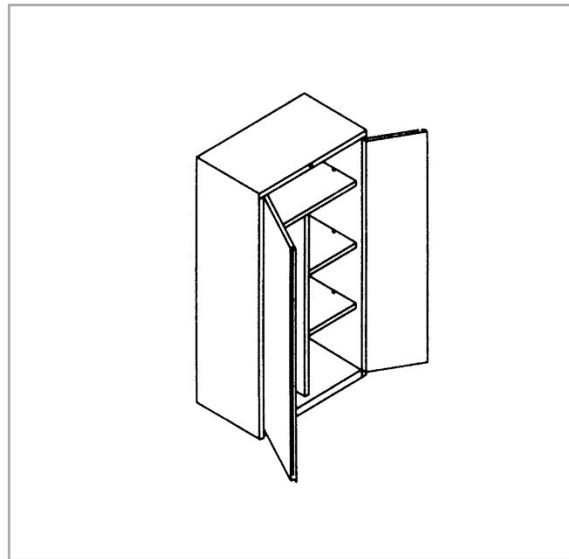

Image is representative of product style only and may not reflect option for each model

Manufacturer:	Haskell
Model#:	TBC
Description:	Wardrobe Tower
Finish:	Soft Grey TBC
Size:	24"Wx24"Dx64"H
Notes/Warranty:	Wardrobe/Storage Unit, 18"D with 2 Adjustable Shelves, Coat Hanger & 1 Hooks / Dealer to install and strap to wall



Classroom

Lockable Cabinets– ST-3

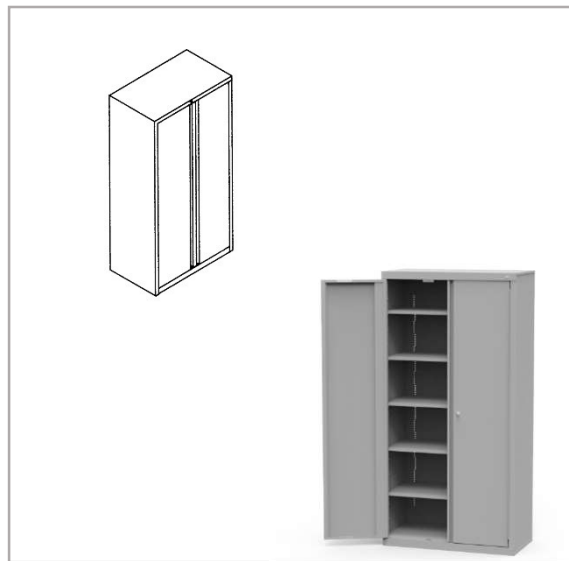

Image is representative of product style only and may not reflect option for each model

Manufacturer:	Haskell
Model#:	CAPTIVA SERIES
Description:	Industrial Metal Storage Cabinet
Finish:	Soft Grey TBC
Size:	36" x 18" x 72" Six Shelves
Notes/Warranty:	Locked Six Shelves / Dealer to install and strap to wall /15 year TBC



Classroom

Storage– BK-1

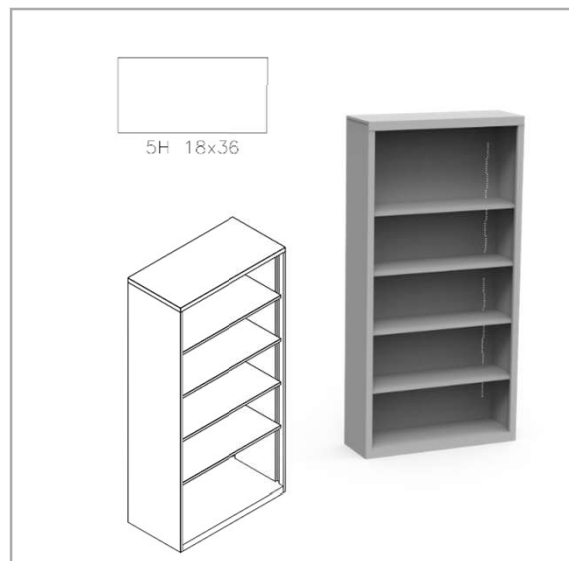

Image is representative of product style only and may not reflect option for each model

Manufacturer: Haskell
Model#: TBC
Description: Metal Bookcase
Finish: Soft Grey
Size: 36" x 18" x 72"
Notes/Warranty: Five Shelves /Dealer to install and strap to wall / 15 year



Classroom

Refrigerator– RF-1

Owner
Supplied

Image is representative of product style only and may not reflect option for each model

Manufacturer: TBD
Model#: #TBD
Description: Refrigerator
Finish: TBD
Size: 36" x 24" x 72"
Notes/Warranty:



Classroom

Material Cabinet– ST-4



Image is representative of product style only and may not reflect option for each model

Manufacturer:	Lyon/Grainger
Model#:	#5JL48
Description:	Metal Bin Cabinet
Finish:	Dove Grey
Size:	36" x 21" x 82"
Notes/Warranty:	16 bins/three Shelves / Dealer to install and strap to wall / 15 year TBC



Classroom

Tool Cabinet– ST-5



Image is representative of product style only and may not reflect option for each model

Manufacturer: Global Industrial
Model#: #WGB2257484
Description: Stor-More® LPC-9636 Loss Prevention Security Cabinet
Finish: Grey
Size: 96"W x 36"D x 84"H
Notes/Warranty: All-Steel Construction - Made from sturdy, 10-gauge welded-wire mesh panels on a 2" x 2" frame made of 14-gauge tube. Right Locking hinged doors include a built-in Adams Rite cylinder lock and 2 keys./ net price to compete \$00.00 confirm



Storage Rooms

Shelving– ST-6



Image is representative of product style only and may not reflect option for each model

Manufacturer:	Metro/Grainger 9DZP0
Model#:	#A536C
Description:	Starter Wire Shelving Unit
Finish:	Chrome Plated Finish, Silver
Size:	36"Wx24"dX63"H
Notes/Warranty:	4 Shelves/ Dealer to install and strap to wall



Storage Rooms

Shelving– ST-7



Image is representative of product style only and may not reflect option for each model

Manufacturer:	Metro/Grainger 9KJ79
Model#:	#A566C
Description:	Starter Wire Shelving Unit
Finish:	Chrome Plated Finish, Silver
Size:	60"Wx24"dX63"H
Notes/Warranty:	4 Shelves/ Dealer to install and strap to wall



Video Control Rooms

Server Rack– ST-8



Image is representative of product style only and may not reflect option for each model

Manufacturer:	43Y944 Schneider Electric/Grainger
Model#:	#AR3105
Description:	Data/Communication Cabinet Server Rack
Finish:	Black
Size:	42"Wx23"Dx83.62"H
Notes/Warranty:	tbd Shelves/ Dealer to install and strap to wall /



Skilled Trades Lab

Lumber Storage Rack– ST-9



Image is representative of product style only and may not reflect option for each model

Manufacturer: 59LA60Husky Rack & Wire/Grainger
Model#: #59LA58
Description: Steel Pallet Rack Add-On Unit,
Finish: Black
Size: 96"W x 48" D x 96"H
Notes/Warranty: tbd Shelves/Beams Evenly Spaced at 36"
This is an add on unit- Correct Spec.
Mounting to wall etc. / Mfr. Model #41D991



Skilled Trades Lab

Lumber Storage Rack– ST-10



Image is representative of product style only and may not reflect option for each model

Manufacturer: 59LA57Husky Rack & Wire/Grainger
Model#: #41D990
Description: Steel Pallet Rack
Finish: Orange Beams, Green uprights
Size: 96"W x 48" D x 96"H
Notes/Warranty: tbd Shelves/Beams Evenly Spaced at 36"

***Please include pricing for (10) Pallet Rack Wall Spacers – 6Lx3 1/4Wx1 5/8"H to be mounted to wall prior to installation**



Skilled Trades Lab

Flammable Cabinet– ST-11



Image is representative of product style only and may not reflect option for each model

Manufacturer:	Grainger(Justrite) Mfr. Model 899000
Model#:	#1YNG2
Description:	Flammable Cabinet, Manual Safety Cabinet Door
Finish:	Yellow
Size:	43"W x 43" D x 65"H
Notes/Warranty:	Standard steel safety storage cabinet. Designed for storing flammable liquids in containers with up to 5-gal. capacity. Constructed of fully welded 18-ga. galvanized steel with powder-coated finish. Features a U-Loc™



Fitness Room Equipment

G-1



Image is representative of product style only and may not reflect option for each model

Manufacturer: Rogers Athletic
Model#: #410993
Description: Pendulum Dual Rack
Finish: Green Lower Yellow Uppers Yellow
Size: N/A
Notes/Warranty:



Fitness Room Equipment

G-2

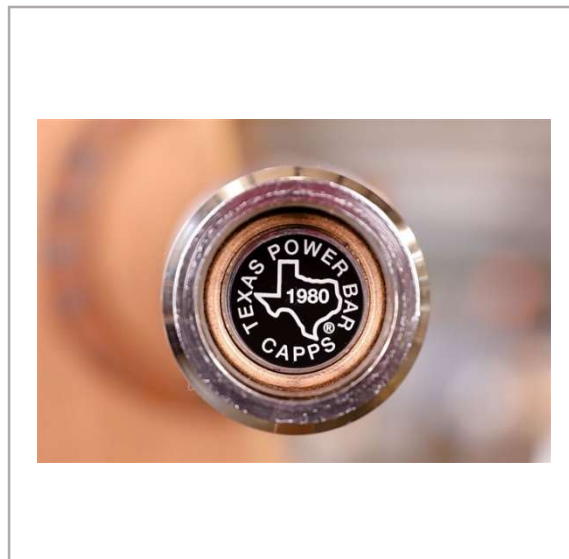

Image is representative of product style only and may not reflect option for each model

Manufacturer: Texas Power Bar
Model#: # N/A
Description: 7' Texas Power Bar
Finish: Steel
Size: 7'-0"
Notes/Warranty:



Fitness Room Equipment

G-3



Image is representative of product style only and may not reflect option for each model

Manufacturer: Rogers Athletic
Model#: #410947
Description: Pendulum Utility Bench
Finish: Green
Size: N/A
Notes/Warranty:



Fitness Room Equipment

G-4



Image is representative of product style only and may not reflect option for each model

Manufacturer: Rogers Athletic
Model#: #410513
Description: Pendulum Monster Incline Arms
Finish: Green
Size:
Notes/Warranty:



Fitness Room Equipment

G-5



Image is representative of product style only and may not reflect option for each model

Manufacturer: LifeFitness or Equal
Model#: #INTEGRITY SERIES ELLIPTICAL CROSS TRAINER
Description: Elliptical Cardio Machine Delux Base
Finish: Black
Size:
Notes/Warranty:



Fitness Room Equipment

G-6



Image is representative of product style only and may not reflect option for each model

Manufacturer: Rogers Athletic
Model#: #410846
Description: Pendulum Dumbbell Rack 89" 3 Tier
Finish: Silver/Black
Size: 89"
Notes/Warranty:



Fitness Room Equipment

G-7



Image is representative of product style only and may not reflect option for each model

Manufacturer: Rogers Athletic
Model#: #410679
Description: Pendulum 4Way Neck Machine
Finish: Green lower Yellow Uppers
Size: N/A
Notes/Warranty:



Fitness Room Equipment

G-8 & G-9



Image is representative of product style only and may not reflect option for each model

Manufacturer: Rogers Athletic
Model#: # 410879
Description: Pendulum Mono Post Dip Bar(Knurled) Attachment
Finish: Color, Green
Size: N/A
Notes/Warranty:



Fitness Room Equipment

G-10

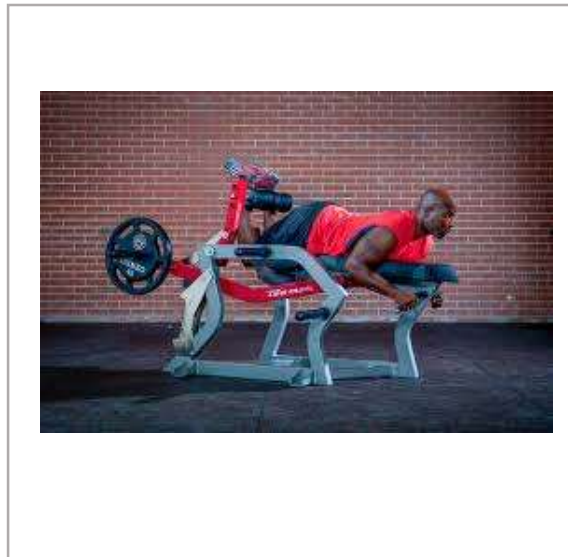

Image is representative of product style only and may not reflect option for each model

Manufacturer: Rogers Athletic
Model#: #N/A
Description: Pendulum Leg Curl
Finish: Green lower Yellow uppers
Size:
Notes/Warranty:



Fitness Room Equipment

G-11



Image is representative of product style only and may not reflect option for each model

Manufacturer: Rogers Athletic
Model#: #410756
Description: Pendulum Leg Extension
Finish: Green with yellow moving parts
Size: N/A
Notes/Warranty:



Fitness Room Equipment

G-12



Image is representative of product style only and may not reflect option for each model

Manufacturer:	LifeFitness or Equal
Model#:	ACTIVATE SERIES LIFECYCLE
Description:	Upright Exercise Bike
Finish:	Black
Size:	N/A
Notes/Warranty:	Console



Fitness Room Equipment

G-13



Image is representative of product style only and may not reflect option for each model

Manufacturer: LifeFitness or Equal
Model#: #ACTIVATE SERIES
Description: Tread Mill
Finish: Black/Silver
Size:
Notes/Warranty:



Fitness Room Equipment

G-14



Image is representative of product style only and may not reflect option for each model

Manufacturer: Troy Barbell
Model#: #N/A
Description: 1530lbs Rubber 8 Sided Rubber Hex Dumbbells
Finish: Black
Size: N/A
Notes/Warranty:



Fitness Room Equipment

G-15

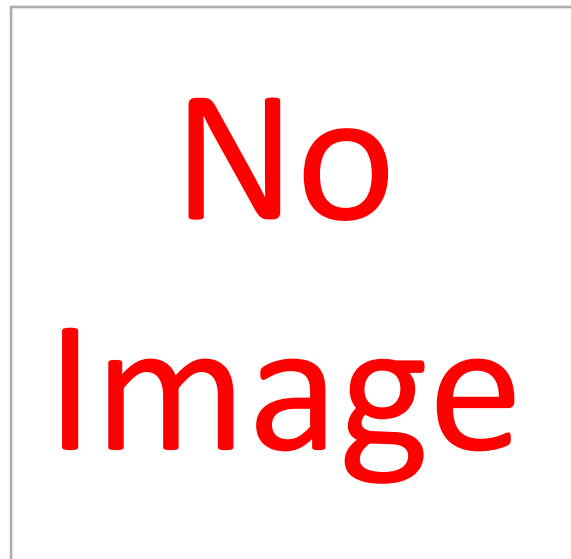

Image is representative of product style only and may not reflect option for each model

Manufacturer: Rogers Athletic
Model#: #
Description: Pendulum Post Dip Bar Attachment
Finish: Stage Black
Size: N/A
Notes/Warranty:

Fremont High School Furniture Package- Bldg. B



OAKLAND UNIFIED SCHOOL DISTRICT
Community Schools, Thriving Students

4 Rooms- Classroom Typ.

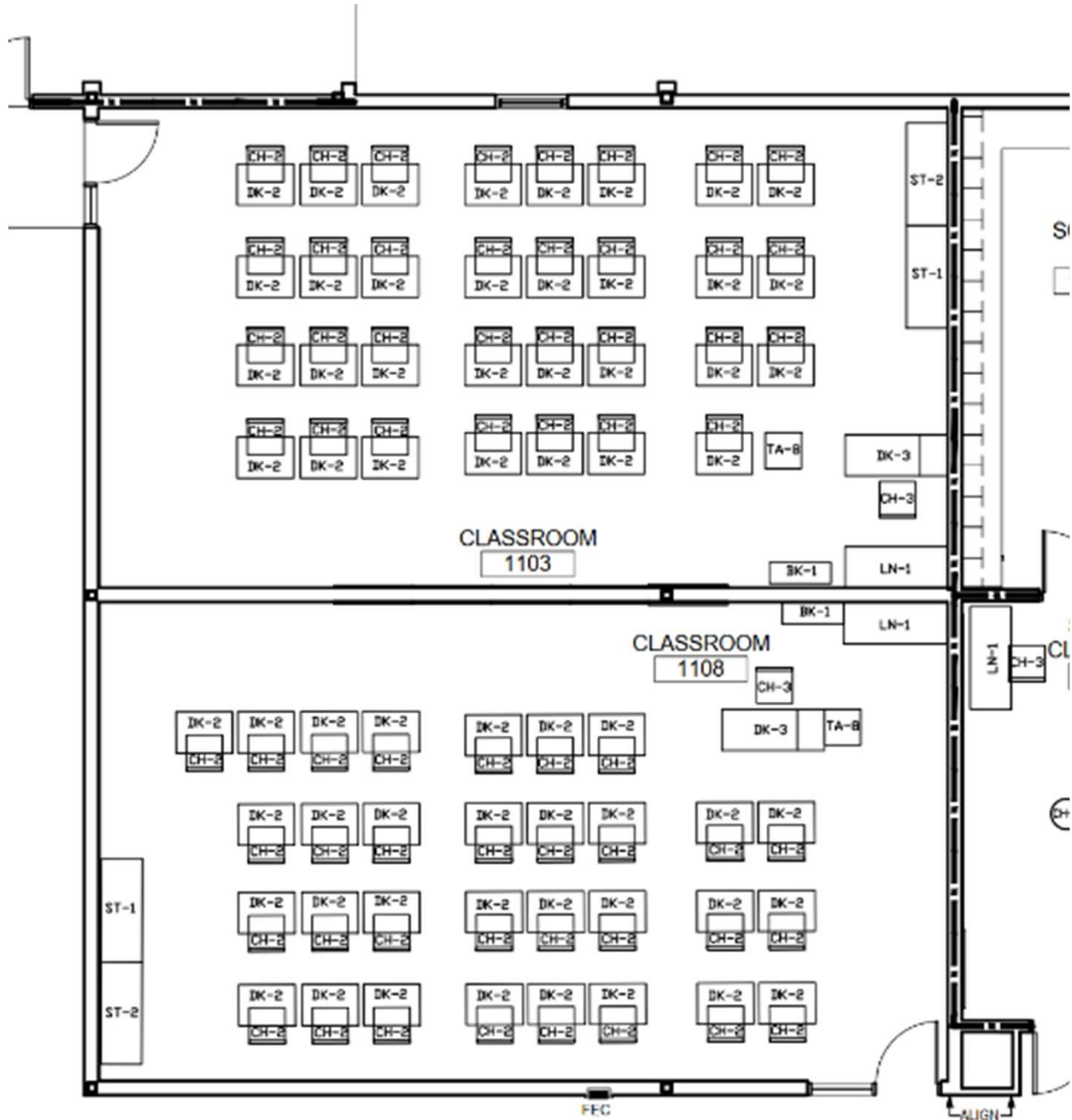

Level 1

Scale: NTS



May 26, 2020 Addendum



4 Rooms -Engineering & Design Classroom

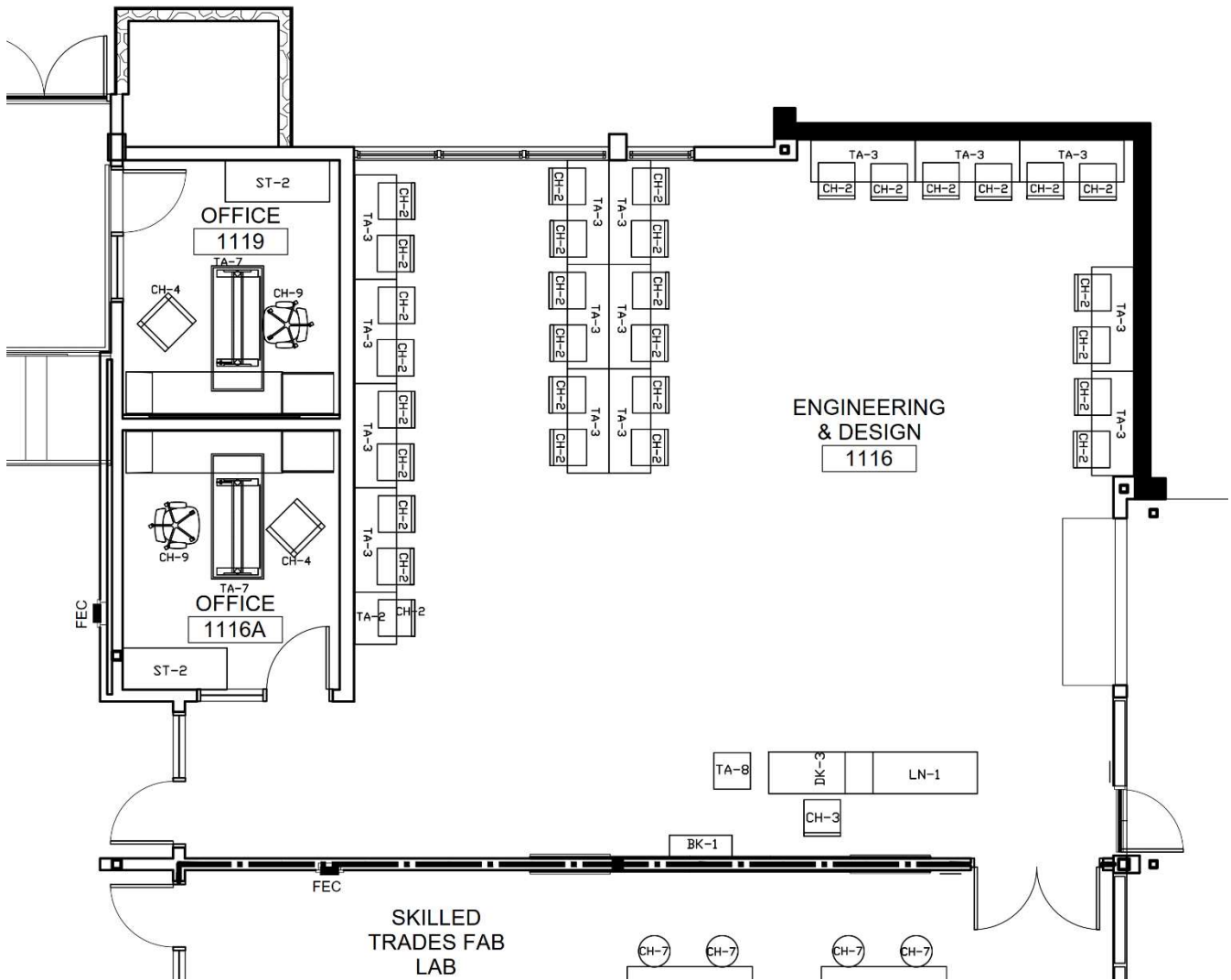

Level 1

Scale: NTS



Fremont High School Furniture Package- Bldg. B



OAKLAND UNIFIED
SCHOOL DISTRICT
Community Schools, Thriving Students

4 Room - Skilled Trades Fab Lab

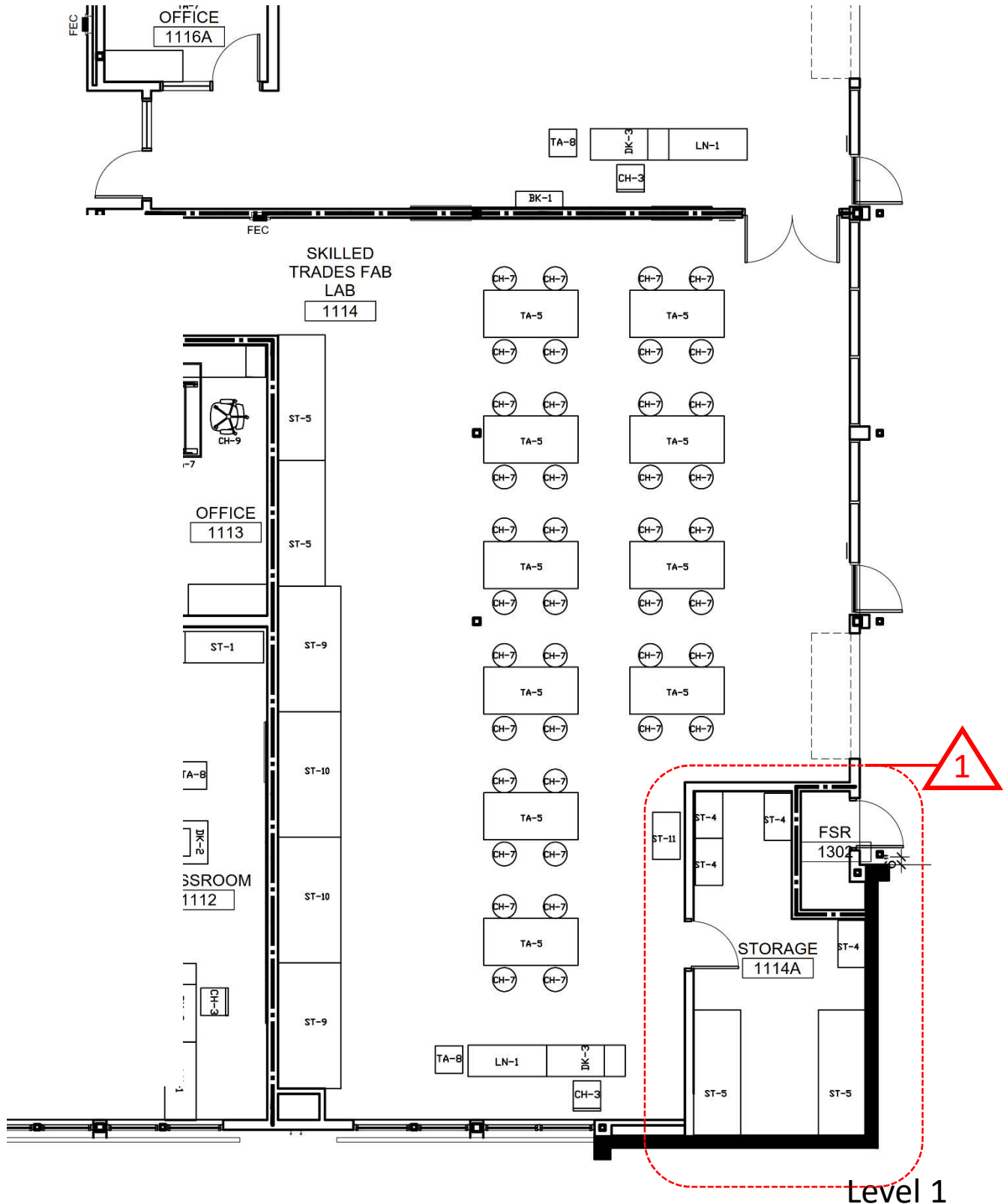

Level 1

Scale: NTS



May 26, 2020 Addendum



4 Rooms – Office/Intervention Room

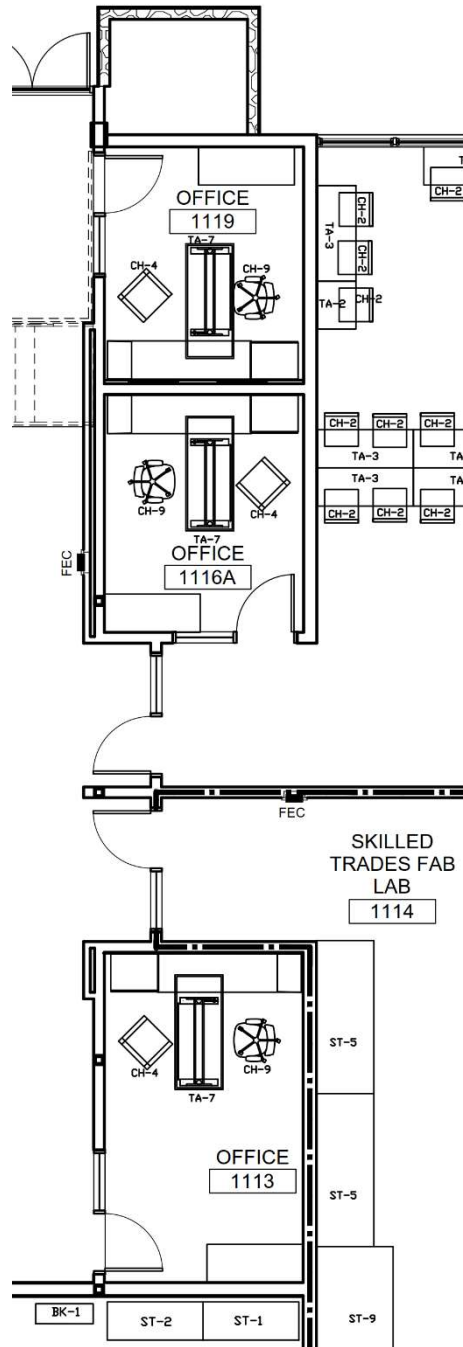

Level 1

Scale: NTS





4 Rooms - Public Services Typical

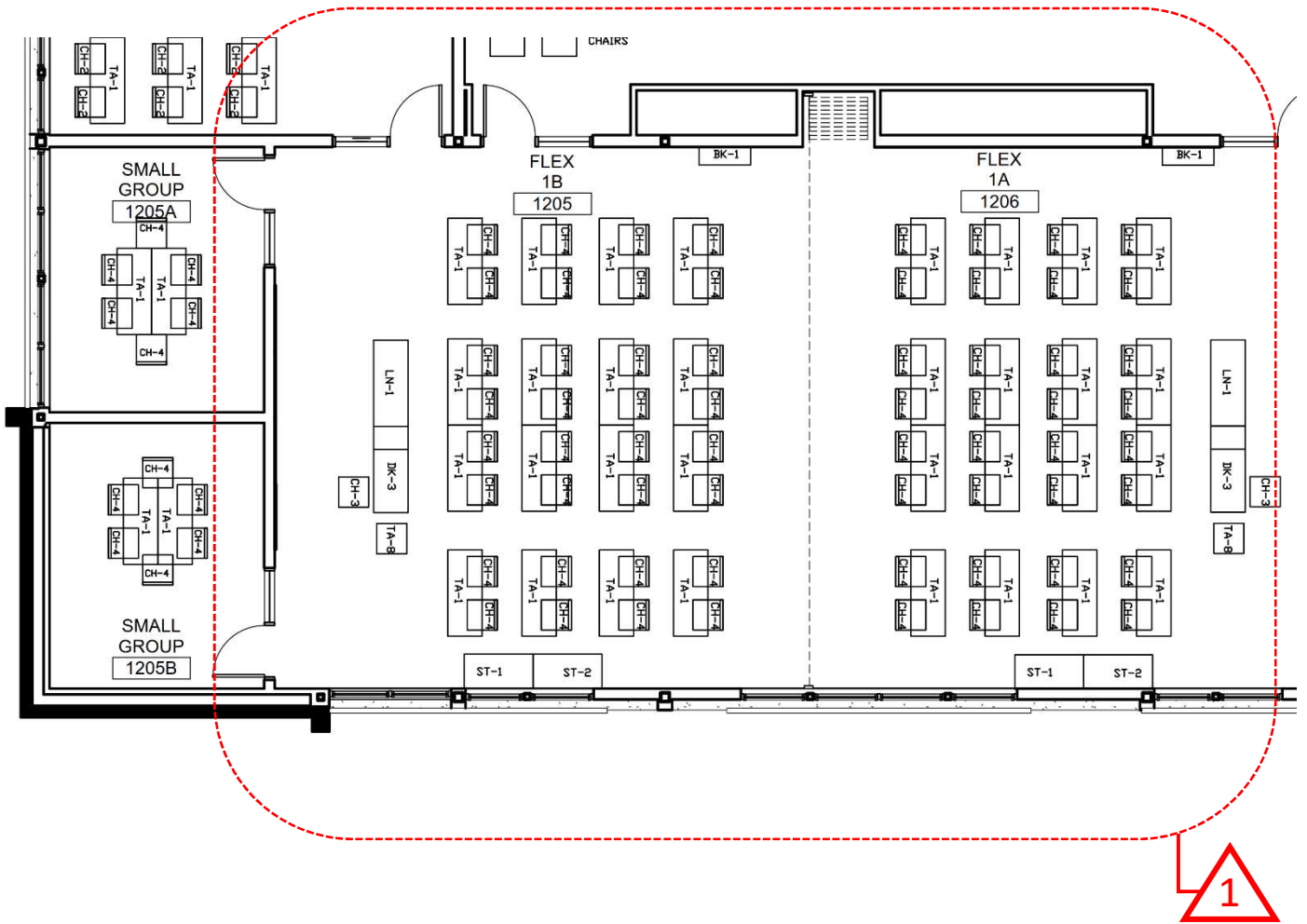

Level 2

Scale: NTS



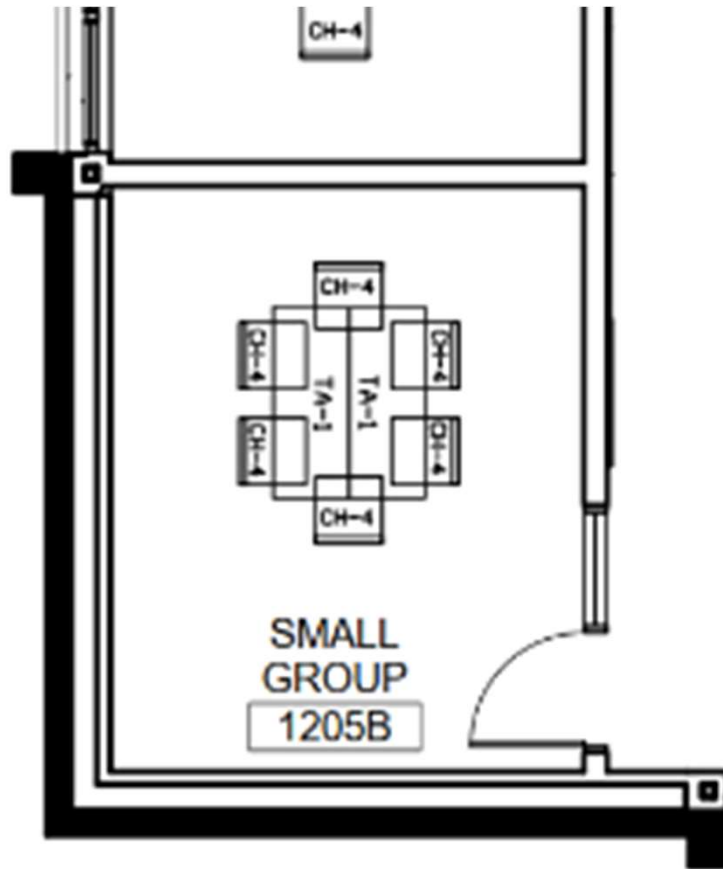

Level 2

Scale: NTS



4 Rooms - CTE Classroom

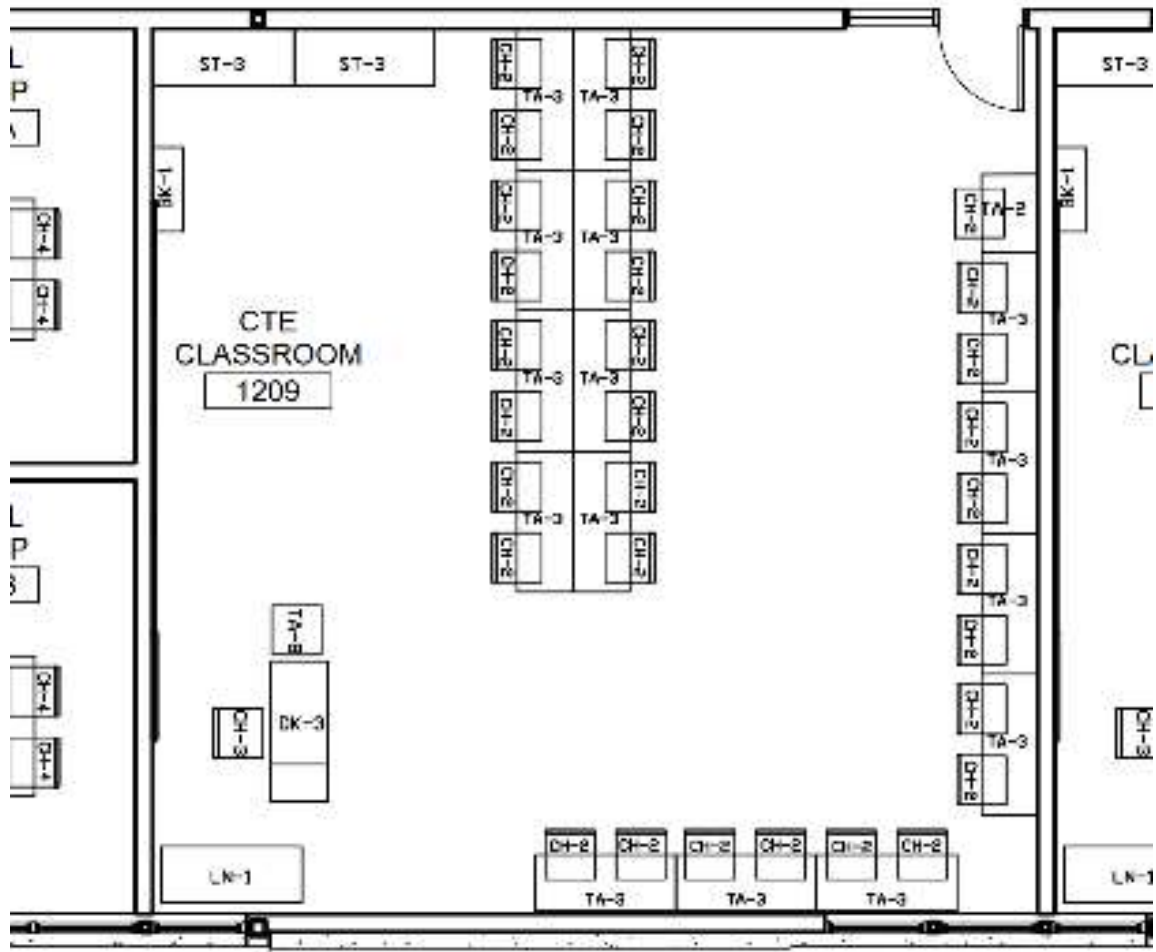

Level 2

Scale: NTS





4 Rooms - CTE Classroom



Level 2

Scale: NTS



May 26, 2020 Addendum



4 Rooms - Digital Media A Classroom

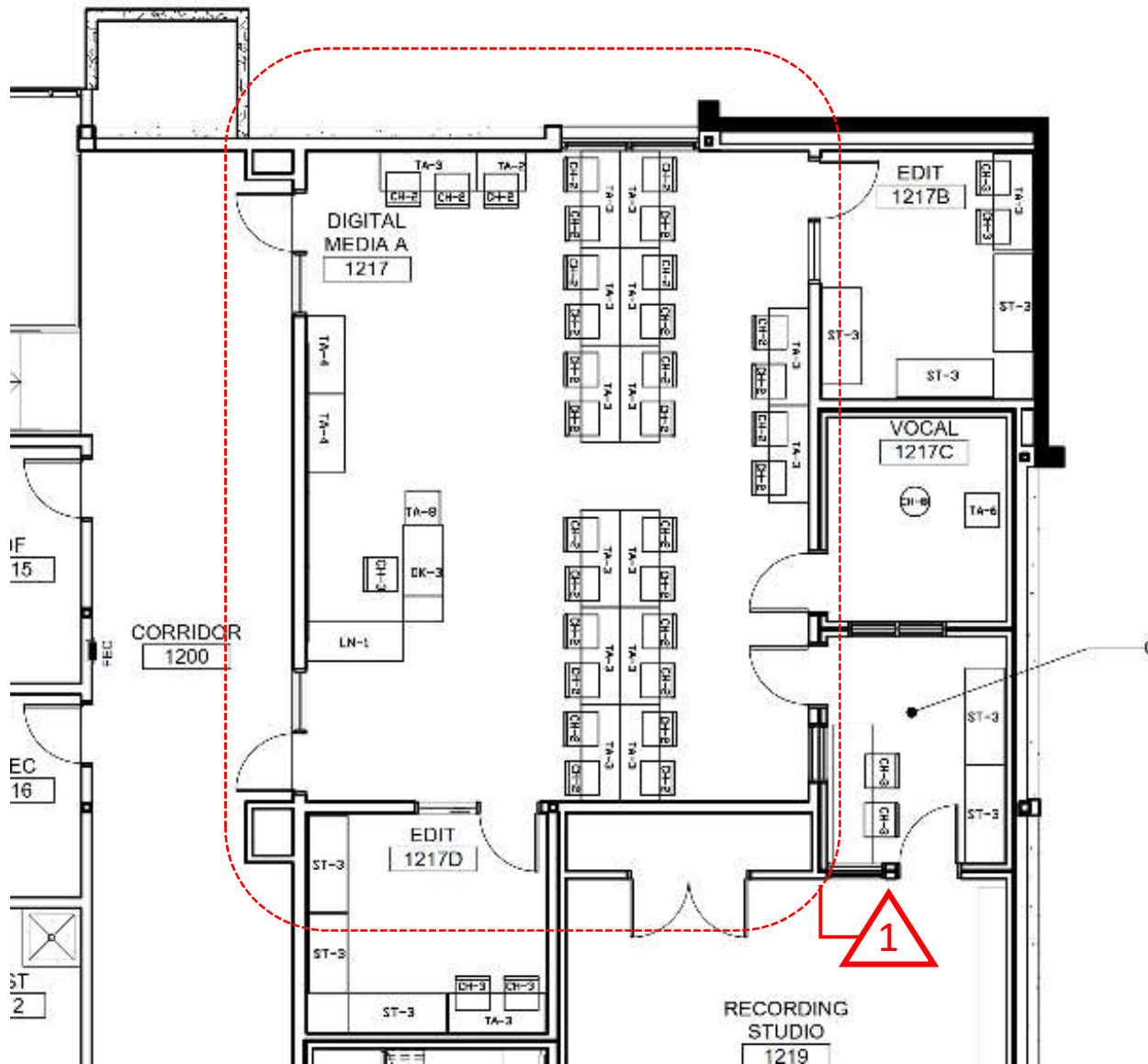

Level 2

Scale: NTS





4 Rooms - Recording Studio

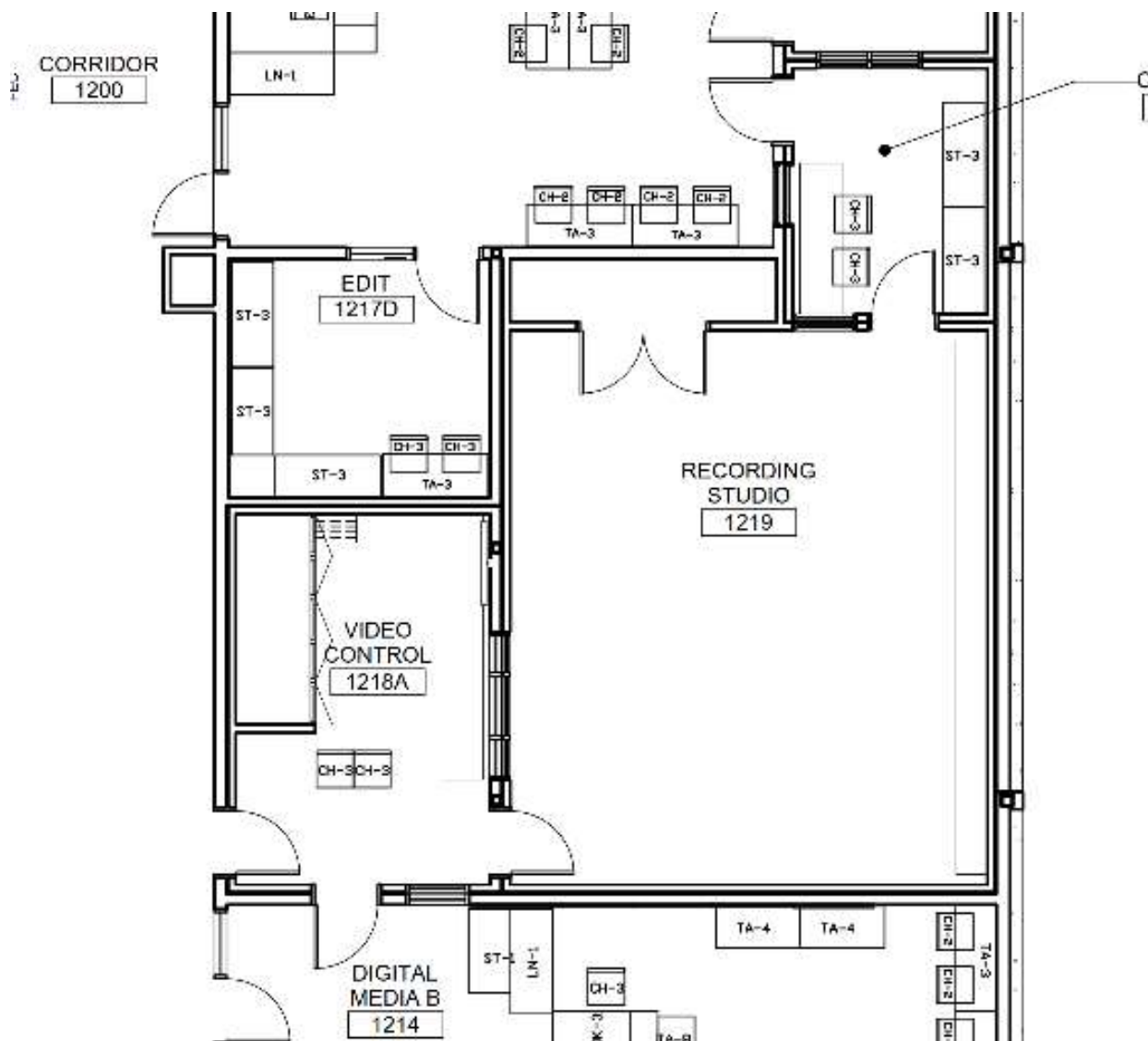

Level 2

Scale: NTS



May 26, 2020 Addendum



4 Rooms - Digital Media B Classroom

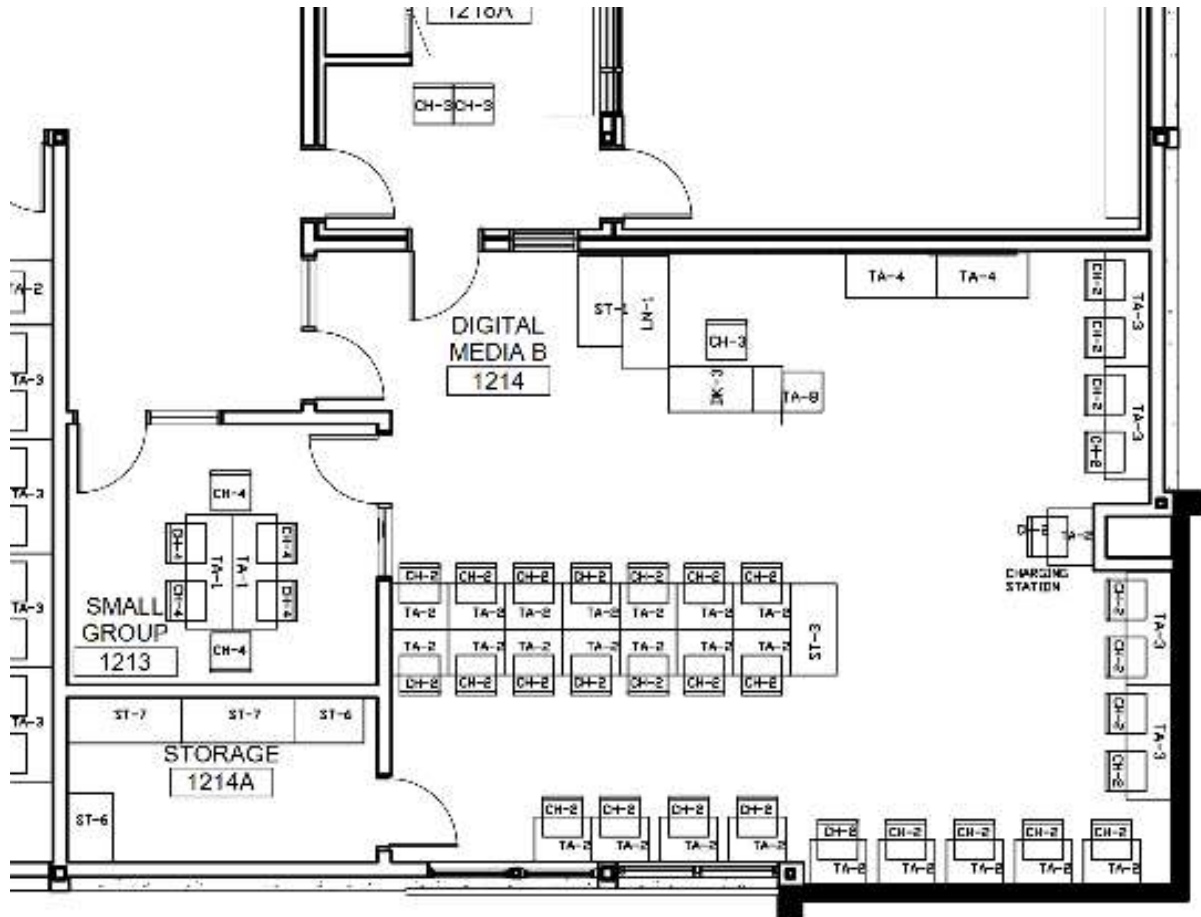

Level 2

Scale: NTS





4 Workroom and Custodial Typ.



Level 2

Scale: NTS





5 Fitness Room

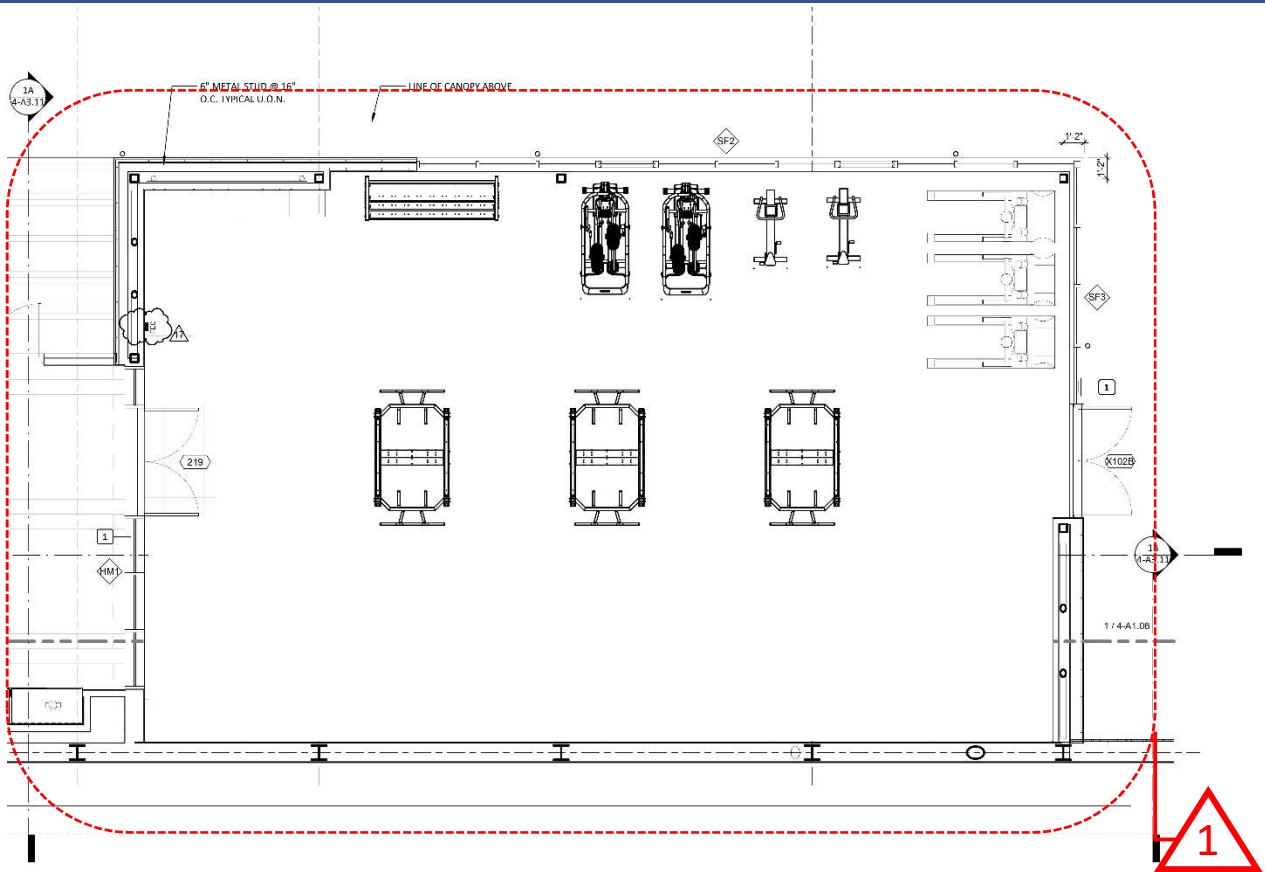

G-1	Pendulum Dual Rack Green Lower Yellow Uppers	3
G-2	7' Texas Power Bar	10
G-3	Pendulum Utility Bench Green	7
G-4	Pendulum Monster Incline Arms Green	4
G-5	Elliptical Cardio Machine	2
G-6	Pendulum Dumbbell Rack 89" 3 Tier	1
G-7	Pendulum 4Way Neck Machine Green lower Yellow Uppers	2
G-8	Pendulum Mono Post Dip Bar(Knurled) Attachment Color, Green	5
G-9	Pendulum Mono Post Dip Bar(Knurled) Attachment Color, Green	5
G-10	Pendulum Leg Curl Green lower Yellow uppers	2
G-11	Pendulum Leg Extension Green with yellow moving parts	2
G-12	Upright Bike	2
G-13	Tread Mill	3
G-14	1530lbs Rubber 8 Sided Rubber Hex Dumbbells	1
G-15	Pendulum Post Dip Bar Attachment Stage Black	4

Gym

Scale: NTS



Gym

Scale: NTS



Gym

Scale: NTS

Oakland Unified School District
Division of Facilities Planning and Management

BID OPENING TABULATION SHEET

School: Fremont High School
Project: Increments 3 & 4 Furniture
Project #: 13158
Estimate: \$650,000

Date: Wednesday, June 3, 2020
Time: 11:00 AM
Project Mgr: Pam Henderson
Architect: N/A

↓



Signature of Witness to Bid

Signature of Bid Opener

Company: Merto Conract Group	Base Bid: \$603,807.19	Required Day of Bid:	
Address: 1111 Broadway Ste. 1650	Allowance: \$20,000.00	Signed Bid Form	X
City/State: Oakland, CA	TOTAL: \$623,807.19	Addendum Acknow.	X
Phone: 510-254-4281	Alternates:	Bid Bond	
Fax:		Non-Collusion	X
		Iran Contracting Certification	
	<u>Time Submitted</u> <u>Date Submitted</u>	Site Visit Certification	
	10:11 AM 6/3/2020	Contractor's Sub List	
		Debarment Suspension & Schd Z	X
		Local Business Participation Form	X
	<u>Time Opened</u> <u>Date Opened</u>	DVBE Forms	X
	11:15 AM 6/3/2020		
Company:	Base Bid:	Required Day of Bid:	
Address:	Allowance: \$20,000.00	Signed Bid Form	
City/State:	TOTAL:	Addendum Acknow.	
Phone:	Alternates:	Bid Bond	
Fax:		Non-Collusion	
		Iran Contracting Certification	
	<u>Time Submitted</u> <u>Date Submitted</u>	Site Visit Certification	
		Contractor's Sub List	
		Debarment Suspension & Schd Z	
		Local Business Participation Form	
	<u>Time Opened</u> <u>Date Opened</u>	DVBE Forms	
Company:	Base Bid:	Required Day of Bid:	
Address:	Allowance: \$20,000.00	Signed Bid Form	
City/State:	TOTAL:	Addendum Acknow.	
Phone:	Alternates:	Bid Bond	
Fax:		Non-Collusion	
		Iran Contracting Certification	
	<u>Time Submitted</u> <u>Date Submitted</u>	Site Visit Certification	
		Contractor's Sub List	
		Debarment Suspension & Schd Z	
		Local Business Participation Form	
	<u>Time Opened</u> <u>Date Opened</u>	DVBE Forms	
Company:	Base Bid:	Required Day of Bid:	
Address:	Allowance: \$20,000.00	Signed Bid Form	
City/State:	TOTAL:	Addendum Acknow.	
Phone:	Alternates:	Bid Bond	
Fax:		Non-Collusion	
		Iran Contracting Certification	
	<u>Time Submitted</u> <u>Date Submitted</u>	Site Visit Certification	
		Contractor's Sub List	
		Debarment Suspension & Schd Z	
		Local Business Participation Form	
	<u>Time Opened</u> <u>Date Opened</u>	DVBE Forms	



OAKLAND UNIFIED
SCHOOL DISTRICT

Community Schools, Thriving Students

Department of Facilities Planning and Management

MEMORANDUM

Date: June 3, 2020

To: Juanita Hunter

From: Lupe Serrano, LBU Consultant

Subject: LBU Review Waiver

Project No. 13158 Fremont High School, Increment 3 & 4 Furniture

As required by the OUSD LBU Policy requirements, a review of the City of Oakland's database of certified firms was conducted to identify potential firms certified for this project. No local certified firms were identified.

Based on the findings, it is recommended to waive the LBU requirements for the above reference project based on the unavailability of certified LBE, SLBE or VSLBE firms to perform the work as required by the District.

Cc: Kenya Chapman
Tadashi Nakadegawa

Local Business Utilization Program Consultants



BID FORM
DOCUMENT 00 40 01

OAKLAND UNIFIED SCHOOL DISTRICT
Facilities Planning & Management
955 High Street, Upstairs Conference Room
Oakland, CA. 94601

Dear Board Members:

The undersigned, doing business under the firm name of Metro Contract Group, hereby proposes and agrees to enter into a contract, with the Oakland Unified School District ("Owner"), to furnish any and all labor, materials, applicable taxes, equipment and services for the completion of Work as described hereinafter and in the Contract Documents as **Fremont High School Increments 3 & 4 Furniture Project, 900 High Street, Oakland (the "Contract")**.

The Contract Documents were prepared by *Oakland Unified School District – Contract Specialist, 955 High Street, Oakland, 510-535-7044.*

The undersigned proposes to furnish such labor, materials, applicable taxes, equipment and services for the amount of Six Hundred Twenty Three Thousand, Eight Hundred Seven & Nineteen cents - This amount includes all allowances identified in the Agreement form (see Article IV), including but not limited to a contingency allowance of **Twenty Thousand dollars (\$20,000.00).**

The undersigned proposes to furnish such labor, materials, applicable taxes, equipment and services for the amount of;

<u>Six Hundred Three Thousand, Eight Hundred Seven & Nineteen cents</u>	Dollars \$	<u>603,807.19</u>
<i>Base Bid Amount</i>		
 <u>Twenty Thousand</u>	Dollars \$	<u>20,000.00</u>
<i>Contingency Amount</i>		
 <u>Six Hundred Twenty Three Thousand, Eight Hundred Seven & Nineteen</u>	Dollars \$	<u>623,807.19</u>
<i>Total Bid Amount</i>		
<i>Bidder acknowledges and agrees that the Total Bid accounts for any and all Allowance.</i>		

LOCAL BUSINESS PARTICIPATION WORKSHEET

PRIME:
 Project:
 Project #:
 Estimate:

Bid Opening Date:
 Time:
 Project Mgr:
 Architect:

Base Bid Dollar Amount	\$	Note: Please complete dollar amounts for sub/prime work, local business percentages, base bid			
	Total Dollar Amount of Work	LBE %	SLB%	SLBR%	City of Oakland Certification No.
PRIME Company: Metro Contract Group Address: 1111 Broadway - Ste 1650 City/State: Oakland, CA Phone: 510-254-4281	\$ 623,807.19	82%			7814
Company: Address: City/State: Phone:	\$				
Company: Address: City/State: Phone:	\$				
Company: Address: City/State: Phone:	\$				
Company: Address: City/State: Phone:	\$				
TOTAL PARTICIPATION	\$0.00	0.0%	0.0%	0.0%	0.0% 82

APPROVAL - LBU Compliance Officer

Note: Local Business Participation documentation must be submitted within 24 hours of bid opening

Additive/Deductive Alternates:

Alternate #1

	dollars \$ _____
--	------------------

The undersigned declares that Bidder has read and understands the Contract Documents, including, without limitation, the Notice to Bidders and the Instructions to Bidders, and agrees and proposes to furnish all necessary labor, materials, and equipment to perform and furnish all work in accordance with the terms and conditions of the Contract Documents, including, without limitation, the Drawings and Specifications of Bid No. 13158

(“Project” or “Contract”) and will accept in full payment for that Work the following total lump sum amount, all taxes included:

11.1.6.1 COURSE-OF-CONSTRUCTION INSURANCE REQUIREMENTS

Contractor, during the progress of the Work and until final acceptance of the Work by Owner upon Completion of the entire Contract, shall maintain Builder’s Risk/Course-of-Construction insurance satisfactory to the Owner, issued on a completed value basis on all insurable Work included under the Contract Documents. This insurance shall insure against all risks, including but not limited to the following perils: vandalism, theft, malicious mischief, fire, sprinkler leakage, civil authority, sonic boom, explosion, collapse, flood (for projects not solely funded through revenue bonds, “flood” excludes a tidal wave), earthquake (for projects not solely funded through revenue bonds, “earthquake” is limited to those of 3.5 or less on the Richter Scale in magnitude), wind, hail, lightning, smoke, riot or civil commotion, debris removal (including demolition) and reasonable compensation for the Architect’s services and expenses required as a result of such insured loss. This insurance shall provide coverage in an amount not less than the full cost to repair, replace or reconstruct the Work. Such insurance shall include the Owner, the Architect, and any

other person or entity with an insurable interest in the Work as an additional named insured.

The Contractor shall submit to the Owner for its approval all items deemed to be uninsurable under the Builder's Risk/Course-of Construction insurance. The risk of the damage to the Work due to the perils covered by the Builder's Risk/Course-of-Construction insurance, as well as any other hazard which might result in damage to the Work, is that of the Contractor and the surety, and no claims for such loss or damage shall be recognized by the Owner, nor will such loss or damage excuse the Complete and satisfactory performance of the Contract by the Contractor.

The undersigned certifies to the best of its knowledge and belief that it and its officials are not presently debarred, suspended, proposed for debarment, declared ineligible, or voluntarily excluded from covered transactions by any Federal department or agency according to Federal Acquisition Regulation Subpart 9.4, and by signing this bid certifies that this contractor does not appear on the Excluded Parties List.
<https://www.sam.gov/portal/public/SAM>

If written notice of the Award of Contract is mailed, faxed, or delivered to the undersigned at any time before this bid is withdrawn, the undersigned shall, within ten (10) days after the date of such mailing, faxing, or delivering of such notice, execute and deliver an agreement in the form of agreement present in these Contract Documents and give Performance and Payment Bonds in accordance with the specifications and bid as accepted.

The undersigned hereby designates as the office to which such Notice of Award of Contract may be mailed, faxed, or delivered:

1111 Broadway - Suite 1650, Oakland, CA 94607

Our Public Liability and Property Damage Insurance is placed with:

Ohio Casualty Insurance Company

Our Workers' Compensation Insurance is placed with:

State Compensation Insurance Fund of CA

Circular letters, bulletins, addenda, etc., bound with the specifications or issued during the time of bidding are included in the bid, and, in Completing the Contract, they are to become a part thereof.

The receipt of the following addenda to the specifications is acknowledged:

OAKLAND UNIFIED SCHOOL DISTRICT
Fremont High School
Increments 3 & 4 Furniture
Project No. 13158
May 15, 2020

BID FORM
DOCUMENT 00 40 01-3

Addendum No. 1 Date 5/26/20 Addendum No. _____ Date _____
Addendum No. _____ Date _____ Addendum No. _____ Date _____
Addendum No. _____ Date _____ Addendum No. _____ Date _____

This bid may be withdrawn at any time prior to the scheduled time for the opening of bids or any authorized postponement thereof.

A bidder shall not submit a bid unless the bidder's California contractor's license number appears clearly on the bid, the license expiration date and class are stated, and the bid contains a statement that the representations made therein are made under penalty of perjury. Any bid submitted by a contractor who is not licensed pursuant to Business and Professions Code section 7028.15 shall be considered nonresponsive and shall be rejected. Any bid not containing the above information may be considered nonresponsive and may be rejected.

NOTE: Each bid must give the full business address of the bidder and be signed by bidder with bidder's usual signature. Bids by partnerships must furnish the full name of all partners and must be signed in the partnership name by a general partner with authority to bind the partnership in such matters, followed by the signature and designation of the person signing. The name of the person signing shall also be typed or printed below the signature. Bids by corporations must be signed with the legal name of the corporation, followed by the name of the state of incorporation and by the signature and designation of the chairman of the board, president or any vice president, and then followed by a second signature by the secretary, assistant secretary, the chief financial officer or assistant treasurer. All persons signing must be authorized to bind the corporation in the matter. The name of each person signing shall also be typed or printed below the signature. Satisfactory evidence of the authority of the officer signing on behalf of a corporation shall be furnished.

The undersigned declares under penalty of perjury under the laws of the State of California that the representations made in this bid are true and correct.

Print or Type Name: Dwight Jackson
Title: President/CEO
Name of Company as Licensed in California: Metro Contract Group
Business Address: 1111 Broadway, Ste.1650, Oakland, CA 94607
Telephone Number: 510-254-4281
Email Address: dwright@metrocontractgroup.com
California Contractor License No.: N/A

OAKLAND UNIFIED SCHOOL DISTRICT
Fremont High School
Increments 3 & 4 Furniture
Project No. 13158
May 15, 2020

BID FORM
DOCUMENT 00 40 01-4

Class and Expiration Date: _____

Public Works Contractor Registration No.: _____

State of Incorporation, if Applicable: _____

() Evidence of authority to bind corporation is attached.

Dated: June 2, _____, 2020

Signed: Dwight Jackson _____



BUSIFUR-01

GALVANP

CERTIFICATE OF LIABILITY INSURANCE

DATE (MM/DD/YYYY)
4/6/2020

THIS CERTIFICATE IS ISSUED AS A MATTER OF INFORMATION ONLY AND CONFERS NO RIGHTS UPON THE CERTIFICATE HOLDER. THIS CERTIFICATE DOES NOT AFFIRMATIVELY OR NEGATIVELY AMEND, EXTEND OR ALTER THE COVERAGE AFFORDED BY THE POLICIES BELOW. THIS CERTIFICATE OF INSURANCE DOES NOT CONSTITUTE A CONTRACT BETWEEN THE ISSUING INSURER(S), AUTHORIZED REPRESENTATIVE OR PRODUCER, AND THE CERTIFICATE HOLDER.

IMPORTANT: If the certificate holder is an ADDITIONAL INSURED, the policy(ies) must have ADDITIONAL INSURED provisions or be endorsed. If SUBROGATION IS WAIVED, subject to the terms and conditions of the policy, certain policies may require an endorsement. A statement on this certificate does not confer rights to the certificate holder in lieu of such endorsement(s).

PRODUCER License # 0E67768 IOA Insurance Services 3875 Hopyard Road Suite 200 Pleasanton, CA 94588	CONTACT NAME: Mary Ann Cooksey PHONE (A/C, No, Ext): (925) 660-3517 50010 FAX (A/C, No): (925) 416-7869 E-MAIL ADDRESS: MaryAnn.Cooksey@ioausa.com														
INSURED Metro Contract Group 2150 N 1st Street, Suite 100 San Jose, CA 95131	<table border="1"><thead><tr><th>INSURER(S) AFFORDING COVERAGE</th><th>NAIC #</th></tr></thead><tbody><tr><td>INSURER A : Ohio Casualty Insurance Company</td><td>24074</td></tr><tr><td>INSURER B : Ohio Security Insurance Company</td><td>24082</td></tr><tr><td>INSURER C : American Fire & Casualty Company</td><td>24066</td></tr><tr><td>INSURER D : State Compensation Insurance Fund of CA</td><td>35076</td></tr><tr><td>INSURER E :</td><td></td></tr><tr><td>INSURER F :</td><td></td></tr></tbody></table>	INSURER(S) AFFORDING COVERAGE	NAIC #	INSURER A : Ohio Casualty Insurance Company	24074	INSURER B : Ohio Security Insurance Company	24082	INSURER C : American Fire & Casualty Company	24066	INSURER D : State Compensation Insurance Fund of CA	35076	INSURER E :		INSURER F :	
INSURER(S) AFFORDING COVERAGE	NAIC #														
INSURER A : Ohio Casualty Insurance Company	24074														
INSURER B : Ohio Security Insurance Company	24082														
INSURER C : American Fire & Casualty Company	24066														
INSURER D : State Compensation Insurance Fund of CA	35076														
INSURER E :															
INSURER F :															

COVERAGES CERTIFICATE NUMBER: REVISION NUMBER:

THIS IS TO CERTIFY THAT THE POLICIES OF INSURANCE LISTED BELOW HAVE BEEN ISSUED TO THE INSURED NAMED ABOVE FOR THE POLICY PERIOD INDICATED. NOTWITHSTANDING ANY REQUIREMENT, TERM OR CONDITION OF ANY CONTRACT OR OTHER DOCUMENT WITH RESPECT TO WHICH THIS CERTIFICATE MAY BE ISSUED OR MAY PERTAIN, THE INSURANCE AFFORDED BY THE POLICIES DESCRIBED HEREIN IS SUBJECT TO ALL THE TERMS, EXCLUSIONS AND CONDITIONS OF SUCH POLICIES. LIMITS SHOWN MAY HAVE BEEN REDUCED BY PAID CLAIMS.

INSR LTR	TYPE OF INSURANCE	ADDL INSD	SUBR WVD	POLICY NUMBER	POLICY EFF (MM/DD/YYYY)	POLICY EXP (MM/DD/YYYY)	LIMITS	
A	X COMMERCIAL GENERAL LIABILITY CLAIMS-MADE <input checked="" type="checkbox"/> OCCUR X Employees Benefits GEN'L AGGREGATE LIMIT APPLIES PER: POLICY <input type="checkbox"/> PRO-JECT <input type="checkbox"/> LOC OTHER:	X		BKO56005433	4/12/2020	4/12/2021	EACH OCCURRENCE	\$ 1,000,000
							DAMAGE TO RENTED PREMISES (Ea occurrence)	\$ 500,000
							MED EXP (Any one person)	\$ 15,000
							PERSONAL & ADV INJURY	\$ 1,000,000
							GENERAL AGGREGATE	\$ 2,000,000
							PRODUCTS - COMP/OP AGG	\$ 2,000,000
B	X AUTOMOBILE LIABILITY X ANY AUTO OWNED AUTOS ONLY X HIRED AUTOS ONLY <input checked="" type="checkbox"/> SCHEDULED AUTOS <input checked="" type="checkbox"/> NON-OWNED AUTOS ONLY	X		BAS56005433	4/12/2020	4/12/2021	COMBINED SINGLE LIMIT (Ea accident)	\$ 1,000,000
							BODILY INJURY (Per person)	\$
							BODILY INJURY (Per accident)	\$
							PROPERTY DAMAGE (Per accident)	\$
C	X UMBRELLA LIAB <input checked="" type="checkbox"/> OCCUR EXCESS LIAB <input type="checkbox"/> CLAIMS-MADE DED <input checked="" type="checkbox"/> RETENTION \$ 10,000			USA56005433	4/12/2020	4/12/2021	EACH OCCURRENCE	\$ 9,000,000
							AGGREGATE	\$ 9,000,000
D	X WORKERS COMPENSATION AND EMPLOYERS' LIABILITY ANY PROPRIETOR/PARTNER/EXECUTIVE OFFICER/MEMBER EXCLUDED? <input type="checkbox"/> (Mandatory in NH) If yes, describe under DESCRIPTION OF OPERATIONS below	N/A	X	9207311 - METRO	4/1/2020	4/1/2021	<input checked="" type="checkbox"/> PER STATUTE <input type="checkbox"/> OTH-ER	\$
							E.L. EACH ACCIDENT	\$ 1,000,000
							E.L. DISEASE - EA EMPLOYEE	\$ 1,000,000
							E.L. DISEASE - POLICY LIMIT	\$ 1,000,000

DESCRIPTION OF OPERATIONS / LOCATIONS / VEHICLES (ACORD 101, Additional Remarks Schedule, may be attached if more space is required)
Oakland Unified School District, its Directors, Officers, Employees, Agents, and Representatives are Additional Insured on Primary & Non-Contributory basis as respects to General Liability, and are Additional Insureds as respects to Auto Liability, as required by written contract.

Waiver of Subrogation applies to Workers Compensation, as required by written contract.

CERTIFICATE HOLDER

CANCELLATION

Oakland Unified School District Juanita Hunter, Specialist, Facilities Contracts & Bids Facilities Planning & Management Oakland, CA 94601	SHOULD ANY OF THE ABOVE DESCRIBED POLICIES BE CANCELLED BEFORE THE EXPIRATION DATE THEREOF, NOTICE WILL BE DELIVERED IN ACCORDANCE WITH THE POLICY PROVISIONS. AUTHORIZED REPRESENTATIVE <i>Jin Rabbit</i>
---	--

ENDORSEMENT AGREEMENT



WAIVER OF SUBROGATION
BLANKET BASIS

9207311
RENEWAL
SP
5-66-26-03
PAGE 1 OF 1

HOME OFFICE
SAN FRANCISCO

ALL EFFECTIVE DATES ARE
AT 12:01 AM PACIFIC
STANDARD TIME OR THE
TIME INDICATED AT
PACIFIC STANDARD TIME

METRO CONTRACT GROUP, INC.
2150 N 1ST ST STE 100
SAN JOSE, CA 95131

WE HAVE THE RIGHT TO RECOVER OUR PAYMENTS FROM ANYONE
LIABLE FOR AN INJURY COVERED BY THIS POLICY. WE WILL
NOT ENFORCE OUR RIGHT AGAINST THE PERSON OR
ORGANIZATION NAMED IN THE SCHEDULE.

THIS AGREEMENT APPLIES ONLY TO THE EXTENT THAT YOU
PERFORM WORK UNDER A WRITTEN CONTRACT THAT REQUIRES YOU
TO OBTAIN THIS AGREEMENT FROM US.

THE ADDITIONAL PREMIUM FOR THIS ENDORSEMENT SHALL BE
2.00% OF THE TOTAL POLICY PREMIUM.

SCHEDULE

<u>PERSON OR ORGANIZATION</u>	<u>JOB DESCRIPTION</u>
ANY PERSON OR ORGANIZATION FOR WHOM THE NAMED INSURED HAS AGREED BY WRITTEN CONTRACT TO FURNISH THIS WAIVER	BLANKET WAIVER OF SUBROGATION

NOTHING IN THIS ENDORSEMENT SHALL BE HELD TO VARY, ALTER, WAIVE OR EXTEND
ANY OF THE TERMS, CONDITIONS, AGREEMENTS, OR LIMITATIONS OF THIS POLICY
OTHER THAN AS ABOVE STATED. NOTHING ELSEWHERE IN THIS POLICY SHALL BE
HELD TO VARY, ALTER, WAIVE OR LIMIT THE TERMS, CONDITIONS, AGREEMENTS OR
LIMITATIONS IN THIS ENDORSEMENT.

COUNTERSIGNED AND ISSUED AT SAN FRANCISCO:

AUTHORIZED REPRESENTATIVE

PRESIDENT AND CEO



DIVISION OF FACILITIES PLANNING & MANAGEMENT ROUTING FORM

Project Information

Project Name	Fremont New Construction Project	Site	302
---------------------	----------------------------------	-------------	-----

Basic Directions

Services cannot be provided until the contract is awarded by the Board or is entered by the Superintendent pursuant to authority delegated by the Board.

Attachment Checklist	<input checked="" type="checkbox"/> Proof of general liability insurance, including certificates and endorsements, if contract is over \$15,000 <input checked="" type="checkbox"/> Workers compensation insurance certification, unless vendor is a sole provider
----------------------	---

Contractor Information

Contractor Name	Metro Contract Group	Agency's Contact	Dwight Jackson				
OUSD Vendor ID #	002836	Title	Manager				
Street Address	6800 Koll Center Parkway Suite 100	City	Pleasanton	State	CA	Zip	94566
Telephone	925-201-5947	Policy Expires					
Contractor History	Previously been an OUSD contractor? <input checked="" type="checkbox"/> Yes <input type="checkbox"/> No		Worked as an OUSD employee? <input type="checkbox"/> Yes <input checked="" type="checkbox"/> No				
OUSD Project #	13158						

Term of Original/Amended Contract

Date Work Will Begin (i.e., effective date of contract)	6-25-2020	Date Work Will End By (not more than 5 years from start date; for construction contracts, enter planned completion date)	10-23-2020
		New Date of Contract End (If Any)	

Compensation/Revised Compensation

If New Contract, Total Contract Price (Lump Sum)	\$623,807.19	If New Contract, Total Contract Price (Not To Exceed)	\$
Pay Rate Per Hour (if Hourly)	\$	If Amendment, Change in Price	\$
Other Expenses		Requisition Number	

Budget Information

If you are planning to multi-fund a contract using LEP funds, please contact the State and Federal Office before completing requisition.

Resource #	Funding Source	Org Key	Object Code	Amount
9650 9594	Fund 21 Measure J	210-9650-0-9594-8500-4432-302-9180-9905-9999-99999	4432	\$623,807.19

Approval and Routing (in order of approval steps)

Services cannot be provided before the contract is fully approved and a Purchase Order is issued. Signing this document affirms that to your knowledge services were not provided before a PO was issued.

	Division Head	Phone	510-535-7038	Fax	510-535-7082
1.	Acting Director, Facilities Planning and Management				
	Signature	Date Approved	6/8/20		
2.	General Counsel, Department of Facilities Planning and Management				
	Signature As to form only	Date Approved	6/8/2020		
3.	Interim Deputy Chief, Facilities Planning and Management				
	Signature	Date Approved	6/8/20		
4.	Chief Financial Officer				
	Signature	Date Approved			
5.	President, Board of Education				
	Signature	Date Approved			