

Board Office Use: Legislative File Info.	
File ID Number	23-2829
Introduction Date	1-24-2024
Enactment Number	24-0110
Enactment Date	1/24/2024 os



OAKLAND UNIFIED  
SCHOOL DISTRICT  
Community Schools, Thriving Students

## Memo (Bid Award)

**To** Board of Education

**From** Kyla Johnson-Trammell, Superintendent  
Preston Thomas, Chief Systems & Services Officer, Division of Facilities Planning and Management, Kenya Chatman, Executive Director of Facilities

**Board Meeting Date** January 24, 2024

**Subject** Agreement Between Owner and Contractor – Data Media Services – Various Sites  
Door Entry Systems Group 6 Project- Division of Facilities Planning and Management

**Action Requested** Approval by the Board of Education of Agreement Between Owner and Contractor by and between the **District** and Data Media Services, Stockton, CA, for the latter to provide installation of AIPhone door entry intercom systems at the following sites: Thornhill Elementary School, Oakland Academy of Knowledge, Lockwood Steam Academy, Lockwood CDC, & Kaiser Early Childhood Center for the **Various Sites Door Entry Systems Group 6 Project**, in the amount of **\$119,000.00**, which includes a contingency of **\$14,000.00**, as the lowest responsive bidder, with the work anticipated to commence on **January 25, 2024**, and required to be completed within ninety (90) days, with an anticipated ending of **April 23, 2024**.

**Discussion** Contractor was selected through competitive bidding. (Public Contract Code § 22037).

**LBP** (Local Business Participation Percentage) Waived

**Recommendation** Approval by the Board of Education of Agreement Between Owner and Contractor by and between the District and Data Media Services, Stockton, CA, for the latter to provide installation of AIPhone door entry intercom systems at the following sites: Thornhill Elementary School, Oakland Academy of Knowledge, Lockwood Steam Academy, Lockwood CDC, & Kaiser Early Childhood Center for the Various Sites Door Entry Systems Group 6 Project, in the amount of \$119,000.00, which includes a contingency of \$14,000.00, as the lowest responsive bidder, with the work anticipated to commence on January 25, 2024, and required to be completed within ninety (90) days, with an anticipated ending of April 23, 2024.

**Fiscal Impact** Fund 01, ESSER III

**Attachments**

- Contract Justification
- Agreement, Bonds, and Other Contract Documents
- Certificate of Insurance
- Routing Form



**CONTRACT JUSTIFICATION FORM**

**This Form Shall Be Submitted to the Board Office With Every Agenda Contract.**

**Legislative File ID No.** 23-2829

**Department:** Facilities Planning and Management

**Vendor Name:** Data Media Services

**Project Name:** Various Sites Door Entry System Group 6 **Project No.:** 23127  
Thornhill ES, Oakland Academy of Knowledge,  
Lockwood Steam Academy, Lockwood CDC, & Kaiser Early Childhood Center

**Contract Term:** Intended Start: January 25, 2024 Intended End: April 23, 2024

**Total Cost Over Contract Term:** \$119,000.00

**Approved by:** Preston Thomas

**Is Vendor a local Oakland Business or has it met the requirements of the**

**Local Business Policy?**  Yes (No if Unchecked)

**How was this contractor or vendor selected?**

Data Media Services was selected by the district as the lowest responsible and responsive bid.

**Summarize the services or supplies this contractor or vendor will be providing.**

Data Media Services will provide installation of iPhone door entry intercom systems at the following sites: Thornhill Elementary School, Oakland Academy of Knowledge, Lockwood Steam Academy, Lockwood CDC, & Kaiser Early Childhood Center for the Various Sites Door Entry Systems Group 6 Project.

**Was this contract competitively bid?**  Check box for "Yes" (If "No," leave box unchecked)

If "No," please answer the following questions:

1) How did you determine the price is competitive?

2) Please check the competitive bidding exception relied upon:

Construction Contract:

- Price is at or under UPCCAA threshold of \$60,000 (as of 1/1/19)
- CMAS contract [may only include “incidental work or service”] (Public Contract Code §§10101(a) and 10298(a)) – *contact legal counsel to discuss if applicable*
- Emergency contract (Public Contract Code §§22035 and 22050) – *contact legal counsel to discuss if applicable*
- No advantage to bidding (including sole source) – *contact legal counsel to discuss if applicable*
- Completion contract – *contact legal counsel to discuss if applicable*
- Lease-leaseback contract RFP process – *contact legal counsel to discuss if applicable*
- Design-build contract RFQ/RFP process – *contact legal counsel to discuss if applicable*
- Energy service contract – *contact legal counsel to discuss if applicable*
- Other: \_\_\_\_\_ – *contact legal counsel to discuss if applicable*

Consultant Contract:

- Architect, engineer, construction project manager, land surveyor, or environmental services – selected (a) based on demonstrated competence and professional qualifications (Government Code §4526), **and** (b) using a fair, competitive RFP selection process (Government Code §§4529.10 et seq.)
- Architect or engineer *when state funds being used* – selected (a) based on demonstrated competence and professional qualifications (Government Code §4526), (b) using a fair, competitive RFP selection process (Government Code §§4529.10 et seq.), **and** (c) using a competitive process consistent with Government Code §§4526-4528 (Education Code §17070.50)
- Other professional or specially trained services or advice – no bidding or RFP required (Public Contract Code §20111(d) and Government Code §53060) – *contact legal counsel to discuss if applicable*
- For services other than above, the cost of services is \$109,300 or less (as of 1/1/23)
- No advantage to bidding (including sole source) – *contact legal counsel to discuss if applicable*

Purchasing Contract:

- Price is at or under bid threshold of \$109,300 (as of 1/1/23)
- Certain instructional materials (Public Contract Code §20118.3)
- Data processing systems and supporting software – choose one of three lowest bidders (Public Contract Code §20118.1)

- Electronic equipment – competitive negotiation (Public Contract Code §20118.2) – *contact legal counsel to discuss if applicable*
- CMAS contract [may only include “incidental work or service”] (Public Contract Code §§10101(a) and 10298(a)) – *contact legal counsel to discuss if applicable*
- Piggyback contract for purchase of personal property (Public Contract Code §20118) – *contact legal counsel to discuss if applicable*
- Supplies for emergency construction contract (Public Contract Code §§22035 and 22050) – *contact legal counsel to discuss if applicable*
- No advantage to bidding (including sole source) – *contact legal counsel to discuss if applicable*
- Other: \_\_\_\_\_

Maintenance Contract:

- Price is at or under bid threshold of \$109,300 (as of 1/1/23)
- No advantage to bidding (including sole source) – *contact legal counsel to discuss*
- Other: \_\_\_\_\_

3) Explain in detail the facts that support the applicability of the exception marked above:

## **AGREEMENT BETWEEN OWNER AND CONTRACTOR**

This Agreement, effective **January 25, 2024**, is by and between the **Oakland Unified School District**, in Alameda County, California, hereinafter called the “Owner,” and **DATA MEDIA SERVICES, INC.** hereinafter called the “Contractor.”

**WITNESSETH:** That the Contractor and the Owner for the consideration hereinafter named agree as follows:

### **ARTICLE I. SCOPE OF WORK.**

The Contractor agrees to furnish all labor, equipment and materials, including tools, implements, and appliances required, and to perform all the work required, by the Contract (the “Work”) in a good and workmanlike manner, free from any and all liens and claims from mechanics, material suppliers, subcontractors, artisans, machinists, teamsters, freight carriers, and laborers, and as specified in

the Thornhill Elementary School, Oakland Academy of Knowledge, Lockwood Steam Academy, Lockwood CDC, & Kaiser Early Childhood Center Group 6 Project,

all in strict compliance with the plans, drawings and specifications therefore prepared by

OUSD, 955 High Street, Oakland, California, 94601, 510-535-7044,

and other Contract Documents relating thereto.

During the Work, the Contractor shall ensure that all Work, including but not limited to Work performed by Subcontractors, is performed in compliance with all applicable legal, contractual, and local government requirements related to COVID-19 and other public health emergencies, including “social distancing,” masks, and hygiene as may be ordered by the State or local authorities and as may be directed in the Contract Documents.

This contract is subject to the District’s Project Labor Agreement, dated June 30, 2021, which is available to upload found by going to the OUSD home page: [ousd.org](http://ousd.org) > Offices and Departs > Facilities Planning & Management Department > Click Opportunities drop-down > Project Labor Agreement(PLA) is at the bottom.

### **ARTICLE II. CONTRACT DOCUMENTS.**

The Contractor and the Owner agree that all of the documents listed in Article 1.1.1 of the General Conditions form the “Contract Documents” which form the “Contract.” The Contractor and its subcontractors must use the Owner’s program software COLBI DOCS for projects.

### ARTICLE III. TIME TO COMPLETE AND LIQUIDATED DAMAGES.

Time is of the essence in this Contract, and the time of Completion for the Work (“the Contract Time”) shall be ninety (90) calendar days which shall start to run on (a) the date of commencement of the Work as established in the Owner’s Notice to Proceed, or (b) if no date of commencement is established in a Notice to Proceed from Owner, the date of Contractor’s actual commencement of the Work (including mobilization). The Owner anticipates that the Contract Time will start to run on **January 25, 2024**, in which case the deadline for Completion would be **April 23, 2024**.

The site for the Contract will not be available to the Contractor for construction on the following dates: N/A. The Contractor shall not be entitled to time extensions for lack of access to the site on these dates.

Failure to Complete the Work within the Contract Time and in the manner provided for by the Contract Documents, or failure to complete any specified portion of the Work by a milestone deadline, shall subject the Contractor to liquidated damages. The actual occurrence of damages and the actual amount of the damages which the Owner would suffer if the Work were not Completed within the Contract Time, or if any specified portion of the Work were not completed by a milestone deadline, are dependent upon many circumstances and conditions which could prevail in various combinations and, from the nature of the case, it is impracticable and extremely difficult to fix the actual damages. Damages which the Owner would suffer in the event of such delay include, but are not limited to, loss of the use of the Work, disruption of activities, costs of administration and supervision, third party claims, and the incalculable inconvenience and loss suffered by the public.

Accordingly, the parties agree that \$1,000.00 per calendar day of delay shall be the damages which the Owner shall directly incur upon failure of the Contractor to Complete the Work within the Contract Time or Complete any specified portion of the Work by a milestone deadline, as described above. Liquidated damages will accrue for failure to meet milestone deadlines even if the Contractor Completes the Work within the Contract Time.

In addition, Contractor shall be subject to liquidated damages, or actual damages if liquidated damages are not recoverable under law, for causing another contractor on the Project to fail to timely complete its work under its contract or for causing delayed *completion* of the Project. The actual occurrence of damages and the actual amount of the damages which the Owner would suffer if another contractor on the Project were to fail to timely complete its work under its contract or delay *completion of the Project are dependent upon many circumstances and conditions which could prevail in various combinations and, from the nature of the case, it is impracticable and extremely difficult to fix the actual damages*. Damages which the Owner would suffer in the event of such delay include, but are not limited to, loss of the use of the Work, loss of use of the other contractor’s work, loss of use of the Project, disruption of activities, costs of administration and supervision, third party claims, the incalculable inconvenience and loss suffered by the public, and an Owner’s inability to recover its delay damages from the contractors whose work was delayed by Contractor.

Accordingly, the parties agree that \$1,000.00 for each calendar day of delay shall be the amount of damages which the Owner shall directly incur upon Contractor causing another contractor on the Project to fail to timely complete its work under its contract or causing delayed *completion* of the Project.

For Contractor's obligations regarding claims against Owner from other contractors on the Project alleging that Contractor caused delays to their work, see General Conditions sections 3.7.4, 3.16 and 6.2.3.

If liquidated damages accrue as described above, the Owner, in addition to all other remedies provided by law, shall have the right to assess the liquidated damages at any time, and to withhold liquidated damages (and any interest thereon) at any time from any and all retention or progress payments, which would otherwise be or become due the Contractor. In addition, if it is reasonably apparent to the Owner before liquidated damages begin to accrue that they will accrue, Owner may assess and withhold, from retention or progress payments, the estimated amount of liquidated damages that will accrue in the future. If the retained percentage or withheld progress payments are not sufficient to discharge all liabilities of the Contractor incurred under this Article, the Contractor and its sureties shall continue to remain liable to the Owner until all such liabilities are satisfied in full.

If Owner accepts any work or makes any payment under the Contract Documents after a default by reason of delays, the payment or payments shall in no respect constitute a waiver or modification of any provision in the Contract Documents regarding time of Completion, milestone deadlines, or liquidated damages.

#### **ARTICLE IV. PAYMENT AND RETENTION.**

The Owner agrees to pay the Contractor in current funds **ONE HUNDRED NINETEEN THOUSAND DOLLARS NO/100 (\$119,000.00)** for work satisfactorily performed after receipt of properly documented and submitted Applications for Payment and to make payments on account thereof, as provided in the General Conditions.

The above contract price does not include any special allowances. The above contract price includes a general contingency allowance of **FOURTEEN THOUSAND DOLLARS NO/100 (\$14,000.00)** to pay any additional amounts to which the Contractor may be entitled under the Contract Documents other than special allowances.

Any payment from a special allowance or general contingency allowance ("Allowance") is entirely at the discretion, and only with the advanced written approval, of the Owner. To request payment from an Allowance, the Contractor must fully comply with the Contract Documents' requirements related to Notice to Potential Changes, Change Order Requests, and Claims, including but not limited to Articles 4 and 7 of the General Conditions and its provisions regarding waiver of rights for failure to comply. If the Owner approves in writing a payment from an Allowance, no change order approved by Owner's governing body shall be required, but Contractor must sign an

Allowance expenditure form, after which the Contractor may include a request for such payment in its next progress payment application. Contractor's inclusion of a request for such payment in a progress payment application, or Contractor's acceptance of a progress payment that includes such payment, shall act as a full and complete waiver by Contractor of all rights to recover additional money related to the underlying basis of such payment; and such waiver shall be in addition to any other waiver that applies under the Contract Documents (including Article 4 of the General Conditions). If Contractor requests a time extension or other consideration in connection with or related to a requested payment from an Allowance, Contractor must comply with the Contract Documents' requirements related to Notice to Potential Changes, Change Order Requests, and Claims, including but not limited to Articles 4, 7, and 8 of the General Conditions and their provisions regarding waiver of rights for failure to comply, and no such time extension or other consideration may be issued until a change order is approved by the Owner's governing body pursuant to the Contract Documents. The amount of an Allowance may only be increased by a change order approved by Owner's governing body. Once an Allowance is fully spent, the Contractor must request any additional compensation pursuant to the procedures in the Contract Documents for Notices of Potential Claim, Change Order Requests, and Claims, and payment must be made by a change order approved by the Owner's governing body pursuant to the General Conditions. Upon Completion of the Work, all amounts in an Allowance that remain unspent and unencumbered shall remain the property of the Owner, Contractor shall have no claim to such funds, the Owner shall be entitled to a credit for such unused amounts against the above contract price, and the Owner may withhold such credit from any progress payment or release of retention.

#### **ARTICLE V. CHANGES.**

Changes in this Agreement or in the Work to be done under this Agreement shall be made as provided in the General Conditions.

#### **ARTICLE VI. TERMINATION.**

The Owner or Contractor may terminate the Contract as provided in the General Conditions.

#### **ARTICLE VII. PREVAILING WAGES.**

The Project is a public work, the Work shall be performed as a public work and pursuant to the provisions of Section 1770 et seq. of the Labor Code of the State of California, which are hereby incorporated by reference and made a part hereof, the Director of Industrial Relations has determined the general prevailing rate of per diem wages and the general prevailing rate for holiday and overtime work in the locality in which the Work is to be performed, for each craft, classification or type of worker needed to execute this Contract. Per diem wages shall be deemed to include employer payments for health and welfare, pension, vacation, apprenticeship or other training programs, and similar purposes. Copies of the rates are on file at the Owner's principal office. The rate of prevailing wage for any craft, classification or type of workmanship to be employed on this Project is the rate established by the applicable collective bargaining agreement which rate so provided is



hereby adopted by reference and shall be effective for the life of this Agreement or until the Director of the Department of Industrial Relations determines that another rate be adopted. It shall be mandatory upon the Contractor and on any subcontractor to pay not less than the said specified rates to all workers employed in the execution of this Agreement.

The Contractor and any subcontractor under the Contractor as a penalty to the Owner shall forfeit not more than Two Hundred Dollars (\$200.00) for each calendar day or portion thereof for each worker paid less than the stipulated prevailing rates for such work or craft in which such worker is employed. The difference between such stipulated prevailing wage rates and the amount paid to each worker for each calendar day or portion thereof for which each worker was paid less than the stipulated prevailing wage rate shall be paid to each worker by the Contractor.

The Contractor and each Subcontractor shall keep or cause to be kept an accurate record for Work on this Contract and Project showing the names, addresses, social security numbers, work classification, straight time and overtime hours worked and occupations of all laborers, workers and mechanics employed by them in connection with the performance of this Contract or any subcontract thereunder, and showing also the actual per diem wage paid to each of such workers, which records shall be open at all reasonable hours to inspection by the Owner, its officers and agents and to the representatives of the Division of Labor Standards Enforcement of the State Department of Industrial Relations. The Contractor and each subcontractor shall furnish a certified copy of all payroll records directly to the Labor Commissioner.

Public works projects shall be subject to compliance monitoring and enforcement by the Department of Industrial Relations. For all projects over Twenty-Five Thousand Dollars (\$25,000), a contractor or subcontractor shall not be qualified to submit a bid or to be listed in a bid proposal subject to the requirements of Public Contract Code section 4104 unless currently registered and qualified under Labor Code section 1725.5 to perform public work as defined by Division 2, Part 7, Chapter 1 (§§1720 et seq.) of the Labor Code. For all projects over Twenty-Five Thousand Dollars (\$25,000), a contractor or subcontractor shall not be qualified to enter into, or engage in the performance of, any contract of public work (as defined by Division 2, Part 7, Chapter 1 (§§1720 et seq.) of the Labor Code) unless currently registered and qualified under Labor Code section 1725.5 to perform public work.

#### **ARTICLE VIII. WORKING HOURS.**

In accordance with the provisions of Sections 1810 to 1815, inclusive, of the Labor Code of the State of California, which are hereby incorporated and made a part hereof, the time of service of any worker employed by the Contractor or a Subcontractor doing or contracting to do any part of the Work contemplated by this Agreement is limited and restricted to eight hours during any one calendar day and forty hours during any one calendar week, provided, that work may be performed by such employee in excess of said eight hours per day or forty hours per week provided that compensation for all hours worked in excess of eight hours per day, and forty hours per week, is paid at a rate not less than one and one-half (1½) times the basic rate of pay. The Contractor and every Subcontractor

shall keep an accurate record showing the name of and the actual hours worked each calendar day and each calendar week by each worker employed by them in connection with the Work. The records shall be kept open at all reasonable hours to inspection by representatives of the Owner and the Division of Labor Law Enforcement. The Contractor shall as a penalty to the Owner forfeit Twenty-five Dollars (\$25.00) for each worker employed in the execution of this Agreement by the Contractor or by any subcontractor for each calendar day during which such worker is required or permitted to work more than eight hours in any one calendar day, and forty hours in any one calendar week, except as herein provided.

#### **ARTICLE IX. APPRENTICES.**

The Contractor agrees to comply with Chapter 1, Part 7, Division 2, Sections 1777.5 and 1777.6 of the California Labor Code, which are hereby incorporated and made a part hereof. These sections require that contractors and subcontractors employ apprentices in apprenticeable occupations in a ratio of not less than one hour of apprentice's work for each five hours of work performed by a journeyman (unless an exemption is granted in accordance with Section 1777.5) and that contractors and subcontractors shall not discriminate among otherwise qualified employees as indentured apprentices on any public works solely on the ground of sex, race, religious creed, national origin, ancestry or color. Only apprentices as defined in Labor Code Section 3077, who are in training under apprenticeship standards and who have signed written apprentice agreements, will be employed on public works in apprenticeable occupations. The responsibility for compliance with these provisions is fixed with the Contractor for all apprenticeable occupations.

#### **ARTICLE X. DSA OVERSIGHT PROCESS.**

The Contractor must comply with the applicable requirements of the Division of State Architect ("DSA") Construction Oversight Process ("DSA Oversight Process"), including but not limited to (a) notifying the Owner's Inspector of Record/Project Inspector ("IOR") upon commencement and completion of each aspect of the Work as required under DSA Form 156; (b) coordinating the Work with the IOR's inspection duties and requirements; (c) submitting verified reports under DSA Form 6-C; and (d) coordinating with the Owner, Owner's Architect, any Construction Manager, any laboratories, and the IOR to meet the DSA Oversight Process requirements without delay or added costs to the Work or Project.

*Contractor shall be responsible for any additional DSA fees related to review of proposed changes to the DSA-approved construction documents, to the extent the proposed changes were caused by Contractor's wrongful act or omissions. If inspected Work is found to be in non-compliance with the DSA-approved construction documents or the DSA-approved testing and inspection program, then it must be removed and corrected. Any construction that covers unapproved or uninspected Work is subject to removal and correction, at Contractor's expense, in order to permit inspection and approval of the covered work in accordance with the DSA Oversight Process.*

## **ARTICLE XI. INDEMNIFICATION AND INSURANCE.**

The Contractor will defend, indemnify and hold harmless the Owner, its governing board, officers, agents, trustees, employees and others as provided in the General Conditions.

By this statement the Contractor represents that it has secured the payment of Workers' Compensation in compliance with the provisions of the Labor Code of the State of California and during the performance of the work contemplated herein will continue so to comply with said provisions of said Code. The Contractor shall supply the Owner with certificates of insurance evidencing that Workers' Compensation Insurance is in effect and providing that the Owner will receive thirty (30) days' notice of cancellation.

Contractor shall provide the insurance set forth in the General Conditions. The amount of general liability insurance shall be \$2,000,000 per occurrence for bodily injury, personal injury and property damage and the amount of automobile liability insurance shall be \$1,000,000 per accident for bodily injury and property damage combined single limit.

## **ARTICLE XII. ENTIRE AGREEMENT.**

The Contract constitutes the entire agreement between the parties relating to the Work, and supersedes any prior or contemporaneous agreement between the parties, oral or written, including the Owner's award of the Contract to Contractor, unless such agreement is expressly incorporated herein. The Owner makes no representations or warranties, express or implied, not specified in the Contract. The Contract is intended as the complete and exclusive statement of the parties' agreement pursuant to Code of Civil Procedure section 1856.

## **ARTICLE XIII. EXECUTION OF OTHER DOCUMENTS.**

The parties to this Agreement shall cooperate fully in the execution of any and all other documents and in the completion of any additional actions that may be necessary or appropriate to give full force and effect to the terms and intent of the Contract.

## **ARTICLE XIV. EXECUTION IN COUNTERPARTS.**

This Agreement may be executed in counterparts such that the signatures may appear on separate signature pages. A copy, or an original, with all signatures appended together, shall be deemed a fully executed Agreement.

## **ARTICLE XV. BINDING EFFECT.**

Contractor, by execution of this Agreement, acknowledges that Contractor has read this Agreement and the other Contract Documents, understands them, and agrees to be bound by their terms and conditions. The Contract shall inure to the benefit of and shall be binding upon the

Contractor and the Owner and their respective successors and assigns.

**ARTICLE XVI. SEVERABILITY; GOVERNING LAW; CHOICE OF FORUM.**

If any provision of the Contract shall be held invalid or unenforceable by a court of competent jurisdiction, such holding shall not invalidate or render unenforceable any other provision hereof. The Contract shall be governed by the laws of the State of California. Any action or proceeding seeking any relief under or with respect to this Agreement shall be brought solely in the Superior Court of the State of California for the County of Alameda, subject to transfer of venue under applicable State law, provided that nothing in this Agreement shall constitute a waiver of immunity to suit by Owner.

**ARTICLE XVII. AMENDMENTS.**

The terms of the Contract shall not be waived, altered, modified, supplemented or amended in any manner whatsoever except by written agreement, including a change order, signed by the parties and approved or ratified by the Governing Board.

**ARTICLE XVIII. ASSIGNMENT OF CONTRACT.**

The Contractor shall not assign or transfer by operation of law or otherwise any or all of its rights, burdens, duties or obligations without the prior written consent of the surety on the payment bond, the surety on the performance bond and the Owner.

**ARTICLE XIX. WRITTEN NOTICE.**

Written notice shall be deemed to have been duly served if delivered in person to the individual or member of the firm or to an officer of the corporation for whom it was intended, or if delivered at or sent by registered or certified or overnight mail to the last business address known to the person who gives the notice.

**ARTICLE XX. SANCTIONS IN RESPONSE TO RUSSIAN AGGRESSION**

The Owner requires Contractor to comply with the Governor's March 4, 2022, Executive Order N-6-22 ("Order") relating to any existing sanctions imposed by the United States government and the State of California in response to Russia's actions in Ukraine, including additional requirements for contracts of \$5 million or more. *Failure to comply may result in the termination of the Contract.*

**CONTRACTOR:  
DATA MEDIA SERVICES, INC.**

Signature:  \_\_\_\_\_

Name: Christopher Koayer Date: 12/21/2023

(Chairman, Pres., or Vice-Pres. \_\_\_\_\_)

Signature [Signature]  
Name: Christopher Koayer Date: 12/21/2023

(Secretary, Asst. Secretary, CFO, or Asst. Treasure) \_\_\_\_\_

**OAKLAND UNIFIED SCHOOL DISTRICT**

[Signature] 1/25/2024  
\_\_\_\_\_  
Benjamin "Sam" Davis, President, Board of Education Date

[Signature] 1/25/2024  
\_\_\_\_\_  
Kyla Johnson-Trammell, Superintendent and Secretary, Board of Education Date

[Signature] Dec 27, 2023  
\_\_\_\_\_  
[Preston Thomas \(Dec 27, 2023 16:11 PST\)](#) Date  
Preston Thomas, Chief Systems & Services Officer  
Facilities Planning and Management

**Approved As To Form:**

\_\_\_\_\_  
OUSD Facilities Legal Counsel Date

1055604  
CALIFORNIA CONTRACTOR'S  
LICENSE NO.  
07/08/2025  
LICENSE EXPIRATION DATE

**NOTE:** Contractor must give the full business address of the Contractor and sign with Contractor's usual signature. Partnerships must furnish the full name of all partners and the Agreement must be signed in the partnership name by a general partner with authority to bind the partnership in such matters, followed by the signature and designation of the person signing. The name of the person signing shall also be typed or printed below the signature. Corporations must sign with the legal name of the corporation, followed by the name of the state of incorporation and by the signature

Name: \_\_\_\_\_ Date: \_\_\_\_\_

(Chairman, Pres., or Vice-Pres. \_\_\_\_\_)

Signature \_\_\_\_\_

Name: \_\_\_\_\_ Date: \_\_\_\_\_

(Secretary, Asst. Secretary, CFO, or Asst. Treasure) \_\_\_\_\_

**OAKLAND UNIFIED SCHOOL DISTRICT**

\_\_\_\_\_  
**Mike Hutchinson, President, Board of Education** Date \_\_\_\_\_

\_\_\_\_\_  
**Kyla Johnson-Trammell, Superintendent and Secretary, Board of Education** Date \_\_\_\_\_

\_\_\_\_\_  
**Preston Thomas, Chief Systems & Services Officer Facilities Planning and Management** Date \_\_\_\_\_

**Approved As To Form:**

  
\_\_\_\_\_  
**OUSD Facilities Legal Counsel** **12/27/23**  
**Date**

\_\_\_\_\_  
CALIFORNIA CONTRACTOR'S  
LICENSE NO.

\_\_\_\_\_  
LICENSE EXPIRATION DATE

**NOTE:** Contractor must give the full business address of the Contractor and sign with Contractor's usual signature. Partnerships must furnish the full name of all partners and the Agreement must be signed in the partnership name by a general partner with authority to bind the partnership in such matters, followed by the signature and designation of the person signing. The name of the person signing shall also be typed or printed below the signature. Corporations must sign with the legal name of the corporation, followed by the name of the state of incorporation and by the signature

and designation of the chairman of the board, president or any vice president, and then followed by a second signature by the secretary, assistant secretary, the chief financial officer or assistant treasurer. All persons signing must be authorized to bind the corporation in the matter. The name of each person signing shall also be typed or printed below the signature. Satisfactory evidence of the authority of the officer signing on behalf of a corporation shall be furnished.



PO Box 5077 Sioux Falls SD 57117-5077

1-800-331-6053  
Fax 1-605-335-0357  
www.cnasurety.com  
uwservices@cnasurety.com

DATE: December 13th, 2023

AGENT CODE: 04 23075

ATTENTION: Anthony Gallo

Number of Pages: 7

RE: Bond 72607673 - Data Media Services, Inc.

Various Sites - Door Entry Systems Group 6 Project No 23127

Contract Amount: \$ 119,000.00

Company Code: 0601

Thank you for placing this business with CNA Surety.

Please execute the requested bond(s) by using the following documents sent with this fax/email. Sign the bond(s) and attach a gold colored seal from your Western Surety Company bond kit to each bond issued.

Premium: \$1,785.00

Commission Percentage: 30.0

Effective: December 13th, 2023

\*\*\*Please reference the CNA Surety web site [www.cnasurety.com](http://www.cnasurety.com) for easy access to our Fast Track Application.

Please check your supply of gold seals periodically to ensure you have an adequate amount. To reorder gold seals, simply visit [cnasurety.com](http://cnasurety.com) and click on the "Order Supplies Here" icon under the Broker/Agent Services section.

Business Services





PO Box 5077 Sioux Falls SD 57117-5077

1-800-331-6053  
Fax 1-605-335-0357  
www.cnasurety.com  
uwservices@cnasurety.com

DATE: December 13th, 2023

AGENT CODE: 04 23075

ATTENTION: Anthony Gallo

Number of Pages: 7

RE: Bond 72607673 - Data Media Services, Inc.

Various Sites - Door Entry Systems Group 6 Project No 23127

Contract Amount: \$ 119,000.00

Company Code: 0601

Thank you for placing this business with CNA Surety.

Please execute the requested bond(s) by using the following documents sent with this fax/email. Sign the bond(s) and attach a gold colored seal from your Western Surety Company bond kit to each bond issued.

Premium: \$1,785.00

Commission Percentage: 30.0

Effective: December 13th, 2023

\*\*\*Please reference the CNA Surety web site [www.cnasurety.com](http://www.cnasurety.com) for easy access to our Fast Track Application.

Please check your supply of gold seals periodically to ensure you have an adequate amount. To reorder gold seals, simply visit [cnasurety.com](http://cnasurety.com) and click on the "Order Supplies Here" icon under the Broker/Agent Services section.

Business Services

**PERFORMANCE BOND**  
**DOCUMENT 00 61 00**

Bond Number: 72607673

**KNOW ALL MEN BY THESE PRESENTS** that we, Data Media Services, Inc., as Principal, and WESTERN SURETY COMPANY, as Surety, are held and firmly bound unto the Oakland Unified School District, in the County of Alameda, State of California, hereinafter called the "Owner," in the sum of One Hundred Nineteen Thousand and 00/100 Dollars (\$ 119,000.00 ) for the payment of which sum well and truly made, we bind ourselves, our heirs, executors, administrators, and successors, jointly and severally, to the Owner for the full performance of a certain contract with the Owner, the terms of which are incorporated herein by reference, dated **January 25, 2024**, for construction of

**the Various Sites Door Entry Systems Group 6 Project No 23127, (the "Contract").** The Scope of work for Group 6 includes: Installation of iPhone door entry intercom systems at various sites. Sites: Thornhill Elementary School, Oakland Academy of Knowledge, Lockwood Steam Academy, Lockwood CDC, & Kaiser Early Childhood Center.

The condition of this obligation is such that, if the Principal shall well and truly perform and fulfill all the undertakings, covenants, terms, conditions, and agreements of said Contract during the original term of said Contract and any extensions thereof that may be granted by the Owner, with or without notice to the Surety, and for the period of time specified in the Contract after completion for correction of faulty or improper materials and workmanship and during the life of any guaranty or warranty required under the Contract, and shall also well and truly perform and fulfill all the undertakings, covenants, terms, conditions and agreement of any and all duly authorized modifications of said Contract that may hereafter be made, then this obligation is to be void, otherwise to remain in full force and virtue.

And the said Surety, for value received, hereby stipulates and agrees that no change, extension of time, alteration or addition to the terms of the Contract or to the Work to be performed thereunder or the specifications accompanying the same, shall in any way affect its obligation on this bond, and it does hereby waive notice of any such change, extension of time, alteration or addition to the terms of the Contract, or to the Work, or to the specifications.

No further agreement between Surety and Owner shall be required as a prerequisite to the Surety performing its obligations under this bond. In the event that the Surety elects to complete the Work of the Contract after termination of the Contract by Owner, the Surety may not hire Principal, or any of Principal's owners, employees, or subcontractors, to perform the Work without the written consent of Owner, and the Owner may grant or withhold such consent within its sole discretion.

{SR798942} 1

OAKLAND UNIFIED SCHOOL DISTRICT  
VARIOUS SITES  
DOOR ENTRY SYSTEMS GROUP 6  
PROJECT NO.:23127

PERFORMANCE BOND  
DOCUMENT 00 61 00

IN WITNESS WHEREOF, the above-bounden parties have executed this instrument under their several seals this 13th day of December, 2023, hereto affixed and these presents duly signed by its undersigned representative, pursuant to authority of its governing body.

(To be signed by )  
(Principal and Surety, )  
(and acknowledged and )  
(Notarial Seal attached )

(Affix Corporate Seal)

\_\_\_\_\_  
(Individual Principal)

\_\_\_\_\_  
(Business Address)

(Affix Corporate Seal)

\_\_\_\_\_  
(Corporate Principal)

\_\_\_\_\_  
(Business Address)

(Affix Corporate Seal)

WESTERN SURETY COMPANY  
\_\_\_\_\_  
(Corporate Surety)

151 N. Franklin, 17th Floor, Chicago, IL 60606  
\_\_\_\_\_  
(Business Address)

By: Mauricio Alejandro Garcia  
\_\_\_\_\_  
Attorney-in-Fact

The rate of premium on this bond is \$15.00 per thousand.

The total amount of premium charged is \$1,785.00.

The above must be filled in by Corporate Surety.

{SR798942}2

OAKLAND UNIFIED SCHOOL DISTRICT  
VARIOUS SITES  
DOOR ENTRY SYSTEMS GROUP 6  
PROJECT NO.:23127

PERFORMANCE BOND  
DOCUMENT 00 61 00

**IN WITNESS WHEREOF**, the above-bounden parties have executed this instrument under their several seals this \_\_\_\_\_ day of \_\_\_\_\_, 20\_\_, hereto affixed and these presents duly signed by its undersigned representative, pursuant to authority of its governing body.

(To be signed by \_\_\_\_\_ )  
(Principal and Surety, \_\_\_\_\_ )  
(and acknowledged and \_\_\_\_\_ )  
(Notarial Seal attached \_\_\_\_\_ )

(Affix Corporate Seal)



\_\_\_\_\_  
(Individual Principal)

668 QUEENSLAND CIR. STOCKTON  
CA 95204  
\_\_\_\_\_  
(Business Address)

(Affix Corporate Seal)

\_\_\_\_\_  
(Corporate Principal)

\_\_\_\_\_  
(Business Address)

(Affix Corporate Seal)

\_\_\_\_\_  
(Corporate Surety)

\_\_\_\_\_  
(Business Address)

By: \_\_\_\_\_  
\_\_\_\_\_

The rate of premium on this bond is \_\_\_\_\_ per thousand.

The total amount of premium charged is \_\_\_\_\_.

The above must be filled in by Corporate Surety.

{SR798942} 2

**PAYMENT BOND**  
**DOCUMENT 00 61 01**  
**(Labor and Material)**

Bond Number: 72607673

**KNOW ALL MEN BY THESE PRESENTS:**

That WHEREAS, the Oakland Unified School District (the "Owner" of the public works contract described below) and Data Media Services, Inc., hereinafter designated as the "Principal," have entered into a Contract for the furnishing of all materials and labor, services and transportation, necessary, convenient, and proper to construct

**the Various Sites Door Entry Systems Group 6 Project 23127**, The Scope of work for Group 6 includes: Installation of AIPhone door entry intercom systems at various sites. Sites: Thornhill Elementary School, Oakland Academy of Knowledge, Lockwood Steam Academy, Lockwood CDC, & Kaiser Early Childhood Center.

which said agreement dated **January 25, 2024**, and all of the Contract Documents are hereby referred to and made a part hereof;

and

WHEREAS, the Principal is required, before entering upon the performance of the work, to file a good and sufficient bond with the body by whom the Contract is awarded to secure the claims arising under said agreement.

**NOW, THEREFORE, THESE PRESENTS WITNESSETH:**

That the said Principal and the undersigned WESTERN SURETY COMPANY ("Surety") are held and firmly bound unto all laborers, material men, and other persons, and bound for all amounts due, referred to in Civil Code section 9554, subdivision (b), in the sum of One Hundred Nineteen Thousand and 00/100 Dollars (\$ 119,000.00) which sum well and truly be made, we bind ourselves, our heirs, executors, administrators, successors, or assigns, jointly and severally, by these presents.

The condition of this obligation is that if the said Principal or any of its subcontractors, or the heirs, executors, administrators, successors, or assigns of any, all, or either of them, shall fail to pay any of the persons named in Civil Code section 9100, or any of the amounts due, as specified in Civil Code section 9554, subdivision (b), that said Surety will pay the same in an amount not exceeding the amount hereinabove set forth, and also in case suit is brought upon this bond, will pay costs and reasonable attorney's fees to be

{SR798938} 1

OAKLAND UNIFIED SCHOOL DISTRICT  
VARIOUS SITES  
DOOR ENTRY SYSTEMS GROUP 6  
PROJECT NO.:23127

PAYMENT BOND  
DOCUMENT 00 61 01

awarded and fixed by the Court, and to be taxed as costs and to be included in the judgment therein rendered.

It is hereby expressly stipulated and agreed that this bond shall inure to the benefit of any and all persons, companies, and corporations entitled to file claims so as to give a right of action to them or their assigns in any suit brought upon this bond.

Should the condition of this bond be fully performed, then this obligation shall become null and void, otherwise it shall be and remain in full force and effect.

And the said Surety, for value received, thereby stipulates and agrees that no change, extension of time, alteration, or addition to the terms of said contract or the specifications accompanying the same shall in any manner affect its obligations on this bond, and it does hereby waive notice of any such change, extension, alteration, or addition.

IN WITNESS WHEREOF, this instrument has been duly executed by the Principal and Surety this 13th day of December, 2023.

(To be signed by )  
(Principal and Surety, )  
(and acknowledged and )  
(Notarial Seal attached )

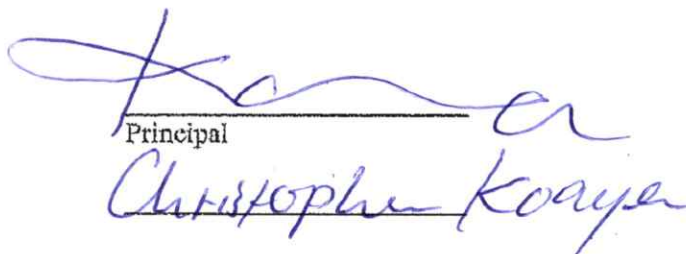
  
Principal

WESTERN SURETY COMPANY  
Surety

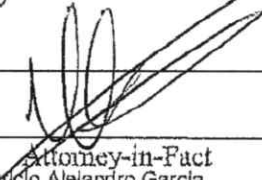
By:   
Attorney-in-Fact  
Mauricio Alejandro Garcia

The above bond is accepted and approved this 14th day of December.

{SR798938}2

OAKLAND UNIFIED SCHOOL DISTRICT  
VARIOUS SITES  
DOOR ENTRY SYSTEMS GROUP 6  
PROJECT NO.: 23127

PAYMENT BOND  
DOCUMENT 00 61 01

Acknowledgment of Principal

Acknowledgment of Surety (Attorney-in-Fact)

A notary public or other officer completing this certificate verifies only the identity of the individual who signed the document to which this certificate is attached, and not the truthfulness, accuracy, or validity of that document.

STATE OF California }  
COUNTY OF Orange } ss

On December 13th, 2023 before me, \_\_\_\_\_, here insert name and title of the officer  
date  
personally appeared Mauricio Alejandro Garcia,  
name(s) of signer(s)

who proved to me on the basis of satisfactory evidence to be the person(s) whose name(s) is/are subscribed to the within instrument and acknowledged to me that he/she/they executed the same in his/her/their authorized capacity(ies), and that by his/her/their signature(s) on the instrument the person(s), or the entity upon behalf of which the person(s) acted, executed the instrument.

I certify under PENALTY OF PERJURY under the laws of the State of California that the foregoing paragraph is true and correct.

WITNESS my hand and official seal.

Signature \_\_\_\_\_ (Seal) 12/14/2023

(The balance of this page is intentionally left blank.)



# Western Surety Company

## POWER OF ATTORNEY - CERTIFIED COPY

Bond No. 72607673

Know All Men By These Presents, that WESTERN SURETY COMPANY, a corporation duly organized and existing under the laws of the State of South Dakota, and having its principal office in Sioux Falls, South Dakota (the "Company"), does by these presents make, constitute and appoint Mauricio Alejandro Garcia

its true and lawful attorney(s)-in-fact, with full power and authority hereby conferred, to execute, acknowledge and deliver for and on its behalf as Surety, bonds for:

Principal: Data Media Services, Inc.  
Obligee: Oakland Unified School District  
Amount: \$1,000,000.00

and to bind the Company thereby as fully and to the same extent as if such bonds were signed by the Vice President, sealed with the corporate seal of the Company and duly attested by its Secretary, hereby ratifying and confirming all that the said attorney(s)-in-fact may do within the above stated limitations. Said appointment is made under and by authority of the following bylaw of Western Surety Company which remains in full force and effect.

"Section 7. All bonds, policies, undertakings, Powers of Attorney or other obligations of the corporation shall be executed in the corporate name of the Company by the President, Secretary, any Assistant Secretary, Treasurer, or any Vice President or by such other officers as the Board of Directors may authorize. The President, any Vice President, Secretary, any Assistant Secretary, or the Treasurer may appoint Attorneys in Fact or agents who shall have authority to issue bonds, policies, or undertakings in the name of the Company. The corporate seal is not necessary for the validity of any bonds, policies, undertakings, Powers of Attorney or other obligations of the corporation. The signature of any such officer and the corporate seal may be printed by facsimile."

This Power of Attorney may be signed by digital signature and sealed by a digital or otherwise electronic-formatted corporate seal under and by the authority of the following Resolution adopted by the Board of Directors of the Company by unanimous written consent dated the 27th day of April, 2022:

"RESOLVED: That it is in the best interest of the Company to periodically ratify and confirm any corporate documents signed by digital signatures and to ratify and confirm the use of a digital or otherwise electronic-formatted corporate seal, each to be considered the act and deed of the Company."

If Bond No. 72607673 is not issued on or before midnight of April 20th, 2024, all authority conferred in this Power of Attorney shall expire and terminate.

In Witness Whereof, Western Surety Company has caused these presents to be signed by its Vice President, Larry Kasten, and its corporate seal to be affixed this 13th day of December, 2023.

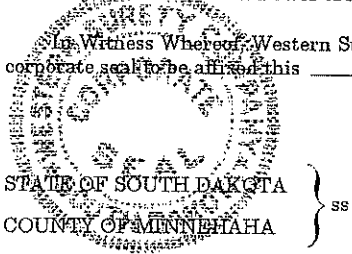

WESTERN SURETY COMPANY

Larry Kasten  
Larry Kasten, Vice President

On this 13th day of December, in the year 2023, before me, a notary public, personally appeared Larry Kasten, who being to me duly sworn, acknowledged that he signed the above Power of Attorney as the aforesaid officer of WESTERN SURETY COMPANY and acknowledged said instrument to be the voluntary act and deed of said corporation.

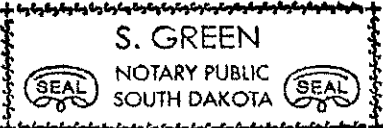

S. Green  
Notary Public - South Dakota  
My Commission Expires February 12, 2027

I the undersigned officer of Western Surety Company, a stock corporation of the State of South Dakota, do hereby certify that the attached Power of Attorney is in full force and effect and is irrevocable, and furthermore, that Section 7 of the bylaws of the Company as set forth in the Power of Attorney is now in force.

In testimony whereof, I have hereunto set my hand and seal of Western Surety Company this 13th day of December, 2023.

WESTERN SURETY COMPANY

Larry Kasten  
Larry Kasten, Vice President





Oakland Unified School District  
Division of Facilities Planning and Management

**BID OPENING TABULATION SHEET**

School: Various Sites  
 Project: Door Entry Systems Group 6  
 Project #: 23127  
 Estimate: \$140,000

Date: Tuesday, November 28, 2023  
 Time: 2:00 P.M.  
 Project Mgr: Kyle Brower  
 Architect: N/A

Signature of Witness to Bid 

Signature of Bid Opener 

<b>Company:</b>	Data Media Services, Inc.	<b>Base Bid:</b>	\$105,000.00	<b>Required Day of Bid:</b>	
<b>Address:</b>	562 14th Street,	<b>Allowance:</b>	\$14,000.00	Signed Bid Form	x
<b>City/State:</b>	Oakland, CA 94612	<b>TOTAL:</b>	\$119,000.00	Addendum Acknow.	x
<b>Phone:</b>	(209) 688-1385	<b>Alternates:</b>		Bid Bond	x
<b>Fax:</b>	(209) 688-1385			Non-Collusion	x
				Iran Contracting Certification	NA
		<u>Time Submitted</u>	<u>Date Submitted</u>	Site Visit Certification	x
		2pm	11/28/2023	Contractor's Sub List	x
				Debarment Suspension & Schd Z	x
		<u>Time Opened</u>	<u>Date Opened</u>	Local Business Participation Form	x
		2:35 PM	11/28/2023	DVBE Forms	x
<b>Company:</b>		<b>Base Bid:</b>		<b>Required Day of Bid:</b>	
<b>Address:</b>		<b>Allowance:</b>	\$14,000.00	Signed Bid Form	
<b>City/State:</b>		<b>TOTAL:</b>		Addendum Acknow.	
<b>Phone:</b>		<b>Alternates:</b>		Bid Bond	
<b>Fax:</b>				Non-Collusion	
				Iran Contracting Certification	NA
		<u>Time Submitted</u>	<u>Date Submitted</u>	Site Visit Certification	
				Contractor's Sub List	
				Debarment Suspension & Schd Z	
		<u>Time Opened</u>	<u>Date Opened</u>	Local Business Participation Form	WA
				DVBE Forms	
<b>Company:</b>		<b>Base Bid:</b>		<b>Required Day of Bid:</b>	
<b>Address:</b>		<b>Allowance:</b>	\$14,000.00	Signed Bid Form	
<b>City/State:</b>		<b>TOTAL:</b>		Addendum Acknow.	
<b>Phone:</b>		<b>Alternates:</b>		Bid Bond	
<b>Fax:</b>				Non-Collusion	
				Iran Contracting Certification	NA
		<u>Time Submitted</u>	<u>Date Submitted</u>	Site Visit Certification	
				Contractor's Sub List	
				Debarment Suspension & Schd Z	
		<u>Time Opened</u>	<u>Date Opened</u>	Local Business Participation Form	WA
				DVBE Forms	
<b>Company:</b>		<b>Base Bid:</b>		<b>Required Day of Bid:</b>	
<b>Address:</b>		<b>Allowance:</b>	\$14,000.00	Signed Bid Form	
<b>City/State:</b>		<b>TOTAL:</b>		Addendum Acknow.	
<b>Phone:</b>		<b>Alternates:</b>		Bid Bond	
<b>Fax:</b>				Non-Collusion	
				Iran Contracting Certification	
		<u>Time Submitted</u>	<u>Date Submitted</u>	Site Visit Certification	
				Contractor's Sub List	
				Debarment Suspension & Schd Z	
		<u>Time Opened</u>	<u>Date Opened</u>	Local Business Participation Form	
				DVBE Forms	

BID FORM  
DOCUMENT 00 31 01

The Various Sites Door Entry Systems Group 5 & 6 Contracts at Multiple Sites for the  
Oakland Unified School District

OAKLAND UNIFIED SCHOOL DISTRICT

955 High Street, Front Office desk  
Oakland, CALIFORNIA 94601

Dear Board Members:

The undersigned, doing business under the firm name of DATA MEDIA SERVICES hereby proposes and agrees to enter into a contract, with the Oakland Unified School District ("Owner"), to furnish any and all labor, materials, applicable taxes, equipment and services for the completion of Work as described hereinafter and in the Contract Documents for the following contracts on which the undersigned submits bids:

- **Various Sites – Door Entry Systems Group 5 Project No 23126 (the “Group 5 Contract”)**. The scope of work of the Group 5 Contract includes Installation of AIPhone door entry intercom systems at various sites. Sites: Oakland Tech Upper Campus, Montera Middle School, Jefferson CDC, Hillcrest Elementary School, & Bella Vista CDC.
  
- **Various Sites– Door Entry Systems Group 6 Project No 23127 (the “Group 6 Contract”)**. The scope of work of the Group 6 Contract includes Installation of AIPhone door entry intercom systems at various sites. Sites: Thornhill Elementary School, Oakland Academy of Knowledge, Lockwood Steam Academy, Lockwood CDC, & Kaiser Early Childhood Center.

The Contract Documents for the Contracts were prepared by Oakland Unified School District, Oakland, California.

**Bid Amounts (Base Bids):**

The undersigned submits one or more bids on the Contracts, as follows:

**For the Group 5 Contract:**

OAKLAND UNIFIED SCHOOL DISTRICT  
VARIOUS SITES  
DOOR ENTRY SYSTEMS GROUP 5 & 6  
Project No: 23126 & 23127  
{SR806780}

BID FORM  
DOCUMENT 00 31 01

<p><u>ONE HUNDRED AND EIGHT THOUSAND</u> Dollars  <i>Bid Amount Without Contingency Allowance</i></p>	<p>\$ <u>108,000.00</u></p>
<p>Fifteen Thousand Dollars  <i>Total of Allowances (see Section IV of Agreement)</i></p>	<p>\$15,000.00</p>
<p><u>ONE HUNDRED AND TWENTY-THREE THOUSAND</u> Dollars  <i>Total Base Bid Amount</i></p>	<p>\$ <u>123,000</u></p>
<p><b>By submitting this bid, bidder acknowledges and agrees that the Total Base Bid Amount accounts for any and all allowances.</b></p>	

For the Group 6 Contract:

<p><u>ONE HUNDRED AND FIVE THOUSAND</u> Dollars  <i>Bid Amount Without Contingency Allowance</i></p>	<p>\$ <u>105,000.00</u></p>
<p>Fourteen Thousand Dollars  <i>Total of Allowances (see Section IV of Agreement)</i></p>	<p>\$14,000.00</p>
<p><u>ONE HUNDRED NINETEEN THOUSAND</u> Dollars  <i>Total Base Bid Amount</i></p>	<p>\$ <u>119,000.00</u></p>
<p><b>By submitting this bid, bidder acknowledges and agrees that the Total Base Bid Amount accounts for any and all allowances.</b></p>	

Miscellaneous:

For each Contract, the low bid shall be determined as described in the Notice to Bidders.

For each Contract awarded to the undersigned, the undersigned shall, within ten (10) days after mailing, faxing, or delivering of the Notice of Award or prior to the commencement of the Work, whichever is earlier, execute and deliver an agreement in the form of agreement present in these Contract Documents and give Performance and Payment Bonds in accordance with the specifications and bid as accepted.

The undersigned declares that it has read and understands the Contract Documents for each Contract on which it has submitted a bid, including but not limited to the Notice to Bidders, the Instructions to Bidders, the Agreement, the General Conditions, the Drawings, the Specifications, and any Special Conditions.

The undersigned declares that it has read and understands the Contract Documents, including but not limited to the Notice to Bidders, the Instructions to Bidders, the Agreement, the General Conditions, the Drawings, the Specifications, and any Special Conditions.

The undersigned hereby designates as the office to which any Notice of Award of a Contract may be mailed, faxed, or delivered:

668 QUEENSLAND CIR STOCKTON, CA 95206

Our Public Liability and Property Damage Insurance is placed with:

BIBERK

Our Workers' Compensation Insurance is placed with:

Circular letters, bulletins, addenda, etc., bound with the specifications or issued during the time of bidding are included in the undersigned's bid for each Contract, and, in Completing the Contract, they are to become a part thereof.

The receipt of the following addenda to the specifications is acknowledged:

Addendum No. <u>1</u>	Date <u>11/28/2023</u>	Addendum No. _____	Date _____
Addendum No. _____	Date _____	Addendum No. _____	Date _____
Addendum No. _____	Date _____	Addendum No. _____	Date _____

A bid for any Contract above may be withdrawn in writing at any time prior to the scheduled time for the opening of bids, including any authorized postponement thereof.

A bidder shall not submit this bid form unless the bidder's California contractor's license number appears clearly on it, the license expiration date and class are stated, and the bid form contains a statement that the representations made therein are made under penalty of perjury. Any bid submitted by a contractor who is not licensed pursuant to Business and Professions Code section 7028.15 shall be considered nonresponsive and shall be rejected. Any bid not containing the above information may be considered nonresponsive and may be rejected.

Proof of Bidder's registration per Labor Code §1725.5 must be submitted with this bid form.

**NOTE:** This bid form must give the full business address of the bidder and be signed by bidder with bidder's usual signature. Partnerships must furnish the full name of all partners and must be signed in the partnership name by a general partner with authority to bind the partnership in such matters, followed by the signature and designation of the person signing. The name of the person signing shall also be typed or printed below the signature. Corporations must sign with the legal name of the corporation, followed by the name of the state of incorporation and by the signature and designation of the chairman of the board, president or any vice president, and then followed by a second signature by the secretary, assistant secretary, the chief financial officer or assistant treasurer. All persons signing must be authorized to bind the corporation in the matter. The name of each person signing shall also be typed or printed below the signature. Satisfactory evidence of the authority of the officers signing on behalf of a corporation shall be furnished with the bid.

The undersigned declares under penalty of perjury under the laws of the State of California that the representations made in this bid are true and correct.

Name of Company as Licensed in California: DATA MEDIA SERVICES INC  
Business Address: 562 14th ST OAKLAND, CA, 94612  
Telephone Number: 209-688-1385  
California Contractor License No.: 1055604  
Class and Expiration Date: C-7 EXP 07-31-2024  
Public Works Contractor Registration No.: PW-LR-1000591508  
State of Incorporation, if Applicable: CA

INDIVIDUAL:

Dated: \_\_\_\_\_, 20\_\_

\_\_\_\_\_  
\_\_\_\_\_  
(Name)

PARTNERSHIP:

Evidence of authority to bind partnership is attached.

Dated: \_\_\_\_\_, 20\_\_

\_\_\_\_\_  
\_\_\_\_\_  
(Name)

General Partner

CORPORATION:

Evidence of authority to bind corporation is attached.

Dated: 11/28, 20 23

Christopher Koaya  
Christopher Koaya (Name)  
(Chairman, Pres., or Vice-Pres.)

Christopher Koaya  
Christopher Koaya (Name)  
 (Secretary, Asst. Secretary, CFO, or Asst. Treasurer)

Miscellaneous:

For each Contract, the low bid shall be determined as described in the Notice to Bidders.

For each Contract awarded to the undersigned, the undersigned shall, within ten (10) days after mailing, faxing, or delivering of the Notice of Award or prior to the commencement of the Work, whichever is earlier, execute and deliver an agreement in the form of agreement present in these Contract Documents and give Performance and Payment Bonds in accordance with the specifications and bid as accepted.

The undersigned declares that it has read and understands the Contract Documents for each Contract on which it has submitted a bid, including but not limited to the Notice to Bidders, the Instructions to Bidders, the Agreement, the General Conditions, the Drawings, the Specifications, and any Special Conditions.

The undersigned declares that it has read and understands the Contract Documents, including but not limited to the Notice to Bidders, the Instructions to Bidders, the Agreement, the General Conditions, the Drawings, the Specifications, and any Special Conditions.

The undersigned hereby designates as the office to which any Notice of Award of a Contract may be mailed, faxed, or delivered:

668 QUEENSLAND CIR STOCKTON, CA 95206

Our Public Liability and Property Damage Insurance is placed with:

BIBERK

Our Workers' Compensation Insurance is placed with:

Circular letters, bulletins, addenda, etc., bound with the specifications or issued during the time of bidding are included in the undersigned's bid for each Contract, and, in Completing the Contract, they are to become a part thereof.

The receipt of the following addenda to the specifications is acknowledged:

Addendum No. <u>1</u>	Date <u>11/28/2023</u>	Addendum No. _____	Date _____
Addendum No. _____	Date _____	Addendum No. _____	Date _____
Addendum No. _____	Date _____	Addendum No. _____	Date _____

IN WITNESS WHEREOF, the above-bounden parties have executed this instrument under several seals this 28th day of November, 2023, the name and corporate party being hereto affixed and these presents duly signed by its

undersigned representative, pursuant to authority of its governing body. In the presence of:

(Notary Seal)

Data Media Services, Inc.  
(Principal)  
668 Queensland Cir.,  
Stockton, CA 95206  
(Business Address)

WESTERN SURETY COMPANY  
(Corporate Surety)  
151 N. Franklin, 17th Floor  
Chicago, IL 60606  
(Business Address)

By: \_\_\_\_\_

MAURICIO ALEJANDRO GARCIA, ATTORNEY IN FACT

The rate or premium of this bond is N/A per thousand, the total amount of premium charged, \$ 0.00.

(The above must be filled in by Corporate Surety).

1SR7989442

OAKLAND UNIFIED SCHOOL DISTRICT  
VARIOUS SITES  
DOOR ENTRY SYSTEMS GROUP 5 & 6  
PROJECT NO 23126 & 23127

BID BOND  
DOCUMENT 00 40 00





PO Box 5077 Sioux Falls SD 57117-5077

1-800-331-6053  
Fax 1-605-335-0357  
www.cnasurety.com  
uwservices@cnasurety.com

DATE: November 28th, 2023

AGENT CODE: 04 23075

ATTENTION: Anthony

Number of Pages: 5

RE: Bond 72604520 . Data Media Services, Inc.

Various Sites - Door Entry Systems Group 6 Project No 23127  
Specified Penalty

Contract Amount: \$ 119,000.00

Company Code: 0601

Thank you for placing this business with CNA Surety.

Please execute the requested bond(s) by using the documents sent with this fax/email. Sign the bond(s) and attach a gold colored seal from your Western Surety Company kit to each bond issued.

\*\*\*Please advise us of the bid results as soon as they are available. Please complete and fax/email us the following:

Contract Price: \$ \_\_\_\_\_

Contract Date: \_\_\_\_\_

Next two lowest bidders: \$ \_\_\_\_\_  
\$

Was the principal the low bidder?  Yes  No

Do you need approval for the Performance and Payment bond at this time?  Yes  No

Please check your supply of gold seals periodically to ensure you have an adequate amount. To reorder gold seals, simply visit [cnasurety.com](http://cnasurety.com) and click on the "Order Supplies Here" icon under the Broker/Agent Services section.

**\*\*IMPORTANT NOTICE AND REMINDER:** Approval of the requested Bid Bond is NOT an approval of any final or other bonds that may be requested by this principal. Further, the Bid Bond approval is limited to the contract amount approved by the underwriter. If the anticipated bid exceeds this amount, you must contact the underwriter at 800-331-6053 to inquire about specific approval before filing the bid. Failure to receive approval could result in declination of any subsequent performance and payment bond(s) requested. Furthermore, we reserve the right to decline any bond for any reason per the terms of the General Indemnity Agreement, and shall not be liable to the principal or any person or entity for such declination.

Business Services

Acknowledgment of Principal

Acknowledgment of Surety (Attorney-in-Fact)

A notary public or other officer completing this certificate verifies only the identity of the individual who signed the document to which this certificate is attached, and not the truthfulness, accuracy, or validity of that document.

STATE OF CALIFORNIA }  
COUNTY OF ORANGE } ss

On \_\_\_\_\_ before me, \_\_\_\_\_  
date here insert name and title of the officer  
personally appeared MAURICIO ALEJANDRO GARCIA  
name(s) of signer(s)

who proved to me on the basis of satisfactory evidence to be the person(s) whose name(s) is/are subscribed to the within instrument and acknowledged to me that he/she/they executed the same in his/her/their authorized capacity(ies), and that by his/her/their signature(s) on the instrument the person(s), or the entity upon behalf of which the person(s) acted, executed the instrument.

I certify under PENALTY OF PERJURY under the laws of the State of California that the foregoing paragraph is true and correct.

WITNESS my hand and official seal.

Signature \_\_\_\_\_ (Seal)

(The balance of this page is intentionally left blank.)



# Western Surety Company

## POWER OF ATTORNEY - CERTIFIED COPY

Bond No. 72604520

Know All Men By These Presents, that WESTERN SURETY COMPANY, a corporation duly organized and existing under the laws of the State of South Dakota, and having its principal office in Sioux Falls, South Dakota (the "Company"), does by these presents make, constitute and appoint MAURICIO ALEJANDRO GARCIA

its true and lawful attorney(s)-in-fact, with full power and authority hereby conferred, to execute, acknowledge and deliver for and on its behalf as Surety, bonds for:

Principal: Data Media Services, Inc.

Obligee: Oakland Unified School District

Amount: \$1,000,000.00

and to bind the Company thereby as fully and to the same extent as if such bonds were signed by the Vice President, sealed with the corporate seal of the Company and duly attested by its Secretary, hereby ratifying and confirming all that the said attorney(s)-in-fact may do within the above stated limitations. Said appointment is made under and by authority of the following bylaw of Western Surety Company which remains in full force and effect.

"Section 7. All bonds, policies, undertakings, Powers of Attorney or other obligations of the corporation shall be executed in the corporate name of the Company by the President, Secretary, any Assistant Secretary, Treasurer, or any Vice President or by such other officers as the Board of Directors may authorize. The President, any Vice President, Secretary, any Assistant Secretary, or the Treasurer may appoint Attorneys in Fact or agents who shall have authority to issue bonds, policies, or undertakings in the name of the Company. The corporate seal is not necessary for the validity of any bonds, policies, undertakings, Powers of Attorney or other obligations of the corporation. The signature of any such officer and the corporate seal may be printed by facsimile."

This Power of Attorney may be signed by digital signature and sealed by a digital or otherwise electronic-formatted corporate seal under and by the authority of the following Resolution adopted by the Board of Directors of the Company by unanimous written consent dated the 27th day of April, 2022:

"RESOLVED: That it is in the best interest of the Company to periodically ratify and confirm any corporate documents signed by digital signatures and to ratify and confirm the use of a digital or otherwise electronic-formatted corporate seal, each to be considered the act and deed of the Company."

If Bond No. 72604520 is not issued on or before midnight of February 26th, 2024, all authority conferred in this Power of Attorney shall expire and terminate.

In Witness Whereof, Western Surety Company has caused these presents to be signed by its Vice President, Larry Kasten, and its corporate seal to be affixed this 28th day of November, 2023.

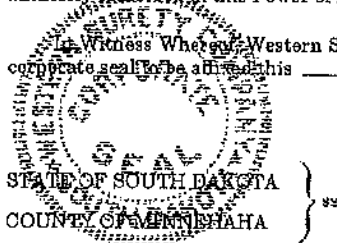

WESTERN SURETY COMPANY

Larry Kasten  
Larry Kasten, Vice President

On this 28th day of November, in the year 2023, before me, a notary public, personally appeared Larry Kasten, who being to me duly sworn, acknowledged that he signed the above Power of Attorney as the aforesaid officer of WESTERN SURETY COMPANY and acknowledged said instrument to be the voluntary act and deed of said corporation.

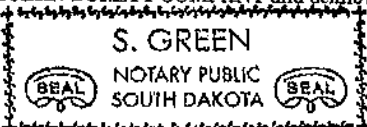

My Commission Expires February 12, 2027

S. Green  
Notary Public - South Dakota

I the undersigned officer of Western Surety Company, a stock corporation of the State of South Dakota, do hereby certify that the attached Power of Attorney is in full force and effect and is irrevocable, and furthermore, that Section 7 of the bylaws of the Company as set forth in the Power of Attorney is now in force.

In testimony whereof, I have hereunto set my hand and seal of Western Surety Company this 28th day of November, 2023.

WESTERN SURETY COMPANY

Larry Kasten  
Larry Kasten, Vice President

DESIGNATION OF SUBCONTRACTORS  
DOCUMENT 00 40 01

PROJECT: VARIOUS SITES - DOOR ENTRY SYSTEM  
(Project Name)  
PROJECT NO: 23127 BIDDER'S NAME DATA MEDIA SERVICES INC  
DIR 10 Digit Registration No: 1000591508

Each bidder shall set forth below the name and the location of the place of business of each subcontractor, and the California contractor license number and (for all projects over Twenty-Five Thousand Dollars (\$25,000)) public works contractor registration number of each subcontractor who will perform work or labor or render service to the Contractor in or about the construction of the Work or improvement, or to a subcontractor licensed by the State of California who, under subcontract to the Contractor, specially fabricates and installs a portion of the Work or improvement according to detailed drawings contained in the plans and specifications, in an amount in excess of one-half of 1 percent (0.5%) of the bidder's total bid, and the portion of the Work which will be done by each subcontractor. An inadvertent error in listing a California contractor's license number shall not be grounds for filing a bid protest or for considering the bid nonresponsive if the bidder submits the corrected contractor's license number to the Owner within 24 hours after the bid opening, or any continuation thereof, so long as the corrected contractor's license number corresponds to the submitted name and location for that subcontractor.

If the Contractor fails to specify a subcontractor for any portion of the Work to be performed under the Contract in excess of one-half of 1 percent (0.5%) of the Contractor's total bid, the Contractor shall be deemed to have agreed to perform such portion itself, and shall not be permitted to subcontract that portion of the Work except under the conditions hereinafter set forth.

Subletting or subcontracting of any portion of the Work as to which no subcontractor was designated in the original bid shall only be permitted in cases of public emergency or necessity, and then only after a finding reduced to writing as a public record of the legislative body of the Owner.

For all projects over Twenty-Five Thousand Dollars (\$25,000): For any bid proposal submitted, and for any contract for public work entered into, an inadvertent error in listing a subcontractor who is not registered under Labor Code section 1725.5 shall not be grounds for filing a bid protest or grounds for considering the bid nonresponsive, provided that either: the subcontractor is registered prior to the bid opening; or the subcontractor is registered and has paid the penalty registration fee specified in Labor Code section 1725.5(a)(2)(E), if applicable, within 24 hours after the bid opening; or the subcontractor is replaced by another registered subcontractor under Public

Contract Code section 4107. Failure of a listed subcontractor to be registered under Public Contract Code section 4107 for the Contractor, with the Owner's consent, to substitute a registered subcontractor for the unregistered subcontractor.

Failure to provide this information in a legible manner may result in the rejection of an otherwise acceptable bid.

**NOTE:** Reproduce page two of this section for additional listings needed beyond the length of this form.

Portion of Work (description)	Portion of Work (dollar amount)	Name of Subcontractor & Phone No.	Location of Subcontractor	California Contractor License Number	Public Works Contractor Registration Number
		SELF			

SERK F PERFORM

I am the authorized representative of the Bidder submitting this Designation of Subcontractors and I declare that each subcontractor listed holds a valid and current contractor license in good standing in California to perform the portion of work for which the subcontractor is listed.

I declare under penalty of perjury under the laws of the State of California that the foregoing is true and correct and that this declaration is executed on 11-28, 2021, at Starkville [city], CA [state].

Signature:   
 Print Name: Christopher Koenig  
 Title: Owner

**SITE VISIT CERTIFICATION**  
**DOCUMENT 00 40 02**

TO BE EXECUTED BY BIDDER AND SUBMITTED WITH BID  
IF SITE VISIT WAS MANDATORY

PROJECT: **Various Sites Door Entry Systems Group 5 & 6**

Check option that applies:

I certify that I visited the Site of the proposed Work and became fully acquainted with the conditions relating to construction and labor. I fully understand the facilities, difficulties, and restrictions attending the execution of the Work under contract.

I certify that Calvin Anderson (Bidder's representative) visited the Site of the proposed Work and became fully acquainted with the conditions relating to construction and labor. The Bidder's representative fully understood the facilities, difficulties, and restrictions attending the execution of the Work under contract.

Bidder fully indemnifies the Oakland Unified School District, its Architect, its Engineer, its Construction Manager, and all of their respective officers, agents, employees, and consultants from any damage, or omissions, related to conditions that could have been identified during my visit and/or the Bidder's representative's visit to the Site.

I certify under penalty of perjury under the laws of the State of California that the foregoing is true and correct.

Date:

11/28/2023

Proper Name of Bidder:

DATA MEDIA SERVICES RIC

Signature:

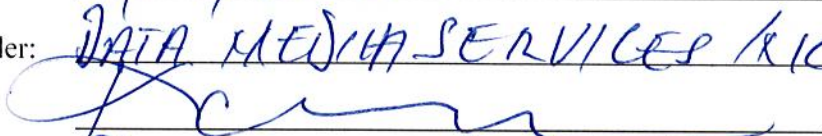

Print Name:

CHRISTOPHER KOZMEN

Title:

OWNER

END OF DOCUMENT

**NONCOLLUSION DECLARATION**  
**DOCUMENT 00 40 03**

Owner: Oakland Unified School District  
Contract: Various Sites Door Entry Systems Group 5 & 6

The undersigned declares:

I am the OWNER of DATA MEDIA SERVICE the party making the foregoing bid or proposal ("Bid").

The Bid is not made in the interest of, or on behalf of, any undisclosed person, partnership, company, association, organization, or corporation. The Bid is genuine and not collusive or sham. The bidder or proposer ("Bidder") has not directly or indirectly induced or solicited any other Bidder to put in a false or sham bid. The Bidder has not directly or indirectly colluded, conspired, connived, or agreed with any Bidder or anyone else to put in a sham Bid, or to refrain from bidding or proposing ("Bidding"). The Bidder has not in any manner, directly or indirectly, sought by agreement, communication, or conference with anyone to fix the Bid price of the Bidder or any other Bidder, or to fix any overhead, profit, or cost element of the Bid price, or of that of any other Bidder. All statements contained in the Bid are true. The Bidder has not, directly or indirectly, submitted his or her Bid price or any breakdown thereof, or the contents thereof, or divulged information or data relative thereto, to any corporation, partnership, company, association, organization, Bid depository, or to any member or agent thereof to effectuate a collusive or sham Bid, and has not paid, and will not pay, any person or entity for such purpose.

Any person executing this declaration on behalf of a Bidder that is a corporation, partnership, joint venture, limited liability company, limited liability partnership, or any other entity, hereby represents that he or she has full power to execute, and does execute, this declaration on behalf of the Bidder.

I declare under penalty of perjury under the laws of the State of California that the foregoing is true and correct and that this declaration is executed on 11/28, 2008 at STOUGHTON [city], CA [state].

  
Signature

Christopher Koayen  
Print Name

OAKLAND UNIFIED SCHOOL DISTRICT  
VARIOUS SITES  
DOOR ENTRY SYSTEMS GROUP 5 & 6  
PROJECT NO 23126 & 23127

NON-COLLUSION  
DOCUMENT 00 40 03



**WORKERS' COMPENSATION CERTIFICATE**  
**DOCUMENT 00 40 05**

Labor Code Section 3700, in relevant part, provides:

"Every employer except the state shall secure the payment of compensation in one or more of the following ways:

(a) By being insured against liability to pay compensation in one or more insurers duly authorized to write compensation insurance in this state.

(b) By securing from the Director of Industrial Relations a certificate of consent to self-insure either as an individual employer or as one employer in a group of employers. Said certificate may be given upon furnishing proof satisfactory to the Director of Industrial Relations of ability to self-insure and to pay any compensation that may become due to his or her employees, ... "

I am aware of the provisions of the Labor Code Section 3700 which require every employer to be insured against liability for workers' compensation or to undertake self-insurance in accordance with the provisions of that code, and I will comply with such provisions before commencing the performance of the work of this contract. I shall supply the Owner with certificates of insurance evidencing that Workers' Compensation Insurance is in effect and providing that the Owner will receive thirty (30) days' notice of cancellation.

DATA MEDIA SERVICES INC.

Name of Contractor

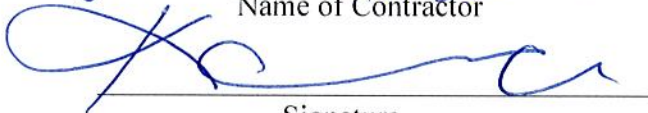

Signature

Christopher Koayer (1/28/2022)

Print Name

Date

(In accordance with Article 5 (commencing at Section 1860), Chapter 1, Part 7, Division 2 of the Labor Code, the above certificate must be signed and filed with the awarding body prior to performing any work under the contract.)

**PREVAILING WAGE AND  
RELATED LABOR REQUIREMENTS CERTIFICATION  
DOCUMENT 00 40 06**

PROJECT/CONTRACT NO. 23126 & 23127 between Oakland Unified School District ("District") and DATA MEDIA SERVICES INC. ("Contractor" or "Bidder") ("Contract" or "Project").

I hereby certify that I will conform to the State of California public works contract requirements regarding prevailing wages, benefits, on-site audits with 48-hours' notice, payroll records, and apprentice and trainee employment requirements, for all Work on the above Project including, without limitation, labor compliance monitoring and enforcement by the Department of Industrial Relations.

I hereby certify that I will also conform to the Federal Labor Standards Provisions regarding minimum wages, withholding, payrolls and basic records, apprentice and trainee employment requirements, equal employment opportunity requirements, Copeland Act requirements, Davis-Bacon and Related Act requirements, Contract Work Hours and Safety Standards Act requirements, and any and all other applicable requirements for federal funding for all Work on the above Project.

Date: 11/28/2023  
Proper Name of Contractor: DATA MEDIA SERVICES INC  
Signature: [Signature]  
Print Name: CHRISTOPHER KOAYEYU  
Title: Project Director

END OF DOCUMENT

**PRIME BIDDER CERTIFICATION OF DISABLED VETERAN  
BUSINESS ENTERPRISE PARTICIPATION**

**DOCUMENT 00 41 00**

To be completed by the Prime Bidder

PAGE 1 OF 2

PART I – IDENTIFICATION INFORMATION		
BIDDER'S NAME <i>DATA MEDIA SERVICES</i>	BUSINESS ADDRESS <i>517 17th St. OAKLAND, CA 94612</i>	TELEPHONE NUMBER <i>209 688-1385</i>
SCHOOL DISTRICT <i>USD</i>	COUNTY <i>ALAMEDA</i>	APPLICATION NO.

**PART II – METHOD OF COMPLIANCE WITH DVBE PARTICIPATION GOALS** – Include this form and any other applicable documents listed in this table with your bid/proposal. Read the three columns in the table below as sentences from left to right. Check the appropriate box to indicate your method of committing the contract dollar amount.

**NOTE:** Architectural, engineering, environmental, land surveying or construction management firms must indicate their method of compliance by marking the appropriate box A, B, C, or D after selection by the District and before the contract is signed.

YOUR BUSINESS ENTERPRISE	AND YOU	AND YOU
A. <input type="checkbox"/> is Disabled Veteran owned and your forces, will perform at least 3 percent of this contract	will include a copy of your DVBE letter from the Office of Small Business and Disabled Veteran Business Enterprise Services (OSDS).	
B. <input type="checkbox"/> is Disabled Veteran owned but is unable to perform the 3 percent of this contract with your forces	will use DVBE subcontractors/ suppliers to bring the contract participation to at least 3 percent	will include a copy of each DVBE's letter from OSDS (including yours, if applicable).
C. <input checked="" type="checkbox"/> is not Disabled Veteran owned	will use DVBE subcontractors/ suppliers for at least 3 percent of this contract	<i>I am a small BUSINESS OWNER</i>
D. <input type="checkbox"/> is unable to meet the required participation goals	will complete a Good Faith Effort to obtain DVBE participation	will include the Prime Bidder's Good Faith Effort Worksheet.

**Note:** An Office of Small Business and Disabled Veteran Business Enterprise Services (OSDS) letter must be attached for each DVBE participating in the contract. The DVBE letter is obtained by application through the OSDS and must be provided at the time of bid opening. If the letter is not provided, the bid may be deemed nonresponsive and may be ineligible for award of the contract.

Continued on reverse side

**PART III – DVBE DOLLAR PARTICIPATION OF BID/PROPOSAL** – Architectural, engineering, environmental, land surveying or construction management firms complete this part *after* selection by the district and before the contract is signed.

Show deductive alternate(s) in parenthesis. For more alternates/base bids, use a separate page to show items.

- A. If your business enterprise is a DVBE, list in the appropriate column the total dollar amount of your bid to be performed by your own participation.
- B. List all your DVBE subcontractors/suppliers. Enter in the appropriate column the dollar amount for each of your subcontractors/suppliers.
- C. Enter the total of Lines A and B for each column.
- D. Enter the dollar amount of the bid/proposal to be performed by non-DVBE firms. Note: This line is the sum of the prime and subcontractor(s) non-DVBE dollar participation.
- E. Enter the sum of the column totals from Line C and Line D. Note: Please be aware that the final determination of DVBE compliance is made based on the contract amount resulting from the district's acceptance or rejection of alternates.

	BASE BID/PROPOSAL	ALTERNATE #1	ALTERNATE #2	ALTERNATE #3 OR BASE BID B	ALTERNATE #4 OR BASE BID C	ALTERNATE #5 (Modernization or Reconstruction Only)
A. Prime Bidder, if DVBE (own participation)	\$	\$	\$	\$	\$	\$
B. DVBE Subcontractor or Supplier						
1.						
2.						
3.						
4.						
C. Subtotal (A & B)						
D. Non-DVBE						
E. Total Bid						

OAKLAND UNIFIED SCHOOL DISTRICT  
 VARIOUS SITES  
 DOOR ENTRY SYSTEMS GROUP 5 & 6  
 PROJECT NO. 23126 & 23127  
 {SR798826}

DVBE PARTICIPATION CERTIFICATE  
 DOCUMENT 00 41 00

OAKLAND UNIFIED SCHOOL DISTRICT  
VARIOUS SITES  
DOOR ENTRY SYSTEMS GROUP 5 & 6  
PROJECT NO. 23126 & 23127  
!SR798826!

DVBE PARTICIPATION CERTIFICATE  
DOCUMENT 00 41 00

BIDDER'S NAME <b>DATA MEDIA SERVICES</b>	BUSINESS ADDRESS <b>567 14th St OAKLAND, CA</b>	CONTACT PERSON <b>DATA MEDIA SERVICES</b>
TELEPHONE NUMBER <b>209-688-1385</b>	OWNER <b>Christopher KOAYEN</b>	COUNTY <b>ALAMEDA</b>

**GENERAL INSTRUCTIONS:**

This worksheet is to be used to assist you in meeting the 3 percent DVBE participation goal. If specific information is not provided for Parts I through III, you do not meet the test of the "Good Faith Effort" and cannot so certify. If you are qualifying based on a "Good Faith Effort" you must include this form with your bid/proposal to the Owner.

**PART I – CONTACTS**

To identify DVBE subcontractors/suppliers for participation in your bid/proposal, contact must be made with each of the following categories. It is recommended that you contact several DVBE organizations.

CATEGORY	TELEPHONE NUMBER	DATE CONTACTED	PERSON CONTACTED
1. Owner			
2. Office of Small Business and Disabled Veteran Business Enterprise Services (OSDS). OSDS provides assistance locating DVBE's at <a href="https://caleprocure.ca.gov/pages/PublicSearch/suppliersearch.aspx">https://caleprocure.ca.gov/pages/PublicSearch/suppliersearch.aspx</a>	(916) 375-4940		
3. DVBE Organizations (List):			
4. Write "recorded message" in this column, if applicable.			

*Y/A*

**PART II – ADVERTISEMENTS** You must make at least two (2) advertisements, one (1) in a paper that focuses on DVBE and one (1) in a trade paper. Advertisements should be published at least 14 days prior to bid/proposal opening; if you cannot advertise 14 days prior, advertise as soon as possible and provide an explanation. (Advertisements must be published in time to allow for a reasonable response). Advertisements must include that your firm is seeking DVBE participation, the project name and location, your firm’s name, your firm’s contact person, and phone number.

*Attach copies of advertisements to this form.*

FOCUS/TRADE PAPER NAME	CHECK ONE		DATE OF ADVERTISEMENT
	TRADE	FOCUS	

**PART III – DVBE SOLICITATIONS** List DVBE subcontractors/suppliers that were invited to bid. Use the following instructions to complete the remainder of this section (read the three columns as a sentence from left to right). If you need additional space to list DVBE solicitations, please use a separate page and attach to this form.

IF THE DVBE.....	THEN.....	AND.....
Was selected to participate	Check "yes" in the "SELECTED" column, include the applicable dollar amount in Part III of the Prime Bidder Certification	Include a copy of their DVBE letter from OSDs.
Was not selected to participate	Check "no" in the "SELECTED" column	State why in the "REASON NOT SELECTED" column.
Did not respond to your solicitation	Check the "NO RESPONSE" column	

DISABLED VETERANS BUSINESS ENTERPRISES CONTACTED	SELECTED		REASON NOT SELECTED <i>This section must be completed</i>	NO RESPONSE
	YES	NO		

**IMPORTANT NOTE:**

Please be aware that certification of the "Good Faith Effort" may only be made if you fully complete Parts I, II, and III on both sides of this form. A copy of this form must be retained by you and may be subject to a future audit.

I, Christopher KAYEEL **CERTIFICATION** certify that I am the bidder's Chief Executive Officer and that I have made a diligent effort to ascertain the facts with regard to the representations made herein. In making this certification, I am aware of Section 12650 et seq. of the Government Code providing for the imposition of treble damages for making false claims.

SIGNATURE OF CHIEF EXECUTIVE OFFICER 	DATE 11/28/2023
---	--------------------

**DRUG-FREE WORKPLACE CERTIFICATION**  
**DOCUMENT 00 42 00**

The Drug-Free Workplace Act of 1990 (Government Code sections 8350 *et seq.*) requires that every person or organization awarded a contract or grant for the procurement of any property or services from any State agency must certify that it will provide a drug-free workplace by doing certain specified acts. In addition, the Act provides that each contract awarded by a State agency may be subject to suspension of payments or termination of the contract, or both, and the contractor may be subject to debarment from future contracting if the state agency determines that specified acts have occurred.

Pursuant to Government Code Section 8355, every person or organization awarded a contract or grant from a State agency shall certify that it will provide a drug-free workplace by doing all of the following:

- (a) Publishing a statement notifying employees that the unlawful manufacture, distribution, dispensation, possession or use of a controlled substance is prohibited in the person's or organization's workplace and specifying actions which will be taken against employees for violations of the prohibition;
- (b) Establishing a drug-free awareness program to inform employees about all of the following:
  - (1) The dangers of drug abuse in the workplace;
  - (2) The person's or organization's policy of maintaining a drug-free workplace;
  - (3) The availability of drug counseling, rehabilitation and employee-assistance programs;
  - (4) The penalties that may be imposed upon employees for drug abuse Violations;
- (c) Requiring that each employee engaged in the performance of the contract or grant be given a copy of the statement required by subdivision (a) and that, as a condition of employment on the contract or grant, the employee agrees to abide by the terms of the statement.

I, the undersigned, agree to fulfill the terms and requirements of Government Code Section 8355 listed above and will publish a statement notifying employees concerning (a) the prohibition of controlled substance at the workplace, (b) establishing a drug-free awareness program, and (c) requiring that each employee engaged in the performance of the contract or grant be given a copy of the statement required by Section 8355(a) and requiring that the employee agree to abide by the terms of that statement.

I also understand that if the Owner determines that I have either (a) made a false certification herein, or (b) violated this certification by failing to carry out the requirements of Section 8355, that the contract or grant awarded herein is subject to suspension of payments, termination, or both. I further understand that should I violate the terms of the Drug-Free Workplace Act of 1990, I may be subject to debarment in accordance with the requirements of Section 8350 *et seq.*

I acknowledge that I am aware of the provisions of Government Code Section 8350 *et seq.* and hereby certify that I will adhere to the requirements of the Drug-Free Workplace Act of 1990.

DATA MEDIA SERVICES  
 Name of Contractor

[Signature]  
 Signature

Christopher Koyka 11/28/2023  
 Print Name Date



**TOBACCO-FREE ENVIRONMENT CERTIFICATION**  
**DOCUMENT 00 42 01**

PROJECT NO <sup>23127</sup> 23126 ("Project") between Oakland Unified School District (the "District" or the "Owner") and DATA MEDIA SERVICES (the "Contractor" or the "Bidder").

This Tobacco-Free Environment Certification form is required from the successful Bidder.

Pursuant to, without limitation, 20 U.S.C. section 6083, Labor Code sections 6400 et seq., Health & Safety Code sections 104350 et seq., and District Board Policies, all District sites, including the Project site, are tobacco-free environments. Smoking and the use of tobacco products by all persons is prohibited on or in District property. District property includes school buildings, school grounds, school owned vehicles and vehicles owned by others while on District property.

I acknowledge that I am aware of the District's policy regarding tobacco-free environments at District sites, including the Project site, and I hereby certify that I will adhere to the requirements of that policy and not permit any of my firm's employees, agents, subcontractors, or my firm's subcontractors' employees or agents to use tobacco and/or smoke on the Project site.

Date:

11/28/2023

Proper Name of Contractor:

DATA MEDIA SERVICES INC

Signature:

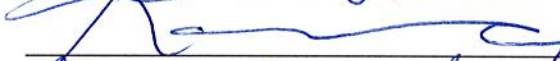

Print Name:

Christopher Kaayon

Title:

OWNER

**FINGERPRINTING NOTICE AND ACKNOWLEDGMENT  
FOR CONSTRUCTION CONTRACTS**  
(Education Code Section 45125.2)  
**DOCUMENT 00 43 00**

Business entities entering into contracts with the Owner for the construction, reconstruction, rehabilitation or repair of a facility may comply with Education Code section 45125.2, in which case it would not have to comply with Section 45125.1. If such an entity is not compliant with Section 45125.2, then it must comply with Section 45125.1. Such entities are responsible for ensuring full compliance with the law and should therefore review all applicable statutes and regulations. Therefore, the following information is provided simply to assist you with compliance with the law:

1. The Owner has determined that your employee(s), or you as a sole proprietor, will have more than limited contact with students, therefore the law requires that you must use one or more of the following methods to ensure the safety of pupils (Education Code §45125.2(a)):
  - a. Install a physical barrier at the worksite to limit contact with pupils.
  - b. If you are not a sole proprietorship, have one of your employees, whom the Department of Justice has ascertained has not been convicted of a violent or serious felony (see *Attachment A* to this Notice and Acknowledgement), continually monitor and supervise all of your employees. For the Department of Justice to so ascertain, your employee may submit fingerprints to the Department of Justice pursuant to Education Code section 45125.1(a).
  - c. Arrange, with Owner's approval, for surveillance of your employees by Owner's personnel.

Prior to commencing the Work, you shall submit the Independent Contractor Student Contact Form (see *Attachment B* to this Notice and Acknowledgement) to the Owner, which will indicate which of the above methods you will use.

2. If you are providing services in an emergency or exceptional situation, you are not required to comply with Education Code section 45125.2, above. An "emergency or exceptional" situation is one in which pupil health or safety is endangered or when repairs are needed to make a facility safe and habitable. Owner shall determine whether an emergency or exceptional situation exists. (Education Code §45125.2(d).)

3. If you use one or more of the three methods in Section 1 (above), you are not required to comply with Education Code section 45125.1. (Education Code §45125.2(b).)

I have read the foregoing and agree to comply with the requirements of this notice and Education Code sections 45125.1 and 45125.2 as applicable.

Dated: 11/28/2022 Signature   
Name: Christopher Koyen Title: OWNER

## ATTACHMENT A

### Violent and Serious Felonies

Under Education Code section 45125.2, no employee of a contractor or subcontractor who has been convicted of or has criminal proceedings pending for a violent or serious felony may come into contact with any student. A violent felony is any felony listed in subdivision (c) of Section 667.5 of the Penal Code. Those felonies are presently defined as:

- (1) Murder or voluntary manslaughter.
- (2) Mayhem.
- (3) Rape as defined in paragraph (2) or (6) of subdivision (a) of Section 261 or paragraph (1) or (4) of subdivision (a) of Section 262.
- (4) Sodomy as defined in subdivision (c) or (d) of Section 286.
- (5) Oral copulation as defined in subdivision (c) or (d) of Section 288a.
- (6) Lewd or lascivious act as defined in subdivision (a) or (b) of Section 288.
- (7) Any felony punishable by death or imprisonment in the state prison for life.
- (8) Any felony in which the defendant inflicts great bodily injury on any person other than an accomplice which has been charged and proved as provided for in Section 12022.7, 12022.8, or 12022.9 on or after July 1, 1977, or as specified prior to July 1, 1977, in Sections 213, 264, and 461, or any felony in which the defendant uses a firearm which use has been charged and proved as provided in subdivision (a) of Section 12022.3, or Section 12022.5 or 12022.55.
- (9) Any robbery.
- (10) Arson, in violation of subdivision (a) or (b) of Section 451.
- (11) Sexual penetration as defined in subdivision (a) or (j) of Section 289.
- (12) Attempted murder.
- (13) A violation of Section 18745, 18750, or 18755.
- (14) Kidnapping.

{SR798850}3

- (15) Assault with the intent to commit a specified felony, in violation of Section 220.
- (16) Continuous sexual abuse of a child, in violation of Section 288.5.
- (17) Carjacking, as defined in subdivision (a) of Section 215.
- (18) Rape, spousal rape, or sexual penetration, in concert, in violation of Section 264.1.
- (19) Extortion, as defined in Section 518, which would constitute a felony violation of Section 186.22 of the Penal Code.
- (20) Threats to victims or witnesses, as defined in Section 136.1, which would constitute a felony violation of Section 186.22 of the Penal Code.
- (21) Any burglary of the first degree, as defined in subdivision (a) of Section 460, wherein it is charged and proved that another person, other than an accomplice, was present in the residence during the commission of the burglary.
- (22) Any violation of Section 12022.53.
- (23) A violation of subdivision (b) or (c) of Section 11418.

A serious felony is any felony listed in subdivision (c) Section 1192.7 of the Penal Code. Those felonies are presently defined as:

- (1) Murder or voluntary manslaughter; (2) Mayhem; (3) Rape; (4) Sodomy by force, violence, duress, menace, threat of great bodily injury, or fear of immediate and unlawful bodily injury on the victim or another person; (5) Oral copulation by force, violence, duress, menace, threat of great bodily injury, or fear of immediate and unlawful bodily injury on the victim or another person; (6) Lewd or lascivious act on a child under the age of 14 years; (7) Any felony punishable by death or imprisonment in the state prison for life; (8) Any felony in which the defendant personally inflicts great bodily injury on any person, other than an accomplice, or any felony in which the defendant personally uses a firearm; (9) Attempted murder; (10) Assault with intent to commit rape, or robbery; (11) Assault with a deadly weapon or instrument on a peace officer; (12) Assault by a life prisoner on a non-inmate; (13) Assault with a deadly weapon by an inmate; (14) Arson; (15) Exploding a destructive device or any explosive with intent to injure; (16) Exploding a destructive device or any explosive causing bodily injury, great bodily injury, or mayhem; (17) Exploding a destructive device or any explosive with intent to murder; (18) Any burglary of the first degree; (19)

{SR798850}4

Robbery or bank robbery; (20) Kidnapping; (21) Holding of a hostage by a person confined in a state prison; (22) Attempt to commit a felony punishable by death or imprisonment in the state prison for life; (23) Any felony in which the defendant personally used a dangerous or deadly weapon; (24) Selling, furnishing, administering, giving, or offering to sell, furnish, administer, or give to a minor any heroin, cocaine, phencyclidine (PCP), or any methamphetamine-related drug, as described in paragraph (2) of subdivision (d) of Section 11055 of the Health and Safety Code, or any of the precursors of methamphetamines, as described in subparagraph (A) of paragraph (1) of subdivision (f) of Section 11055 or subdivision (a) of Section 11100 of the Health and Safety Code; (25) Any violation of subdivision (a) of Section 289 where the act is accomplished against the victim's will by force, violence, duress, menace, or fear of immediate and unlawful bodily injury on the victim or another person; (26) Grand theft involving a firearm; (27) carjacking; (28) any felony offense, which would also constitute a felony violation of Section 186.22; (29) assault with the intent to commit mayhem, rape, sodomy, or oral copulation, in violation of Section 220; (30) throwing acid or flammable substances, in violation of Section 244; (31) assault with a deadly weapon, firearm, machine gun, assault weapon, or semiautomatic firearm or assault on a peace officer or firefighter, in violation of Section 245; (32) assault with a deadly weapon against a public transit employee, custodial officer, or school employee, in violation of Sections 245.2, 245.3, or 245.5; (33) discharge of a firearm at an inhabited dwelling, vehicle, or aircraft, in violation of Section 246; (34) commission of rape or sexual penetration in concert with another person, in violation of Section 264.1; (35) continuous sexual abuse of a child, in violation of Section 288.5; (36) shooting from a vehicle, in violation of subdivision (c) or (d) of Section 26100; (37) intimidation of victims or witnesses, in violation of Section 136.1; (38) criminal threats, in violation of Section 422; (39) any attempt to commit a crime listed in this subdivision other than an assault; (40) any violation of Section 12022.53; (41) a violation of subdivision (b) or (c) of Section 11418; and (42) any conspiracy to commit an offense described in this subdivision.

{SR798850} 5

ATTACHMENT B

INDEPENDENT CONTRACTOR STUDENT CONTACT FORM  
FOR CONSTRUCTION CONTRACTS

*Note: This form must be submitted by Contractor before it may commence any work.*

Contractor Firm Name: \_\_\_\_\_  
Supervisor/Foreman Name: \_\_\_\_\_  
Start Date: \_\_\_\_\_  
Completion Date: \_\_\_\_\_  
Location of Work: \_\_\_\_\_  
Hours of Work: \_\_\_\_\_  
Length of Time on Grounds: \_\_\_\_\_  
Number of Employees on the Job: \_\_\_\_\_

*N/A*

I am an owner or officer of Contractor authorized to sign this document on behalf of Contractor. Contractor acknowledges that the Owner has determined that Contractor's employees, or that Contractor as a sole proprietor, will have more than limited contact with students. Therefore, in order to comply with Education Code section 45125.2, Contractor will use the following methods to ensure student safety (check at least one):

- A physical barrier will be installed at the worksite to limit contact with pupils.
- Contractor is not a sole proprietorship, and its employees will be continually monitored and supervised by one of its employees who has not been convicted of a violent or serious felony.

Name of Supervising Employee: \_\_\_\_\_  
*N/A*

Date of Department of Justice verification that supervising employee has not been convicted of a violent or serious felony:  
\_\_\_\_\_

Name of employee who is the custodian of the Department of Justice verification information: \_\_\_\_\_  
*N/A*

{SR798850}6

[4] The Owner has agreed that Contractor's employees, or Contractor as sole proprietor, will be surveilled by Owner's personnel.

If Contractor does not comply with the requirements of Education Code section 45125.2, then Contractor will comply with the requirements of Education Code section 45125.1.

I declare under penalty of perjury that the foregoing is true and correct to the best of my knowledge.

Dated: 11/28/2020

Signature:   
Typed Name: CHRISTOPHER KOAYEN  
Title: OWNER  
Contractor: DATA MEDIA SERVICE



**SCHEDULE Z**  
**DOCUMENT 00 52 00**

**CERTIFICATION REGARDING DEBARMENT, SUSPENSION, INELIGIBILITY  
AND VOLUNTARY EXCLUSION – LOWER TIER COVERED TRANSACTION**

Under the requirements of OMB Circular A-133 Supplement, part 3, Section 1, the District is required to obtain certifications that contractors and sub-grantees receiving awards exceeding \$25,000 have not been suspended or debarred from participating in federally funded procurement activities.

The undersigned company certifies to the best of its knowledge and belief that neither it nor its principals is presently debarred, suspended, proposed for debarment, declared ineligible or voluntarily excluded from participation in this transaction by any Federal department or agency; and that none of its subcontractors are presently debarred, suspended, proposed for debarment, declared ineligible or voluntarily excluded from participation in this transaction by any Federal department or agency.

If the undersigned company is unable to certify to the above statement, it shall attach an explanation to this proposal.

By signing and submitting this form the company's authorized representative hereby certifies as to the above stated conditions.

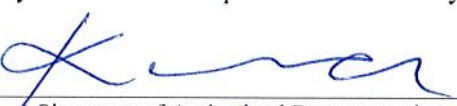
<u>DATA MEDIA SERVICES</u>	
Company Name	Signature of Authorized Representative
<u>562 14<sup>th</sup> St. OAKLAND CA. 94612</u>	<u>Christopher Kouylen</u>
Address	Type or Print Name
<u>94612</u>	<u>209-688385 11/28/23</u>
Area Code	Phone
	Date
	<u>Christopher Kouylen</u>
	Type or Print Name

**END OF DOCUMENT**

Oakland Unified School District  
Division of Facilities Planning and Management  
955 High Street  
Oakland, CA 94601

# PROJECT SPECIFICATIONS

## Various Sites Door Entry System Group 5 Project

**No 23126-** Oakland Tech Upper Campus, Montera Middle School, Jefferson CDC, Hillcrest Elementary School & Bella Vista CDC.

## Various Sites Door Entry System Group 6 Project

**No 23127-** Thornhill Elementary School, Oakland Academy of Knowledge, Lockwood Steam Academy, Lockwood CDC, & Kaiser Early Childhood Center.



**OAKLAND UNIFIED SCHOOL DISTRICT**  
Various Sites  
Door Entry Systems Group 5 & 6  
PROJECT NO: 23126 & 23127  
November 9, 2023

**Cover Title Page**  
**Document 00 01 01**

**TABLE OF CONTENTS**  
**DOCUMENT 00 01 07**

<b><u>Number</u></b>	<b><u>Document Name</u></b>
	DIVISION 00 - BIDDING REQUIREMENTS, CONTRACT FORMS, & CONDITIONS OF THE CONTRACT
00 01 01	Cover / Title Page
00 01 02	Signature Page
00 01 07	Table of Contents
00 01 08	List of Drawings
00 01 09	List of Schedules
00 11 11	Notice to Bidders
00 11 12	Instructions to Bidders
00 11 13	Sufficient Funds Declaration
00 21 00	Questionnaire Regarding Qualifications
00 21 01	Existing Conditions
00 21 02	Geotechnical Data
00 31 00	Bid Cover Sheet
00 31 01	Bid Form and Proposal
00 40 00	Bid Bond (Security)
00 40 01	Designated Subcontractors List
00 40 02	Site-Visit Certification
00 40 03	Non-collusion Affidavit
00 40 04	Iran Contracting Act Certification
00 40 05	Worker's Compensation Certification
00 40 06	Prevailing Wage and Related Labor Requirements Certification
00 41 00	Disabled Veteran's Business Enterprise Participation Certification
00 41 01	Disabled Veteran's Business Enterprise Good Faith Effort Worksheet
<del>00 41 02</del>	<del>Local Business Enterprise Policy</del>
<del>00 41 03</del>	<del>Local Business Enterprise Program</del>
<del>00 41 04</del>	<del>Local Business Participation Form</del>
00 41 05	Supplemental Questionnaire for Certification
00 42 00	Drug-Free Workplace Certification
00 42 01	Tobacco-Free Environment Certification
00 42 02	Asbestos & Other Hazardous Materials Certification
00 42 03	Lead-Based Materials Certification
00 42 04	Imported Materials Certification
00 43 00	Fingerprinting Notice & Acknowledging Certification
<del>00 43 01</del>	<del>Buy American Certification</del>
00 43 02	Roofing Project Certification
00 43 03	Change Order Form

**TABLE OF CONTENTS  
DOCUMENT 00 01 07**

<b><u>Number</u></b>	<b><u>Document Name</u></b>
00 50 00	Notice of Award
00 51 00	Guarantee Form
00 51 01	Notice to Proceed
00 52 00	Schedule Z Debarment Suspension
00 52 13	Agreement
00 53 00	Escrow of Bid Documentation
00 53 01	Escrow Agreement in Lieu of Retention
00 61 00	Performance Bond
00 61 01	Payment Bond
00 62 00	General Conditions
00 62 01	Special Conditions
00 63 00	Hazardous Materials Certification
00 63 01	Working Under the Project Labor Agreement
<del>00 63 02</del>	<del>Project Labor Agreement</del>

DIVISION 01 - GENERAL REQUIREMENTS

DIVISION 01 - GENERAL REQUIREMENTS

01 11 00 – 01 79 00 Sections

Diagrams Group 5 & 6

END OF DOCUMENT

**DOCUMENT 00 01 08**

**LIST OF DRAWINGS**

**SHEET NO.**            **DESCRIPTION**

Diagrams are listed in the back of specs for both projects.

End of Document

**LIST OF SCHEDULES**  
**DOCUMENT 00 01 09**

WORK SCHEDULE:

The following is the anticipated schedule for this project:

Bid Award: January 10, 2024

Notice To Proceed: January 11, 2024

Project Completion: TBD

Total Duration: 90 Calendar Days

END OF DOCUMENT

**NOTICE TO BIDDERS**  
**DOCUMENT 00 11 11**

Notice is hereby given that the Oakland Unified School District (hereinafter referred to as "Owner") will receive sealed bids prior to the date and time stated for the bid opening for the award of contracts to construct the following:

**Various Sites – Door Entry Systems Group 5 Project No 23126 – location is listed below (Contract”),**

The Scope of work to include Installation of AIPhone door entry intercom systems at various sites. Sites: Oakland Tech Upper Campus, Montera Middle School, Jefferson CDC, Hillcrest Elementary School, & Bella Vista CDC.

**Engineer’s Estimate for each project is: \$150,000.00**  
**Please submit separately for each bid.**

**Various Sites – Door Entry Systems Group 6 Project No 23127- location is listed below (Contract”),**

The Scope of work to include Installation of AIPhone door entry intercom systems at various sites. Sites: Thornhill Elementary School, Oakland Academy of Knowledge, Lockwood Steam Academy, Lockwood CDC, & Kaiser Early Childhood Center.

**Engineer’s Estimate for each project is: \$140,000.00**  
**Please submit separately for each bid.**

**Project Manager** is Kyle Brower, who can be reached at: [kyle.brower@ousd.org](mailto:kyle.brower@ousd.org) or 510-459-1809.

The Contract Documents for each Contract, including the drawings and specifications, may now be obtained electronically from the Architect, who is

OUSD 955 High Street, Oakland, California,510-535-7044 .

The lowest bid for each Contract shall be determined on the amount of the base bid.

Each Contract *is not* subject to prequalification pursuant to Public Contract Code section 20111.6.

This Contract *is not* subject to the District’s Project Labor Agreement.

Contract Documents will be available for review on or after **November 13, 2023**, at **East Bay Blue Print, located at 1745 14<sup>th</sup> Avenue, Oakland, CA 94606**. All requests should be addressed Attention: Sandy Petty. Plans can be ordered by:

Ph: 510-261-2990 Fax: 510-261-6077 Email: [ebbp@eastbayblueprint.com](mailto:ebbp@eastbayblueprint.com), Attn: Sandy. Online using the Plan Command System at [www.eastbayblueprint.com](http://www.eastbayblueprint.com) or plans

can be delivered to a place of business, at requester's own expense. Payment for plan sets must be made with East Bay Blue Print and are **NON-REFUNDABLE**

In addition, Contract Documents are available for bidders' review at the following builders' exchanges:

Builder's Exchange of Alameda County  
McGraw Hill Construction Data  
San Francisco Builder's Exchange

Reed Construction Market Data  
Contra Costa Builder's Exchange  
Marin Builder's Exchange

Public works projects shall be subject to compliance monitoring and enforcement by the Department of Industrial Relations. For all projects over Twenty-Five Thousand Dollars (\$25,000), a contractor or subcontractor shall not be qualified to submit a bid or to be listed in a bid proposal subject to the requirements of Public Contract Code section 4104 unless currently registered and qualified under Labor Code section 1725.5 to perform public work as defined by Division 2, Part 7, Chapter 1 (§§1720 et seq.) of the Labor Code. For all projects over Twenty-Five Thousand Dollars (\$25,000), a contractor or subcontractor shall not be qualified to enter into, or engage in the performance of, any contract of public work (as defined by Division 2, Part 7, Chapter 1 (§§1720 et seq.) of the Labor Code) unless currently registered and qualified under Labor Code section 1725.5 to perform public work and proof of registration is provided.

The Contract Time for each Contract shall be as follows:

- For the **Various Sites – Door Entry Systems Group 5 Project No 23126**  
Contract, ninety (90) calendar days.
- For the **Various Sites – Door Entry Systems Group 6 Project No 23127**  
Contract, ninety (90) calendar days.

Liquidated damages for delay shall accrue. See Article III of the Agreement for details.

Bids must be sealed and filed at:

**Front Desk  
Facilities Planning & Management  
955 High Street  
Oakland, CA 94601**

on **November 23, 2023, before 2:00 p.m.** on the clock designated by the Owner or its representative as the bid clock. No bid will be accepted by the Owner after this time. Facsimile (FAX) copies of the bid will not be accepted. PLEASE NOTE: BID RESULTS WILL BE MADE AVAILABLE VIA EMAIL.

Mandatory pre-bid **site visit** will be held at the following date and time:

- For the **Various Sites – Door Entry Systems Group 5 Project No 23126** Contract, on **November 16, 2023 at 1:00 p.m.,** at Oakland Tech Upper Campus, 4351 Broadway, Oakland, California 94611
- For the **Various Sites – Door Entry Systems Group 6 Project No 23127** Contract, on **November 16, 2023 at 1:00 p.m.,** at Oakland Tech Upper Campus, 4351



Bidders not attending the site visit will be disqualified.

For each Contract on which a bid is submitted, the bid must be accompanied by a bidder's bond, cashier's check, or certified check for at least ten percent (10%) of the amount of the base bid and made payable to the Owner, as detailed in the Contract Documents.

Pursuant to the Contract Documents, the successful bidder on each Contract will be required to furnish a Payment (Labor and Material) Bond in the amount of one hundred percent (100%) of the Contract Sum, and a Faithful Performance Bond in the amount of one hundred percent (100%) of the Contract Sum.

The successful bidder on each Contract will be allowed to substitute securities or establish an escrow in lieu of retainage, pursuant to Public Contract Code Section 22300, and as described in the Agreement Between Owner and Contractor and General Conditions.

The Owner will not consider or accept any bids from contractors who are not licensed to do business in the State of California, in accordance with the California Public Contract Code, providing for the licensing of contractors. In accordance with Section 3300 of said Code, the bidder for each Contract shall have a Class a **C7 – Low Voltage Systems and/or C10 – Electrical Contractors license and Milestone Certification** license at the time of award and shall maintain that license in good standing through Completion of the Contract and all applicable warranty periods. For all projects over Twenty-Five Thousand Dollars (\$25,000), the bidder shall state the public works contractor registration number on the Designation of Subcontractors form for each subcontractor performing more than one-half of one percent (0.5%) of the bidder's total bid.

The Director of Industrial Relations of the State of California, in the manner provided by law, has ascertained the general prevailing rate of per diem wages and rate for legal holidays and overtime work. On each Contract, the Contractor must pay for any labor therein described or classified in an amount not less than the rates specified. Copies of the required rates are on file at the Owner's business office and are available on request.

Advertisement (Public Contract Code §22034(a)):

Date of Mail, Fax, or E-Mail to Contractors on List **November 9, 2023**

**INSTRUCTIONS TO BIDDERS**  
**DOCUMENT 00 11 12**

The Various Sites – Door Entry Systems Group 5 & 6 Contracts at Multiple Sites for the  
Oakland Unified School District

**MULTIPLE CONTRACTS FOR MULTIPLE SITES:**

Bidders may submit a bid for one or more of the Contracts specified in the Notice to Bidders and Bid Form. However, for each bid on a particular Contract, bidder must submit a complete set of bid documents (see BIDS, below).

**SECURING DOCUMENTS:**

The Contract Documents for each Contract, including the Drawings and Specifications, are available at East Bay BluePrint, Located at 1745 14<sup>th</sup> Avenue, Oakland, CA 94606. All requests should be addressed Attention: Sandy Petty. Plans can be ordered by:

Ph: 510-261-2990 Fax: 510-261-6077 Email: [ebbp@eastbayblueprint.com](mailto:ebbp@eastbayblueprint.com), Attn: Sandy. Online using the Plan Command System at [www.eastbayblueprint.com](http://www.eastbayblueprint.com) or plans can be delivered to a place of business, at requester's own expense. Payment for plan sets must be made with East Bay Blue Print and are NON-REFUNDABLE  
In addition, Contract Documents are available for bidders' review at the following builders' exchanges:

Builder's Exchange of Alameda County  
McGraw Hill Construction Data  
San Francisco Builder's Exchange

Reed Construction Market Data  
Contra Costa Builder's Exchange  
Marin Builder's Exchange

**PREQUALIFICATION:**

None of these Contracts are subject to prequalification.

**PROJECT LABOR AGREEMENT: [Not Used]**

**LOCAL, SMALL LOCAL, AND SMALL LOCAL RESIDENT BUSINESS ENTERPRISE PROGRAM: [Not Used]**

**RETENTION:** For all of the other Contracts, the Owner will withhold retention of 5% from all progress payments.

**REGISTRATION:**

OAKLAND UNIFIED SCHOOL DISTRICT  
VARIOUS SITES  
DOOR ENTRY SYSTEMS GROUP 5 & 6  
PROJECT NO 23126 & 23127

INSTRUCTIONS TO BIDDERS  
DOCUMENT 00 11 12

For all projects over Twenty-Five Thousand Dollars (\$25,000), the Owner shall not accept any bid or enter into any contract without proof of the bidder’s current registration to perform public work under Labor Code section 1725.5.

For all projects over Twenty-Five Thousand Dollars (\$25,000), the bidder shall not accept any subbid or enter into any subcontract without proof of the subcontractor’s current registration to perform public work under Labor Code section 1725.5.

**PRE-BID CONFERENCES, SITE VISITS, OR MEETINGS:**

Mandatory pre-bid conferences, site visits, or meetings will be held as described in the Notice to Bidders.

**BUILDERS RISK COVERAGE:**

For the purpose of builders risk coverage (see General Conditions Article 11), each *Contract* is being solely funded by revenue bonds.

**PROJECT LABOR AGREEMENT:** [Not Used]

**USE OF FEDERAL FUNDS:**

No federal funds are being used by Owner for any of the Contracts.

**PROPRIETARY SYSTEMS, EQUIPMENT, MATERIALS & VENDORS**

Pursuant to Board of Education Resolution No. 2122-0152 in compliance with Public Contract Code §3400(c)(2), Oakland Unified School District designates and approves the following proprietary systems, equipment, materials and vendors for which there are no compatible “or equal” substitutions suggested in any of the technical specification sections:

▪ iPhone	IP Series door entry systems
▪ Alerton	Energy Management Systems (EMCS)
▪ Avaya	Phone System, IP-500
▪ BLUM	Casework hinges
▪ Bosch/Radionics	Intrusion System, B9512G
▪ Chicago	Faucets
▪ Cisco	Phone systems - 7841 (Classrooms), 8841/8851 (Offices), 8865 (Video enabled for use with iPhone door entry systems and ADA solutions)

{SR789985}2

▪ Cisco	4500X Network Switches
▪ Falcon	Alternate manufacturer of door closers
▪ Honeywell	Thermostats - VP525A & TP970 Thermostat Modernization Kit with Universal Adaptor
▪ Ives	Door hardware, continuous & butt hinges, coordinators, flush bolts, door stops and holders, kick plates, mop plates, push/pul plates, latch protectors, door silencers
▪ Milestone	XProtect Pro CCTV systems
▪ National Guard Products	Door thresholds, door smoke seal, weatherstrip, door sweeps, astragals, mullion seals, drip guards
▪ Norton	Door closers
▪ Rauland	Clock, Bell, Speaker Systems - Telecenter TCU
▪ Schlage	Door hardware, key system & cylindrical locks
▪ Simplex (JCI)	Fire Alarm Systems, 4100ES
▪ Sloan	Flush Valves, Royal Flushometer
▪ SofTILE	Soft surface pad surfacing
▪ Von Duprin	Door hardware, exit devices

**BIDS:**

Each separate bid on one of the Contracts shall be made in accordance with the following instructions:

1. Facsimile, e-mail, or other electronic copies of the Bid Form and other bid documents will not be accepted; only hard copies will be accepted. Bids shall be made on the Bid Form included in the bid package provided by Owner. Bids not made on the proper Bid Form shall be disregarded.
2. No bid for a Contract will be considered which makes exceptions, changes, or in any manner makes reservations to the terms of the drawings or specifications. If prequalification is required for this Contract, no bid will be accepted from a contractor that has not been prequalified.
3. Questions regarding documents, discrepancies, omissions, or doubt as to meanings shall be referred immediately to the Architect who will send written instructions clarifying such questions to each bidder. Oral responses will not be binding on the Owner or Architect or any Construction Manager.
4. Signatures:

- A. The bid form must give the full business address of the bidder and be signed by bidder. Bids by partnerships must furnish the full name of all partners and must be signed in the partnership name by a general partner with authority to bind the partnership in such matters, followed by the signature and designation of the person signing. The name of the person signing shall also be typed or printed below the signature. Bids by corporations must be signed with the legal name of the corporation, followed by the name of the state of incorporation and by the signature and designation of the chairman of the board, president or any vice president, and then followed by a second signature by the secretary, assistant secretary, the chief financial officer or assistant treasurer. All persons signing must be authorized to bind the corporation in the matter. The name of each person signing shall also be typed or printed below the signature. Satisfactory evidence of the authority of the officers signing on behalf of a corporation shall be furnished with the bid.
  - B. The signatures on the Bid Form and other bid documents must be either (1) original longhand signatures in permanent blue ink, or (2) electronic signatures (including but not limited to digital signatures). In the event that the bidder submits the proposal with an electronic signature, the bidder, by submission of the bid, shall be acknowledging and agreeing that the electronic signature shall have the same legal effect as an original longhand signature, and that District agrees that the electronic signature shall have the same legal effect as an original signature
5. Pursuant to the provisions of Sections 4100 to 4114, inclusive, of the Public Contract Code of the State of California, which are hereby incorporated and made a part hereof and these Instructions to Bidders, every bidder shall set forth in its bid for a Contract (using the Owner's form for Designation of Subcontractors):
- A. The name and location of the place of business, the California contractor license number, and (for all projects over Twenty-Five Thousand Dollars (\$25,000)) the public works contractor registration number, of each subcontractor who will perform work or labor or render service to the bidder in or about the construction of the work or improvement of that Contract, or a subcontractor licensed by the State of California who, under subcontract to the bidder, specially fabricates and installs a portion of the Work or improvement according to detailed drawings contained in the plans and specifications, in an amount in excess of one-half (½) of one percent (1%) of the bidder's total bid for that Contract. An inadvertent error in listing a California contractor's license number shall not be grounds for filing a bid protest or for considering the bid nonresponsive if the bidder submits the corrected contractor's license number to the Owner

within 24 hours after the bid opening, or any continuation thereof, so long as the corrected contractor's license number corresponds to the submitted name and location for that subcontractor.

- B. The portion of the Work for each Contract which will be done by each such subcontractor. If the bidder fails to specify a subcontractor for any portion of the Work to be performed under the Contract in excess of one-half ( $\frac{1}{2}$ ) of one percent (1%) of the bidder's total bid, the bidder agrees to perform that portion itself. The successful bidder shall not, without the consent of the Owner:
- 1) Substitute any person as subcontractor in place of the subcontractor designated in the original bid.
  - 2) Permit any subcontract to be assigned or transferred or allow it to be performed by anyone other than the original subcontractor listed in the bid.
  - 3) Sublet or subcontract any portion of the Work in excess of one-half ( $\frac{1}{2}$ ) of one percent (1%) of the total bid as to which the original bid did not designate a subcontractor.
6. The Director of Industrial Relations of the State of California, in the manner provided by law, has ascertained the general prevailing rate of per diem wages and the rate for legal holidays and overtime work. For each Contract, the Contractor must pay for any labor therein described or classified in an amount not less than the rates specified. Copies of the required rates are on file at the Owner's business office and are available to any interested party on request.
7. All Bid Forms must be accompanied by a completed Bid Cover Sheet, bid security (see below), Designation of Subcontractors (see above), Noncollusion Declaration and Sufficient Funds Declaration (Labor Code § 2810) for each Contract on which a bid is submitted. Each bid on a Contract must be accompanied by an executed Fingerprinting Notice and Acknowledgment, Iran Contracting Act certification (if required by law; see the form), Site Visit Certification (if the pre-bid site visit was mandatory; see above), responses to the Contractor Questionnaire (if required; see Paragraph 13, below), the Local Business Participation Form, the Schedule Z Debarment Suspension Certification, and the DVBE certification and worksheet (if required; see Paragraph 10, below).
8. Each bid on a Contract must be accompanied by a separate certified check, cashier's check, cash, or bidder's bond for that Contract, for an amount not less than ten percent (10%) of the amount of the base bid on that Contract, made

- payable to the order of the Owner. If a bidder's bond accompanies the bid for a Contract, said bond shall be secured by an Admitted Surety (an insurance organization authorized by the Insurance Commissioner to transact business of insurance in the State of California during this calendar year). The surety insurer must, unless otherwise agreed to by Owner in writing, at the time of issuance of the bond, have a rating not lower than "A-" as rated by A.M. Best Company, Inc. or other independent rating companies. Owner reserves the right to approve or reject the surety insurer selected by Contractor and to require Contractor to obtain a bond from a surety insurer satisfactory to the Owner. Said check or bond for a bid on a Contract shall be given as a guarantee that the bidder will enter into that Contract if awarded the Work, and in case of refusal or failure to enter into that Contract, the check or bond, as the case may be, shall be payable to the Owner and retained as liquidated damages.
9. Bids shall be sealed and filed as indicated in the Notice to Bidders. Irrespective of how a bidder chooses to deliver the bid and other documents to the Owner, the bidder is responsible for ensuring that the bid and other documents are actually received at the location designated in the Contract Documents for receipt of the bid and other documents prior to the time for the bid opening. Bids and other documents for any reason not actually received at the designated location prior to the time for the bid opening shall not be opened or considered.
10. **THESE CONTRACTS ARE SUBJECT TO THE DVBE REQUIREMENTS OF EDUCATION CODE SECTION 17076.11.** If these contracts are subject to these requirements, then (a) a DVBE Certification must be submitted with each bid on a Contract, and (b) a DVBE Worksheet must be submitted with each bid on a Contract if Box D is checked on the first page of the DVBE Certification for that Contract.
11. Contractors on each Contract shall maintain their licenses in good standing through Completion of the Work and all applicable warranty periods. Owner shall reject any bid on a Contract as nonresponsive if bidder or any subcontractor is not licensed in good standing for the Work on that Contract from the time the bid is submitted to Owner up to award of that Contract, whether or not the bidder listed the subcontractor inadvertently, or if a listed subcontractor's license is suspended or expires prior to award of that Contract. Owner also reserves the right to reject any bid on a Contract as nonresponsive if a listed subcontractor's license is not in good standing to perform the work on that Contract for which it is listed from the time of submission of the bidder's bid to award of that Contract.
12. The Owner reserves the right to waive any irregularity or failure to comply with the Contract Documents, and to reject any or all bids.

13. No responses to a Contractor Questionnaire are required to be submitted with a bid on this Contract.
14. To summarize, in addition to submitting the executed bid form which will contain bids for as many Contracts as bidder wants, each bid for a Contract must include the following documents prepared for that Contract (for example, if Contractor is submitting a bid form with bids on two of the Contracts, then in addition to the bid form, all of the following documents must be separately prepared and submitted for each of the two Contracts [i.e., two forms of bid security, two Designation of Subcontractor forms, two Noncollusion Declarations, etc.]):
  - a. Bid cover sheet.
  - b. Bid form, including proof of signers' authority.
  - c. Bid security.
  - d. Designation of Subcontractors.
  - e. Noncollusion Declaration.
  - f. Sufficient Funds Declaration.
  - g. Fingerprinting Notice and Acknowledgement.
  - h. Iran Contracting Act Certification (if required; see the form).
  - i. Responses to Contractor Questionnaire (if required; see above).
  - j. Local Business Participation Form.[Not Used]
  - k. Schedule Z Debarment Certification.
  - l. Site Visit Certification (if required; see above).
  - m. DVBE Certification (if DVBE is required; see above).
  - n. DVBE Worksheet (if DVBE is required; see above).
  - o. Proof of Registration per Labor Code §1725.5.

As discussed below, the following documents must be submitted prior to award and within ten (10) days of issuance of the Notice of Intent to Award:

- p. Performance Bond.
- q. Payment Bond.
- r. Insurance Certificates.
- s. Letter of Assent to Project Labor Agreement.[Not Used]

As discussed below, the following documents must be submitted within ten (10) days after receipt of Notice of Award of the Contract or before commencement of the Work, whichever is earlier:

- t. Signed Agreement
- u. Drug-Free Workplace Certification.
- v. Student Contact Form (see Exhibit B to the Fingerprinting Notice and Acknowledgement Form).
- w. Additional Insured and Other Required Endorsements.

{SR789985}7



- x. Insurance Declaration Pages.
- y. ~~Buy American Certification.~~
- z. Bid Documentation to Be Held in Escrow.
- aa. Roof Project Certification (if required).
- bb. Workers' Compensation Certification.
- cc. Asbestos & Other Hazardous Materials Certification.
- dd. Lead-Based Materials Certification.
- ee. Prevailing Wage and Related Labor Requirements Certification.
- ff. Tobacco-Free Environment Certification.
- gg. Imported Materials Certification.
- hh. A schedule of values (see General Conditions §9.2.1.A).
- ii. A schedule of cash flow (see General Conditions §9.2.1.B).
- jj. Subcontractor information (see General Conditions §9.2.1.D).
- kk. A certified baseline schedule (within two weeks of award or before commencement of the work, whichever is earlier; see General Conditions §3.9.1).

#### **WITHDRAWAL OF BIDS:**

A bid for a Contract may be withdrawn by bidders prior to the time fixed for the submittal of bids or any authorized postponement thereof.

A successful bidder shall not be relieved of a bid on a Contract unless by consent of the Owner or bidder's recourse to Public Contract Code §5100 et seq.

Unless otherwise required by law, no bidder may withdraw its bid on a Contract for a period of ninety (90) days after the date set for the opening thereof or any extension thereof. The Owner reserves the right to take more than ninety (90) days to make a decision regarding the rejection of the bid or the award of the Contract.

#### **OPENING OF BIDS:**

Opening of bids in public shall be at Owner's discretion, as set forth in the Notice to Bidders.

#### **EXAMINATION OF CONTRACT DOCUMENTS AND SITE:**

Before submitting a bid on a Contract, bidders shall examine the drawings, read the specifications, the form of Agreement between Contractor and Owner, and the other Contract Documents. Bidders shall visit the site of the proposed Work in that Contract, examine the building, or buildings, if any, and any work that may have been done thereon. Bidders shall fully inform themselves of all conditions, in, at, and about the site, the building or buildings, if any, and any work that may have been done thereon.

Pursuant to Public Contract Code section 1104, (1) bidders for a Contract shall not be required to assume responsibility for the completeness and accuracy of architectural or engineering plans and specifications, except on clearly designated design build projects; (2) however, bidders shall be required to review architectural or engineering plans and specifications prior to submission of their bids and to report any errors and omissions to the Architect and Owner; and (3) the review shall be confined to the bidder's capacity as a bidder and not as a licensed design professional.

## **BID PROTESTS**

All bid protests regarding a Contract must comply with the following, or they shall be rejected as invalid:

1. The protest shall be in writing;
2. The protest shall be filed and received no later than 4:00 p.m. on the third (3<sup>rd</sup>) business day after the deadline for submittal of the bids;
3. The protest shall set forth in detail all grounds for the protest, including all facts, supporting documentation, legal authorities and arguments in support of the bid protest;
4. Before the bid protest deadline, the protesting party shall transmit the complete bid protest, including all documentation, to all other parties having a potential interest that may be adversely affected by the outcome of the protest, including but not limited to all other bidders who may have a reasonable prospect of losing or obtaining an award of the Contract depending on the outcome of the protest; and
5. All factual contentions must be supported by competent, admissible and credible evidence.

The procedures and time limits set forth in this section for bid protests are strictly construed and are protesting party's sole and exclusive remedy in the event of a bid protest for a Contract. Protesting party's failure to strictly comply with these procedures and time limits shall constitute a waiver of any right to further pursue the bid protest, including but not limited to the presentation of a Government Code claim or legal proceedings. Any matter not set forth in the protest, including any ground for the protest or any evidence supporting a ground for the protest, shall be deemed waived.

A protesting party regarding a Contract may not rely on the bid protest submitted by another protesting party on that or any other Contract, but must timely pursue its own bid protest for that Contract.

Owner shall review a bid protest for a Contract that was not rejected for failing to comply with the above procedures. Any final decision on such a bid protest shall be made by the Governing Board.

## **FORM OF AGREEMENT BETWEEN OWNER AND CONTRACTOR:**

{SR789985}9

The form of Agreement between Owner and Contractor which the successful bidder will be required to execute for a Contract, if awarded the Work, is a part of this Bid Package.

**ADDENDA OR BULLETINS:**

Any addenda or bulletins for a Contract, issued during the time of bidding, shall form a part of the drawings and specifications loaned to the bidder for the preparation of its bid on that Contract, shall be covered in the bid for that Contract, and shall be made a part of the Contract Documents for that Contract. All addenda or bulletins shall be signed by the Architect and approved by the Division of State Architect.

**EVIDENCE OF RESPONSIBILITY:**

Upon the request of Owner, a bidder on a Contract shall submit promptly to the Owner or its designee satisfactory evidence showing the bidder's financial resources, the bidder's experience in the type of work required by the Owner, the bidder's organization available for the performance of the Contract, and any other required evidence of the bidder's or its subcontractor's qualifications to perform the proposed Contract. The Owner may consider such evidence before making its decision awarding that Contract. Failure to submit evidence of the bidder's or its subcontractors' responsibility to perform that Contract may result in rejection of the bid.

**NOTICE OF INTENT TO AWARD, AND AWARD OF CONTRACT:**

Rejection of any or all bids, contracting work with whomever and in whatever manner, abandoning work entirely, and/or waiving any informality in receiving of bids are reserved as the rights of the Owner.

Upon issuance of a Notice of Intent to Award to the apparent low bidder, the apparent low bidder shall provide the documents required by such Notice within ten (10) days. These documents shall include, at a minimum, the performance and payment bonds, the insurance certificates required by the contract, and a letter of assent to the Project Labor Agreement. In addition, before a Contract is awarded, the Owner may, at its sole discretion, require from the potential Contractor on that Contract further evidence of the reasonable qualifications of such contractor to faithfully, capably, and reasonably perform that Contract and may consider such evidence before making its decision on the award of that Contract.

If awarded, the Contract shall be awarded to the lowest responsible and responsive bidder as indicated in the Notice to Bidders and as interpreted by the Owner under California law and as specified herein. Owner reserves the right, without any liability, to cancel the

award of any Contract for any reason at any time before the full execution of the Agreement between Owner and Contractor.

**NOTICE OF AWARD, AND EXECUTION OF AGREEMENT BETWEEN OWNER AND CONTRACTOR:**

Contractor shall sign and return the Agreement for a Contract within ten (10) days after mailing, faxing or delivery of the Notice of Award of Contract, or prior to the commencement of the Work, whichever is earlier. The Contractor shall sign the Agreement in as many originals as the Owner deems necessary. Within ten (10) days after mailing, faxing, or delivery of the Notice of Award of Contract, or prior to the commencement of the Work, whichever is earlier, the Contractor shall also submit to Owner the Contract additional insured and other endorsements, and declarations page; a Public Contract Code section 3006(a) Roof Project Certification (if required); a Drug-Free Workplace Certification; a Workers' Compensation Certification, a Buy American Certification, an Asbestos & Other Hazardous Materials Certification, a Tobacco-Free Environment Certification, an Imported Materials Certification, a Lead-Based Materials Certification, a Prevailing Wage and Related Labor Requirements Certification, bid documentation to be held in escrow, a Student Contact Form, a schedule of values (see General Conditions §9.2.1.A), a schedule of cash flow (see General Conditions §9.2.1.B), and subcontractor information (see General Conditions §9.2.1.D). Within two (2) weeks after award the Work, or prior to commencement of the Work, whichever is earlier, the Contractor shall also submit to Owner the certified baseline schedule (see General Conditions §3.9.1). If the Contractor does not comply with this paragraph, Owner may revoke and/or cancel the award to the Contractor, award the Contract to the next lowest bidder, and pursue the low bidder and bid bond for damages, or may otherwise proceed as allowed by law. A Roof Project Certification is not required if (1) the Owner has ADA (average daily attendance) of 2,500 or less, or (2) the Work involves repair of 25% or less of the roof, or costs \$21,000 or less.

**CONTRACT BONDS:**

As required by the Contract Documents, two bonds, as itemized below and in the forms presented in these Contract Documents, shall be furnished by the Contractor for each Contract. They shall be in the form of surety bonds issued by Admitted Surety insurers (an insurance organization authorized by the Insurance Commissioner to transact business of insurance in the State of California during this calendar year). The surety insurers must, unless otherwise agreed to by Owner in writing, at the time of issuance of the bond, have a rating not lower than "A-" as rated by A.M. Best Company, Inc. or other independent rating companies. Owner reserves the right to approve or reject the surety insurers selected by Contractor and to require Contractor to obtain bonds from surety insurers satisfactory to the Owner.

**Performance Bond** in the amount of one hundred percent (100%) of the Contract Sum to insure Owner during construction, and for one year after Completion and during any warranty or guaranty period, against faulty or improper materials or workmanship and to assure Owner of full and prompt performance of the Contract.

**Payment Bond** (Labor and Material) in the amount of one hundred percent (100%) of the Contract Sum in accordance with the laws of the State of California to secure payment of any and all claims for labor and materials used or consumed in performance of this Contract.

**REQUESTS FOR SUBSTITUTION OF MATERIALS PRIOR TO BIDDING:**

The Contractor must ensure that requested substitutions by the Contractor or its subcontractors for a Contract are submitted to the Owner and Architect a minimum of ten (10) calendar days prior to the bid opening for that Contract for review and possible approval of any equipment or materials thought to be equal to or better than those specified in the drawings or specifications. An addendum for a Contract may be issued by Owner prior to bid opening, including all equipment and materials deemed equivalent to those specified and approved by the Architect. Requests for substitution shall include comparative spec-data of the specified equipment or material and the proposed substitution as set forth in the Contract Documents; requests without this information will be automatically rejected. Requests for substitution shall be submitted on the Owner's form, which Owner shall provide upon request. Requests for substitution shall conform to the Contract Documents, including but not limited to General Conditions section 3.11.4.3.

**PAYMENTS:**

Payments to the Contractor on account of a Contract shall be made in accordance with the terms of the Contract Documents for that Contract.

**TAXES:**

The Owner is generally exempt from payment of Federal Excise Tax on materials. The Owner will furnish exemption certificates to the Contractor to be used to obtain materials for a Contract ordinarily subject to Federal Excise Tax without payment of the tax. Bidder shall deduct Federal Excise Taxes from their bid prices before submitting a bid on a Contract, so that such taxes will not be included in the Contract Sum for that Contract.

**EARLY TERMINATION:**

Notwithstanding any provision herein to the contrary, if for any fiscal year of a Contract the governing body of the Owner fails to appropriate or allocate funds for future periodic payments under that Contract after exercising reasonable efforts to do so, the Owner may

upon thirty (30) days' notice, order Work on the Contract to cease. The Owner will remain obligated to pay for the Work already performed but shall not be obligated to pay the balance remaining unpaid beyond the fiscal period for which funds have been appropriated or allocated and for which the Work has not been done.

**TIME OF COMPLETION AND LIQUIDATED DAMAGES:**

The Contract Time for the Contracts shall be as stated in the Notice to Bidders. See Article III of the Agreement for details about the Contract Time and any milestone deadlines.

Liquidated damages for delay in Completion of the Work for a Contract within the Contract Time, or for delay in completion of a specified portion of the Work for a Contract by a milestone deadline, will accrue and may be assessed as provided in the Contract Documents for that Contract, including Article III of the Agreement and Article 8 of the General Conditions.

**COVID-19**

During the Work on a Contract, the Contractor shall ensure that all Work, including but not limited to Work performed by Subcontractors, is performed in compliance with all applicable legal, contractual, and local government requirements related to the novel coronavirus and COVID-19, including “social distancing,” masks, and hygiene as may be ordered by the State or local authorities and as may be directed in the Contract Documents for that Contract. Each bidder on a Contract must include in its bid for that Contract all costs related to these requirements in effect at the time of bidding. If additional COVID-19 requirements are imposed for a Contract after the bid and the Contractor believes that it is entitled to additional time or money, it must timely submit proper requests pursuant to the Contract Documents for that Contract.

**PLEASE SUBMIT A SEPARATE CONTRACT and BONDS FOR EACH PROJECT AS FOLLOWS:**

Various Sites Door Entry Systems Group 5 Project No 23126

Various Sites Door Entry Systems Group 6 Project No 23127

**SUFFICIENT FUNDS DECLARATION**  
**DOCUMENT 00 11 13**  
**(Labor Code section 2810)**

To Be Executed by Bidder and Submitted with Bid

Owner:           Oakland Unified School District  
Contract:        Various Sites Door Entry Systems Group 5 & 6

I, \_\_\_\_\_, declare that I am the \_\_\_\_\_  
[insert title] of \_\_\_\_\_, the entity making and submitting the bid for  
the above Project that accompanies this Declaration, and that such bid includes sufficient  
funds to permit \_\_\_\_\_ [insert name of entity] to comply with all local,  
state or federal labor laws or regulations during the Project, including payment of  
prevailing wage, and that \_\_\_\_\_ [insert name of entity] will comply with  
the provisions of Labor Code section 2810(d) if awarded the Contract.

I declare under penalty of perjury under the laws of the State of California that the  
foregoing is true and correct and executed on \_\_\_\_\_ 20 \_\_, at \_\_\_\_\_ [city],  
\_\_\_\_\_ [state].

Date: \_\_\_\_\_

\_\_\_\_\_  
Signature  
Print Name: \_\_\_\_\_  
Print Title: \_\_\_\_\_

**QUESTIONNAIRE REGARDING**  
**QUALIFICATIONS AND EXPERIENCE**  
**DOCUMENT 00 21 00**

The Various Sites Door Entry Systems Group 5 & 6 Contract for the  
Oakland Unified School District (“Owner”)

With its bid on this contract, each bidder must submit complete answers and information in response to the following questions and requests. Attach as many pages of explanation and documents as necessary.

1. If any information or answer submitted with your most recent prequalification application to the Owner is no longer complete or accurate, provide all additional information so that the information or answer is complete and accurate. (If you need a copy of your most recent prequalification application, please contact the Owner.)

2. Identify all public works contracts on which you have performed work over the last 5 years where you entered a direct (i.e., prime) contract with the public agency owner of the project, and provide the following information for each contract (but information already provided in your most recent prequalification application or in response to Question #1 above need not be repeated here):

- a. The public agency owner, its design professional, and its construction manager.
- b. The contact persons at the owner, the design professional, and the construction manager.
- c. The name of project.
- d. The delivery method of the project (e.g., single prime competitive bidding, multiple prime competitive bidding, design-build, lease-leaseback, etc.).
- e. The date of the owner’s award of the contract to you.
- f. The original scope of work in the contract.
- g. The original contract price.
- h. The original contract time for performance.
- i. Any claims against the owner presented by you, including the amount claimed and each basis of the claim.
- j. Any lawsuit or cross-complaint against the owner filed by you, including the amount claimed, each basis of the lawsuit or cross-complaint, the name of the court, and the case number.
- k. Any demand for arbitration given to the owner by you, including the amount claimed and each basis of the demand for arbitration.
- l. Any amounts withheld by owner from progress payments to you or release of retention to you, including the amount withheld and the each basis for the withholding.



- m. Any lawsuit or cross-complaint filed by the owner against you, including the amount claimed, the name of the court, and the case number.
- n. Any demand for arbitration given by the owner to you, including the amount claimed and each basis of the demand for arbitration.
- o. A copy of any settlement agreement, change order, or other document (including e-mail or letter) that resolved one or more of the above claims, lawsuits, cross-complaints, or arbitrations.
- p. The total of payments you received from the public agency owner for the project, including all settlements, change orders, awards, or judgments; and the total of any payments from you to the public agency owner for the project, including all settlements, change orders, awards, or judgments.

3. Of the contracts identified in response to Question #2, above, identify each contract where your work was not completed by the original completion deadline, including the following information for each such contract:

- a. Number of days from original completion deadline to full and final completion of your work on the project as required by the contract.
- b. All reasons for the delay in completion, including delay for which you were responsible.

4. Of the contracts identified in response to Question #2, above, identify each contract where a Civil Wage and Penalty Assessment (“CWPA”) or Determination of Civil Penalty (“DCP”) was issued by the Division of Labor Standards Enforcement against you or your subcontractors, including the following information for each such CWPA and DCP on that contract:

- a. Description of each CWPA and DCP, including the amount of any wages due or penalties assessed under each CWPA and DCP.
- b. A copy of each CWPA and DCP.
- c. Reasons for the issuance of each CWPA and DCP.

5. Of the contracts identified in response to Question #2, above, identify each contract where the work concerned including the following information for each such contract:

- a. \_\_\_\_\_
- b. \_\_\_\_\_

6. Of the contracts identified in response to Question #2, above, identify each contract where the work concerned including the following information for each such contract:

- a. \_\_\_\_\_
- b. \_\_\_\_\_

7. Of the contracts identified in response to Question #2, above, identify each contract where the public agency owner or one or more of its representatives for the contract are contractually or legally prohibited from speaking to the Owner about any aspects of the contract, including the following information for each such contract:

- a. The aspect or aspects of the contract the public agency owner or its representative is prohibited from discussing with the Owner.
- b. The details of the contractual or legal prohibition that prevents the public agency owner or its representative from speaking with the Owner about an aspect of the contract.
- c. Whether you agree to waive the above contractual or legal prohibition so that the public agency owner or its representative may speak with the Owner about all aspects of the contract, including your performance of the work under the contract and any disputes that occurred during the contract.

**EXISTING CONDITIONS**  
**DOCUMENT 00 21 01**

**1. Summary**

The attached documents describe existing conditions at or near the Project, and use of information available regarding existing conditions. These documents are **not** part of the Contract Documents. See General Conditions for definition(s) of terms used herein.

**2. Reports and Information on Existing Conditions**

- a. Documents providing a general description of the Site and conditions of the Work may have been collected by Oakland Unified School District (“District“), its consultants, contractors, and tenants. These documents may, but are not required to, include previous contracts, contract specifications, tenant improvement contracts, as-built drawings, utility drawings, and information regarding underground facilities.
- b. Information regarding existing conditions may be inspected at the District offices or the Construction Manager’s offices, if any, and copies may be obtained at cost of reproduction and handling upon Bidder's agreement to pay for such copies. These reports, documents, and other information are **not** part of the Contract Documents. These reports, documents, and other information do **not** excuse Contractor from fulfilling Contractor’s obligation to independently investigate any or all existing conditions or from using reasonable prudent measures to avoid damaging existing improvements.
- c. Information regarding existing conditions may also be included in the Project Manual, but shall **not** be considered part of the Contract Documents.
- d. Prior to commencing this Work, Contractor and the District’s representative shall survey the Site to document the condition of the Site. Contractor will record the survey in digital videotape format and provide an electronic copy to the District within fourteen (14) days of the survey.
- e. Contractor may also document any pre-existing conditions in writing, provided that both the Contractor and the District’s representative agree on said conditions and sign a memorandum documenting the same.
- f. The reports and other data or information regarding existing conditions and underground facilities at or contiguous to the Project are the following:
  - 1) Original Construction Drawings.
  - 2) Survey of Site.
  - 3) Geotechnical Report(s).
  - 4) Hazardous Material Report(s).

5) Videotaped Survey(s).

### **3. Use of Information**

- a. Information regarding existing conditions was obtained only for use of District and its consultants, contractors, and tenants for planning and design and is **not** part of the Contract Documents.
- b. District does not warrant, and makes no representation regarding, the accuracy or thoroughness of any information regarding existing conditions. Bidder represents and agrees that in submitting a bid it is not relying on any information regarding existing conditions supplied by District.
- c. Under no circumstances shall District be deemed to warrant or represent existing above-ground conditions, as-built conditions, or other actual conditions, verifiable by independent investigation. These conditions are verifiable by Bidder by the performance of its own independent investigation that Bidder must perform as a condition to bidding and Bidder should not and shall not rely on this information or any other information supplied by District regarding existing conditions.
- d. Any information shown or indicated in the reports and other data supplied herein with respect to existing underground facilities at or contiguous to the Project may be based upon information and data furnished to District by the District's employees and/or consultants or builders of such underground facilities or others. District does not assume responsibility for the completeness of this information, and Bidder is solely responsible for any interpretation or conclusion drawn from this information.
- e. District shall be responsible only for the general accuracy of information regarding underground facilities, and only for those underground facilities that are owned by District, and only where Bidder has conducted the independent investigation required of it pursuant to the Instructions to Bidders, and discrepancies are not apparent.

### **4. Investigations/Site Examinations**

- a. Before submitting a bid, each Bidder is responsible for conducting or obtaining any additional or supplementary examinations, investigations, explorations, tests, studies, and data concerning conditions (surface, subsurface, and underground facilities) at or contiguous to the Site or otherwise, that may affect cost, progress, performance, or furnishing of Work or that relate to any aspect of the means, methods, techniques, sequences, or procedures of construction to be employed by Bidder and safety precautions and programs incident thereto or that Bidder deems necessary to determine its Bid for performing and furnishing the Work in accordance with the time, price, and other terms and conditions of Contract Documents.
- b. On request, District will provide each Bidder access to the Site to conduct such examinations, investigations, explorations, tests, and studies, as each Bidder deems

necessary for submission of a bid. Bidders must fill all holes and clean up and restore the Site to its former condition upon completion of its explorations, investigations, tests, and studies. Such investigations and Site examinations may be performed during any and all Site visits indicated in the Notice to Bidders and only under the provisions of the Contract Documents, including, but not limited to, proof of insurance and obligation to indemnify against claims arising from such work, and District's prior approval.

END OF DOCUMENT

**GEOTECHNICAL DATA**  
**DOCUMENT 00 21 02**

**1. Summary**

The attached one or more geotechnical documents describe geotechnical data at or near the Project that is in the District's possession available for Contractor's review, and use of data resulting from various investigations. The attached documents are part of the Contract Documents. See General Conditions for definition(s) of terms used herein.

**2. Geotechnical Reports**

- a. Geotechnical reports may have been prepared for and around the Site and/or in connection with the Work by soil investigation engineers hired by Oakland Unified School District ("District"), and its consultants, contractors, and tenants.
- b. Geotechnical reports may be inspected at the District offices or the Construction Manager's offices, if any, and copies may be obtained at cost of reproduction and handling upon Bidder's agreement to pay for such copies. These reports are part of the Contract Documents.
- c. The reports and drawings of physical conditions that may relate to the Project are the following:

Geotechnical Engineering and Geologic Hazards Study

**3. Use of Data**

- a. Geotechnical data were obtained only for use of District and its consultants, contractors, and tenants for planning and design and are a part of Contract Documents.
- b. Except as expressly set forth below, District does not warrant, and makes no representation regarding, the accuracy or thoroughness of any geotechnical data. Bidder represents and agrees that in submitting a bid it is not relying on any geotechnical data supplied by District, except as specifically allowed below.
- c. Under no circumstances shall District be deemed to make a warranty or representation of existing above ground conditions, as-built conditions, geotechnical conditions, or other actual conditions verifiable by independent investigation. These conditions are verifiable by Bidder by the performance of its own independent investigation that Bidder should perform as a condition to bidding and Bidder must not and shall not rely on information supplied by District.

#### **4. Limited Reliance Permitted on Certain Information**

- a. Reference is made herein for identification of:

Reports of explorations and tests of subsurface conditions at or contiguous to the Site that have been utilized by District in preparation of the Contract Documents.

Drawings of physical conditions in or relating to existing subsurface structures (except underground facilities) that are at or contiguous to the Site and have been utilized by District in preparation of the Contract Documents.

- b. Bidder may rely upon the general accuracy of the “technical data” contained in the reports and drawings identified above, but only insofar as it relates to subsurface conditions, provided Bidder has conducted the independent investigation required pursuant to Instructions to Bidders, and discrepancies are not apparent. The term “technical data” in the referenced reports and drawings shall be limited as follows:
- 1) The term “technical data” shall include actual reported depths, reported quantities, reported soil types, reported soil conditions, and reported material, equipment or structures that were encountered during subsurface exploration. The term “technical data” does not include, and Bidder may not rely upon, any other data, interpretations, opinions or information shown or indicated in such drawings or reports that otherwise relate to subsurface conditions or described structures.
  - 2) The term “technical data” shall not include the location of underground facilities.
  - 3) Bidder may not rely on the completeness of reports and drawings for the purposes of bidding or construction. Bidder may rely upon the general accuracy of the “technical data” contained in such reports or drawings.
  - 4) Bidder is solely responsible for any interpretation or conclusion drawn from any “technical data” or any other data, interpretations, opinions, or information provided in the identified reports and drawings.

#### **5. Investigations/Site Examinations**

- a. Before submitting a bid, each Bidder is responsible for conducting or obtaining any additional or supplementary examinations, investigations, explorations, tests, studies, and data concerning conditions (surface, subsurface, and underground facilities) at or contiguous to the Site or otherwise, that may affect cost, progress, performance, or furnishing of Work or that relate to any aspect of the means, methods, techniques, sequences, or procedures of construction to be employed by Bidder and safety precautions and programs incident thereto or that Bidder deems necessary to determine its Bid for performing and furnishing the Work in accordance with the time, price, and other terms and conditions of Contract Documents.

- b. On request, District will provide each Bidder access to the Site to conduct such examinations, investigations, explorations, tests, and studies, as each Bidder deems necessary for submission of a bid. Bidders must fill all holes and clean up and restore the Site to its former condition upon completion of its explorations, investigations, tests, and studies. Such investigations and Site examinations may be performed during any and all Site visits indicated in the Notice to Bidders and only under the provisions of the Contract Documents, including, but not limited to, proof of insurance and obligation to indemnify against claims arising from such work, and District's prior approval.

END OF DOCUMENT



**BID COVER SHEET**  
**DOCUMENT 00 31 00**

OAKLAND UNIFIED SCHOOL DISTRICT  
Division of Facilities Planning and Management  
955 High Street  
Oakland, CA 94601

**BIDS MUST BE SEALED AND SUBMITTED TO:**

FRONT DESK  
955 HIGH STREET  
OAKLAND, CA 94601

**THIS SHEET MUST BE ATTACHED TO THE FRONT OF YOUR BID ENVELOPE**

**PLEASE NOTE: BID RESULTS WILL BE MADE AVAILABLE VIA EMAIL.**

**THANK YOU IN ADVANCE FOR YOUR PATIENCE AND COOPERATION.**

**Bid for: Various Sites Door Entry Systems Group 5 & 6**

**Project No.: 23126 & 23127**

**Bidder:**

\_\_\_\_\_

**Please print full (Company Name, Address)**

\_\_\_\_\_

**Please provide both: (Phone, Fax)**

**Bids are due: November 23, 2023, at 2:00 p.m.**  
(Bid will not be considered if submitted after this date and time)

<p>TIME STAMP HERE:</p>          <p>RECEIVED BY:</p>
--

**BID FORM**  
**DOCUMENT 00 31 01**

The Various Sites Door Entry Systems Group 5 & 6 Contracts at Multiple Sites for the  
Oakland Unified School District

**OAKLAND UNIFIED SCHOOL DISTRICT**  
955 High Street, Front Office desk  
Oakland, CALIFORNIA 94601

Dear Board Members:

The undersigned, doing business under the firm name of \_\_\_\_\_, hereby proposes and agrees to enter into a contract, with the Oakland Unified School District (“Owner”), to furnish any and all labor, materials, applicable taxes, equipment and services for the completion of Work as described hereinafter and in the Contract Documents for the following contracts on which the undersigned submits bids:

- **Various Sites – Door Entry Systems Group 5 Project No 23126 (the “Group 5 Contract”)**. The scope of work of the Group 5 Contract includes Installation of AIPhone door entry intercom systems at various sites. Sites: Oakland Tech Upper Campus, Montera Middle School, Jefferson CDC, Hillcrest Elementary School, & Bella Vista CDC.
  
- **Various Sites– Door Entry Systems Group 6 Project No 23127 (the “Group 6 Contract”)**. The scope of work of the Group 6 Contract includes Installation of AIPhone door entry intercom systems at various sites. Sites: Thornhill Elementary School, Oakland Academy of Knowledge, Lockwood Steam Academy, Lockwood CDC, & Kaiser Early Childhood Center.

The Contract Documents for the Contracts were prepared by Oakland Unified School District, Oakland, California.

**Bid Amounts (Base Bids):**

The undersigned submits one or more bids on the Contracts, as follows:

*For the Group 5 Contract:*

_____ Dollars <i>Bid Amount Without Contingency Allowance</i>	\$ _____
Fifteen Thousand Dollars <i>Total of Allowances (see Section IV of Agreement)</i>	\$15,000.00
_____ Dollars <i>Total Base Bid Amount</i>	\$ _____
<b>By submitting this bid, bidder acknowledges and agrees that the Total Base Bid Amount accounts for any and all allowances.</b>	

*For the Group 6 Contract:*

_____ Dollars <i>Bid Amount Without Contingency Allowance</i>	\$ _____
Fourteen Thousand Dollars <i>Total of Allowances (see Section IV of Agreement)</i>	\$14,000.00
_____ Dollars <i>Total Base Bid Amount</i>	\$ _____
<b>By submitting this bid, bidder acknowledges and agrees that the Total Base Bid Amount accounts for any and all allowances.</b>	

**Miscellaneous:**

For each Contract, the low bid shall be determined as described in the Notice to Bidders.

For each Contract awarded to the undersigned, the undersigned shall, within ten (10) days after mailing, faxing, or delivering of the Notice of Award or prior to the commencement of the Work, whichever is earlier, execute and deliver an agreement in the form of agreement present in these Contract Documents and give Performance and Payment Bonds in accordance with the specifications and bid as accepted.

The undersigned declares that it has read and understands the Contract Documents for each Contract on which it has submitted a bid, including but not limited to the Notice to Bidders, the Instructions to Bidders, the Agreement, the General Conditions, the Drawings, the Specifications, and any Special Conditions.

The undersigned declares that it has read and understands the Contract Documents, including but not limited to the Notice to Bidders, the Instructions to Bidders, the Agreement, the General Conditions, the Drawings, the Specifications, and any Special Conditions.

The undersigned hereby designates as the office to which any Notice of Award of a Contract may be mailed, faxed, or delivered:

\_\_\_\_\_  
\_\_\_\_\_

Our Public Liability and Property Damage Insurance is placed with:

\_\_\_\_\_  
\_\_\_\_\_

Our Workers' Compensation Insurance is placed with:

\_\_\_\_\_  
\_\_\_\_\_

Circular letters, bulletins, addenda, etc., bound with the specifications or issued during the time of bidding are included in the undersigned's bid for each Contract, and, in Completing the Contract, they are to become a part thereof.

The receipt of the following addenda to the specifications is acknowledged:

Addendum No. \_\_\_\_\_ Date \_\_\_\_\_  
Addendum No. \_\_\_\_\_ Date \_\_\_\_\_  
Addendum No. \_\_\_\_\_ Date \_\_\_\_\_

Addendum No. \_\_\_\_\_ Date \_\_\_\_\_  
Addendum No. \_\_\_\_\_ Date \_\_\_\_\_  
Addendum No. \_\_\_\_\_ Date \_\_\_\_\_

A bid for any Contract above may be withdrawn in writing at any time prior to the scheduled time for the opening of bids, including any authorized postponement thereof.

A bidder shall not submit this bid form unless the bidder's California contractor's license number appears clearly on it, the license expiration date and class are stated, and the bid form contains a statement that the representations made therein are made under penalty of perjury. Any bid submitted by a contractor who is not licensed pursuant to Business and Professions Code section 7028.15 shall be considered nonresponsive and shall be rejected. Any bid not containing the above information may be considered nonresponsive and may be rejected.

Proof of Bidder's registration per Labor Code §1725.5 must be submitted with this bid form.

**NOTE:** This bid form must give the full business address of the bidder and be signed by bidder with bidder's usual signature. Partnerships must furnish the full name of all partners and must be signed in the partnership name by a general partner with authority to bind the partnership in such matters, followed by the signature and designation of the person signing. The name of the person signing shall also be typed or printed below the signature. Corporations must sign with the legal name of the corporation, followed by the name of the state of incorporation and by the signature and designation of the chairman of the board, president or any vice president, and then followed by a second signature by the secretary, assistant secretary, the chief financial officer or assistant treasurer. All persons signing must be authorized to bind the corporation in the matter. The name of each person signing shall also be typed or printed below the signature. Satisfactory evidence of the authority of the officers signing on behalf of a corporation shall be furnished with the bid.

The undersigned declares under penalty of perjury under the laws of the State of California that the representations made in this bid are true and correct.

Name of Company as Licensed in California: \_\_\_\_\_

Business Address: \_\_\_\_\_

Telephone Number: \_\_\_\_\_

California Contractor License No.: \_\_\_\_\_

Class and Expiration Date: \_\_\_\_\_

Public Works Contractor Registration No.: \_\_\_\_\_

State of Incorporation, if Applicable: \_\_\_\_\_

INDIVIDUAL:

Dated: \_\_\_\_\_, 20\_\_

\_\_\_\_\_  
\_\_\_\_\_  
\_\_\_\_\_ (Name)

PARTNERSHIP:

Evidence of authority to bind partnership is attached.

Dated: \_\_\_\_\_, 20\_\_

\_\_\_\_\_  
\_\_\_\_\_  
\_\_\_\_\_ (Name)  
General Partner

CORPORATION:

Evidence of authority to bind corporation is attached.

Dated: \_\_\_\_\_, 20\_\_

\_\_\_\_\_  
\_\_\_\_\_  
\_\_\_\_\_ (Name)  
\_\_\_\_\_ (Chairman, Pres., or Vice-Pres.)

\_\_\_\_\_  
\_\_\_\_\_  
\_\_\_\_\_ (Name)  
\_\_\_\_\_ (Secretary, Asst. Secretary, CFO, or Asst. Treasurer)

**BID BOND**  
**DOCUMENT 00 40 00**

Bond Number: \_\_\_\_\_

KNOW ALL MEN BY THESE PRESENTS that we the undersigned \_\_\_\_\_ as Principal and \_\_\_\_\_ as Surety, are hereby held and firmly bound unto the Oakland Unified School District (“Owner”) in the sum of \_\_\_\_\_ Dollars (\$) \_\_\_\_\_ for payment of which sum, well and truly to be made, we hereby jointly and severally bind ourselves, our heirs, executors, administrators, successors and assigns.

The condition of the above obligation is such that whereas the Principal has submitted to the Owner a certain bid, attached hereto and hereby made a part hereof, to enter into a Contract in writing for the construction of \_\_\_\_\_ in strict accordance with Contract Documents.

NOW, THEREFORE,

a. If said bid shall be rejected, or, in the alternative;

b. If said bid shall be accepted and the Principal shall execute and deliver a contract in the form of agreement attached hereto and shall execute and deliver Performance and Payment Bonds in the forms attached hereto (all properly completed in accordance with said bid), and shall in all other respects perform the agreement created by the acceptance of said bid;

Then this obligation shall be void, otherwise the same shall remain in full force and effect, it being expressly understood and agreed that the liability of the Surety for any and all default of the Principal hereunder shall be the amount of this obligation as herein stated.

Surety, for value received, hereby stipulates and agrees that no change, extension of time, alteration or addition to the terms of the Contract on the call for bids, or to the Work to be performed hereunder, or the specifications accompanying the same, shall in any way affect its obligation under this bond, and it does hereby waive notice of any such change, extension of time, alteration or addition to the terms of said Contract or the call for bids, or to the Work, or to the specifications.

{SR798944} 1

IN WITNESS WHEREOF, the above-bounden parties have executed this instrument under several seals this \_\_\_\_ day of \_\_\_\_\_, \_\_\_\_\_, the name and corporate party being hereto affixed and these presents duly signed by its

undersigned representative, pursuant to authority of its governing body. In the presence of:

(Notary Seal)

\_\_\_\_\_  
(Principal)

\_\_\_\_\_  
(Business Address)

\_\_\_\_\_  
(Corporate Surety)

\_\_\_\_\_  
Business Address)

By: \_\_\_\_\_

\_\_\_\_\_

The rate or premium of this bond is \_\_\_\_\_ per thousand, the total amount of premium charged, \$\_\_\_\_\_.

(The above must be filled in by Corporate Surety).

{SR798944}2



**DESIGNATION OF SUBCONTRACTORS**  
**DOCUMENT 00 40 01**

PROJECT: \_\_\_\_\_ (Project Name)

PROJECT NO: \_\_\_\_\_ BIDDER'S NAME \_\_\_\_\_

DIR 10 Digit Registration No: \_\_\_\_\_

Each bidder shall set forth below the name and the location of the place of business of each subcontractor, and the California contractor license number and (for all projects over Twenty-Five Thousand Dollars (\$25,000)) public works contractor registration number of each subcontractor who will perform work or labor or render service to the Contractor in or about the construction of the Work or improvement, or to a subcontractor licensed by the State of California who, under subcontract to the Contractor, specially fabricates and installs a portion of the Work or improvement according to detailed drawings contained in the plans and specifications, in an amount in excess of one-half of 1 percent (0.5%) of the bidder's total bid, and the portion of the Work which will be done by each subcontractor. An inadvertent error in listing a California contractor's license number shall not be grounds for filing a bid protest or for considering the bid nonresponsive if the bidder submits the corrected contractor's license number to the Owner within 24 hours after the bid opening, or any continuation thereof, so long as the corrected contractor's license number corresponds to the submitted name and location for that subcontractor.

If the Contractor fails to specify a subcontractor for any portion of the Work to be performed under the Contract in excess of one-half of 1 percent (0.5%) of the Contractor's total bid, the Contractor shall be deemed to have agreed to perform such portion itself, and shall not be permitted to subcontract that portion of the Work except under the conditions hereinafter set forth.

Subletting or subcontracting of any portion of the Work as to which no subcontractor was designated in the original bid shall only be permitted in cases of public emergency or necessity, and then only after a finding reduced to writing as a public record of the legislative body of the Owner.

For all projects over Twenty-Five Thousand Dollars (\$25,000): For any bid proposal submitted, and for any contract for public work entered into, an inadvertent error in listing a subcontractor who is not registered under Labor Code section 1725.5 shall not be grounds for filing a bid protest or grounds for considering the bid nonresponsive, provided that either: the subcontractor is registered prior to the bid opening; or the subcontractor is registered and has paid the penalty registration fee specified in Labor Code section 1725.5(a)(2)(E), if applicable, within 24 hours after the bid opening; or the subcontractor is replaced by another registered subcontractor under Public

OAKLAND UNIFIED SCHOOL DISTRICT  
VARIOUS SITES  
DOOR ENTRY SYSTEMS GROUP 5 & 6  
PROJECT NO 23126 & 23127

DESIGNATION OF SUBCONTRACTORS  
DOCUMENT 00 40 01

{SR798843}

Contract Code section 4107. Failure of a listed subcontractor to be registered shall be grounds under Public Contract Code section 4107 for the Contractor, with the Owner’s consent, to substitute a registered subcontractor for the unregistered subcontractor.

Failure to provide this information in a legible manner may result in the rejection of an otherwise acceptable bid.

**NOTE:** *Reproduce page two of this section for additional listings needed beyond the length of this form.*

<b>Portion of Work (description)</b>	<b>Portion of Work (dollar amount)</b>	<b>Name of Subcontractor &amp; Phone No.</b>	<b>Location of Subcontractor</b>	<b>California Contractor License Number</b>	<b>Public Works Contractor Registration Number</b>

I am the authorized representative of the Bidder submitting this Designation of Subcontractors and I declare that each subcontractor listed holds a valid and current contractor license in good standing in California to perform the portion of work for which the subcontractor is listed.

I declare under penalty of perjury under the laws of the State of California that the foregoing is true and correct and that this declaration is executed on \_\_\_\_\_, 20\_\_\_, at \_\_\_\_\_ [city], \_\_\_\_\_ [state].

Signature: \_\_\_\_\_

Print Name: \_\_\_\_\_

Title: \_\_\_\_\_

**SITE VISIT CERTIFICATION**  
**DOCUMENT 00 40 02**

TO BE EXECUTED BY BIDDER AND SUBMITTED WITH BID  
IF SITE VISIT WAS MANDATORY

**PROJECT: Various Sites Door Entry Systems Group 5 & 6**

Check option that applies:

\_\_\_\_\_ I certify that I visited the Site of the proposed Work and became fully acquainted with the conditions relating to construction and labor. I fully understand the facilities, difficulties, and restrictions attending the execution of the Work under contract.

\_\_\_\_\_ I certify that \_\_\_\_\_ (Bidder's representative) visited the Site of the proposed Work and became fully acquainted with the conditions relating to construction and labor. The Bidder's representative fully understood the facilities, difficulties, and restrictions attending the execution of the Work under contract.

Bidder fully indemnifies the Oakland Unified School District, its Architect, its Engineer, its Construction Manager, and all of their respective officers, agents, employees, and consultants from any damage, or omissions, related to conditions that could have been identified during my visit and/or the Bidder's representative's visit to the Site.

I certify under penalty of perjury under the laws of the State of California that the foregoing is true and correct.

Date: \_\_\_\_\_

Proper Name of Bidder: \_\_\_\_\_

Signature: \_\_\_\_\_

Print Name: \_\_\_\_\_

Title: \_\_\_\_\_

END OF DOCUMENT

**NONCOLLUSION DECLARATION**  
**DOCUMENT 00 40 03**

Owner: Oakland Unified School District  
Contract: Various Sites Door Entry Systems Group 5 & 6

The undersigned declares:

I am the \_\_\_\_\_ of \_\_\_\_\_, the party making the foregoing bid or proposal ("Bid").

The Bid is not made in the interest of, or on behalf of, any undisclosed person, partnership, company, association, organization, or corporation. The Bid is genuine and not collusive or sham. The bidder or proposer ("Bidder") has not directly or indirectly induced or solicited any other Bidder to put in a false or sham bid. The Bidder has not directly or indirectly colluded, conspired, connived, or agreed with any Bidder or anyone else to put in a sham Bid, or to refrain from bidding or proposing ("Bidding"). The Bidder has not in any manner, directly or indirectly, sought by agreement, communication, or conference with anyone to fix the Bid price of the Bidder or any other Bidder, or to fix any overhead, profit, or cost element of the Bid price, or of that of any other Bidder. All statements contained in the Bid are true. The Bidder has not, directly or indirectly, submitted his or her Bid price or any breakdown thereof, or the contents thereof, or divulged information or data relative thereto, to any corporation, partnership, company, association, organization, Bid depository, or to any member or agent thereof to effectuate a collusive or sham Bid, and has not paid, and will not pay, any person or entity for such purpose.

Any person executing this declaration on behalf of a Bidder that is a corporation, partnership, joint venture, limited liability company, limited liability partnership, or any other entity, hereby represents that he or she has full power to execute, and does execute, this declaration on behalf of the Bidder.

I declare under penalty of perjury under the laws of the State of California that the foregoing is true and correct and that this declaration is executed on \_\_\_\_\_, 20\_\_, at \_\_\_\_\_ [city], \_\_\_\_\_ [state].

\_\_\_\_\_  
Signature

\_\_\_\_\_  
Print Name

OAKLAND UNIFIED SCHOOL DISTRICT  
VARIOUS SITES  
DOOR ENTRY SYSTEMS GROUP 5 & 6  
PROJECT NO 23126 & 23127

NON-COLLUSION  
DOCUMENT 00 40 03

**IRAN CONTRACTING ACT CERTIFICATION**  
**(Public Contract Code sections 2202-2208)**  
**DOCUMENT 00 40 04**  
**(To be Executed by Bidder and Submitted With Bid)**

As required by Public Contract Code (“PCC”) section 2204 for contracts of \$1,000,000 or more, please insert bidder’s or financial institution’s name and Federal ID Number (if available) and complete **one** of the options below. Please note that California law establishes penalties for providing false certifications, including civil penalties equal to the greater of \$250,000 or twice the amount of the contract for which the false certification was made; contract termination; and three-year ineligibility to bid on contracts. (PCC §2205.)

**OPTION #1 - CERTIFICATION**

I, the official named below, certify I am duly authorized to execute this certification on behalf of the bidder/financial institution identified below, and the bidder/financial institution identified below is **not** on the current list of persons engaged in investment activities in Iran created by California Department of General Services (“DGS”) and is not a financial institution extending twenty million dollars (\$20,000,000) or more in credit to another person/bidder, for 45 days or more, if that other person/bidder will use the credit to provide goods or services in the energy sector in Iran and is identified on the current list of persons engaged in investment activities in Iran created by DGS. (PCC §2204(a).)

<i>Bidder Name/Financial Institution (Printed)</i>	<i>Federal ID Number (or n/a)</i>
<i>By (Authorized Signature)</i>	
<i>Printed Name and Title of Person Signing</i>	
<i>Date Executed</i>	<i>Executed in</i>

**OPTION #2 – EXEMPTION**

Pursuant to Public Contract Code sections 2203(c) and (d), a public entity may permit a bidder/financial institution engaged in investment activities in Iran, on a case-by-case basis, to be eligible for, or to bid on, submit a proposal for, or enters into or renews, a contract for goods and services. If you have obtained an exemption from the certification requirement under the Iran Contracting Act, please fill out the information below, and attach documentation demonstrating the exemption approval.

<i>Bidder Name/Financial Institution (Printed)</i>	<i>Federal ID Number (or n/a)</i>
<i>By (Authorized Signature)</i>	

*Printed Name and Title of Person Signing*

*Date Executed*

**OAKLAND UNIFIED SCHOOL DISTRICT  
VARIOUS SITES  
DOOR ENTRY SYSTEMS GROUP 5 & 6  
PROJECT NO 23126 & 23127**

**IRAN CONTRACTING  
DOCUMENT 00 40 04**

{SR798838}

**WORKERS' COMPENSATION CERTIFICATE**  
**DOCUMENT 00 40 05**

Labor Code Section 3700, in relevant part, provides:

"Every employer except the state shall secure the payment of compensation in one or more of the following ways:

(a) By being insured against liability to pay compensation in one or more insurers duly authorized to write compensation insurance in this state.

(b) By securing from the Director of Industrial Relations a certificate of consent to self-insure either as an individual employer or as one employer in a group of employers. Said certificate may be given upon furnishing proof satisfactory to the Director of Industrial Relations of ability to self-insure and to pay any compensation that may become due to his or her employees, ... "

I am aware of the provisions of the Labor Code Section 3700 which require every employer to be insured against liability for workers' compensation or to undertake self-insurance in accordance with the provisions of that code, and I will comply with such provisions before commencing the performance of the work of this contract. I shall supply the Owner with certificates of insurance evidencing that Workers' Compensation Insurance is in effect and providing that the Owner will receive thirty (30) days' notice of cancellation.

\_\_\_\_\_  
Name of Contractor

\_\_\_\_\_  
Signature

\_\_\_\_\_  
Print Name

\_\_\_\_\_  
Date

(In accordance with Article 5 (commencing at Section 1860), Chapter 1, Part 7, Division 2 of the Labor Code, the above certificate must be signed and filed with the awarding body prior to performing any work under the contract.)



**PREVAILING WAGE AND  
RELATED LABOR REQUIREMENTS CERTIFICATION  
DOCUMENT 00 40 06**

PROJECT/CONTRACT NO. \_\_\_\_\_ between Oakland Unified  
School District (“District”) and \_\_\_\_\_  
 (“Contractor” or “Bidder”) (“Contract” or “Project”).

I hereby certify that I will conform to the State of California public works contract requirements regarding prevailing wages, benefits, on-site audits with 48-hours’ notice, payroll records, and apprentice and trainee employment requirements, for all Work on the above Project including, without limitation, labor compliance monitoring and enforcement by the Department of Industrial Relations.

I hereby certify that I will also conform to the Federal Labor Standards Provisions regarding minimum wages, withholding, payrolls and basic records, apprentice and trainee employment requirements, equal employment opportunity requirements, Copeland Act requirements, Davis-Bacon and Related Act requirements, Contract Work Hours and Safety Standards Act requirements, and any and all other applicable requirements for federal funding for all Work on the above Project.

Date: \_\_\_\_\_  
Proper Name of Contractor: \_\_\_\_\_  
Signature: \_\_\_\_\_  
Print Name: \_\_\_\_\_  
Title: \_\_\_\_\_

END OF DOCUMENT

**PRIME BIDDER CERTIFICATION OF DISABLED VETERAN  
BUSINESS ENTERPRISE PARTICIPATION**

**DOCUMENT 00 41 00**

To be completed by the Prime Bidder

PAGE 1 OF 2

<b>PART I – IDENTIFICATION INFORMATION</b>		
BIDDER'S NAME	BUSINESS ADDRESS	TELEPHONE NUMBER
SCHOOL DISTRICT	COUNTY	APPLICATION NO.

**PART II – METHOD OF COMPLIANCE WITH DVBE PARTICIPATION GOALS** – Include this form and any other applicable documents listed in this table with your bid/proposal. Read the three columns in the table below as sentences from left to right. Check the appropriate box to indicate your method of committing the contract dollar amount.

**NOTE:** Architectural, engineering, environmental, land surveying or construction management firms must indicate their method of compliance by marking the appropriate box A, B, C, or D after selection by the District and before the contract is signed.

<b>YOUR BUSINESS ENTERPRISE</b>	<b>AND YOU</b>	<b>AND YOU</b>
<b>A.</b> <input type="checkbox"/> is Disabled Veteran owned and your forces, will perform at least 3 percent of this contract	will include a copy of your DVBE letter from the Office of Small Business and Disabled Veteran Business Enterprise Services (OSDS).	
<b>B.</b> <input type="checkbox"/> is Disabled Veteran owned <b>but is unable</b> to perform the 3 percent of this contract with your forces	will use DVBE subcontractors/ suppliers to bring the contract participation to at least 3 percent	will include a copy of each DVBE's letter from OSDS (including yours, if applicable).
<b>C.</b> <input type="checkbox"/> is <b>not</b> Disabled Veteran owned	will use DVBE subcontractors/ suppliers for at least 3 percent of this contract	
<b>D.</b> <input type="checkbox"/> is unable to meet the required participation goals	will complete a Good Faith Effort to obtain DVBE participation	will include the Prime Bidder's Good Faith Effort Worksheet.

**Note:** An Office of Small Business and Disabled Veteran Business Enterprise Services (OSDS) letter must be attached for each DVBE participating in the contract. The DVBE letter is obtained by application through the OSDS and must be provided at the time of bid opening. If the letter is not provided, the bid may be deemed nonresponsive and may be ineligible for award of the contract.

Continued on reverse side

**PART III – DVBE DOLLAR PARTICIPATION OF BID/PROPOSAL** – *Architectural, engineering, environmental, land surveying or construction management firms complete this part **after** selection by the district and before the contract is signed.*

Show deductive alternate(s) in parenthesis. For more alternates/base bids, use a separate page to show items.

- A. If your business enterprise is a DVBE, list in the appropriate column the total dollar amount of your bid to be performed by your own participation.
- B. List all your DVBE subcontractors/suppliers. Enter in the appropriate column the dollar amount for each of your subcontractors/suppliers.
- C. Enter the total of Lines A and B for each column.
- D. Enter the dollar amount of the bid/proposal to be performed by **non-DVBE** firms. Note: This line is the sum of the prime and subcontractor(s) **non-DVBE** dollar participation.
- E. Enter the sum of the column totals from Line C and Line D. Note: Please be aware that the final determination of DVBE compliance is made based on the contract amount resulting from the district’s acceptance or rejection of alternates.

	<b>BASE BID/PROPOSAL</b>	<b>ALTERNATE #1</b>	<b>ALTERNATE #2</b>	<b>ALTERNATE #3 OR BASE BID B</b>	<b>ALTERNATE #4 OR BASE BID C</b>	<b>ALTERNATE #5 (Modernization or Reconstruction Only)</b>
A. Prime Bidder, if DVBE (own participation)	\$	\$	\$	\$	\$	\$
B. DVBE Subcontractor or Supplier						
1.						
2.						
3.						
4.						
C. Subtotal (A & B)						
D. Non-DVBE						
E. Total Bid						

OAKLAND UNIFIED SCHOOL DISTRICT  
VARIOUS SITES  
DOOR ENTRY SYSTEMS GROUP 5 & 6  
PROJECT NO.:23126 & 23127  
{SR798826}

DVBE PARTICIPATION CERTIFICATE  
DOCUMENT 00 41 00

**PRIME BIDDER GOOD FAITH EFFORT WORKSHEET**  
**DOCUMENT 00 41 01**

*This worksheet is to be used to assist the Prime Bidder in meeting the 3% DVBE participation goal*

PAGE 1 OF 2

BIDDER'S NAME	BUSINESS ADDRESS	CONTACT PERSON
TELEPHONE NUMBER	OWNER	COUNTY

**GENERAL INSTRUCTIONS:**

This worksheet is to be used to assist you in meeting the 3 percent DVBE participation goal. If specific information is not provided for Parts I through III, you do not meet the test of the "Good Faith Effort" and cannot so certify. If you are qualifying based on a "Good Faith Effort" you must include this form with your bid/proposal to the Owner.

**PART I – CONTACTS**

To identify DVBE subcontractors/suppliers for participation in your bid/proposal, contact must be made with each of the following categories. It is recommended that you contact several DVBE organizations.

CATEGORY	TELEPHONE NUMBER	DATE CONTACTED	PERSON CONTACTED
1. Owner			
2. Office of Small Business and Disabled Veteran Business Enterprise Services (OSDS). OSDS provides assistance locating DVBE's at <a href="https://caleprocure.ca.gov/pages/PublicSearch/suppliersearch.aspx">https://caleprocure.ca.gov/pages/PublicSearch/suppliersearch.aspx</a>	(916) 375-4940		
3. DVBE Organizations ( <i>List</i> ):			
4. Write "recorded message" in this column, if applicable.			

**PART II – ADVERTISEMENTS** You must make at least two (2) advertisements, one (1) in a paper that focuses on DVBE and one (1) in a trade paper. Advertisements should be published at least 14 days prior to bid/proposal opening; if you cannot advertise 14 days prior, advertise as soon as possible and provide an explanation. (Advertisements must be published in time to allow for a reasonable response). Advertisements must include that your firm is seeking DVBE participation, the project name and location, your firm’s name, your firm’s contact person, and phone number.

*Attach copies of advertisements to this form.*

FOCUS/TRADE PAPER NAME	CHECK ONE		DATE OF ADVERTISEMENT
	TRADE	FOCUS	

**PART III – DVBE SOLICITATIONS** List DVBE subcontractors/suppliers that were invited to bid. Use the following instructions to complete the remainder of this section (read the three columns as a sentence from left to right). If you need additional space to list DVBE solicitations, please use a separate page and attach to this form.

IF THE DVBE.....	THEN.....	AND.....
Was selected to participate	Check "yes" in the "SELECTED" column, include the applicable dollar amount in Part III of the Prime Bidder Certification	Include a copy of their DVBE letter from OSDs.
Was <b>not</b> selected to participate	Check "no" in the "SELECTED" column	State why in the "REASON NOT SELECTED" column.
Did not respond to your solicitation	Check the "NO RESPONSE" column	

DISABLED VETERANS BUSINESS ENTERPRISES CONTACTED	SELECTED		REASON NOT SELECTED <i>This section must be completed</i>	NO RESPONSE
	YES	NO		

**IMPORTANT NOTE:**

Please be aware that certification of the "Good Faith Effort" may only be made if you fully complete Parts I, II, and III on both sides of this form. A copy of this form must be retained by you and may be subject to a future audit.

**CERTIFICATION**

I, \_\_\_\_\_ certify that I am the bidder's Chief Executive Officer and that I have made a diligent effort to ascertain the facts with regard to the representations made herein. In making this certification, I am aware of Section 12650 et seq. of the Government Code providing for the imposition of treble damages for making false claims.

SIGNATURE OF CHIEF EXECUTIVE OFFICER	DATE
--------------------------------------	------

**DRUG-FREE WORKPLACE CERTIFICATION**  
**DOCUMENT 00 42 00**

The Drug-Free Workplace Act of 1990 (Government Code sections 8350 *et seq.*) requires that every person or organization awarded a contract or grant for the procurement of any property or services from any State agency must certify that it will provide a drug-free workplace by doing certain specified acts. In addition, the Act provides that each contract awarded by a State agency may be subject to suspension of payments or termination of the contract, or both, and the contractor may be subject to debarment from future contracting if the state agency determines that specified acts have occurred.

Pursuant to Government Code Section 8355, every person or organization awarded a contract or grant from a State agency shall certify that it will provide a drug-free workplace by doing all of the following:

- (a) Publishing a statement notifying employees that the unlawful manufacture, distribution, dispensation, possession or use of a controlled substance is prohibited in the person's or organization's workplace and specifying actions which will be taken against employees for violations of the prohibition;
- (b) Establishing a drug-free awareness program to inform employees about all of the following:
  - (1) The dangers of drug abuse in the workplace;
  - (2) The person's or organization's policy of maintaining a drug-free workplace;
  - (3) The availability of drug counseling, rehabilitation and employee-assistance programs;
  - (4) The penalties that may be imposed upon employees for drug abuse Violations;
- (c) Requiring that each employee engaged in the performance of the contract or grant be given a copy of the statement required by subdivision (a) and that, as a condition of employment on the contract or grant, the employee agrees to abide by the terms of the statement.

I, the undersigned, agree to fulfill the terms and requirements of Government Code Section 8355 listed above and will publish a statement notifying employees concerning (a) the prohibition of controlled substance at the workplace, (b) establishing a drug-free awareness program, and (c) requiring that each employee engaged in the performance of the contract or grant be given a copy of the statement required by Section 8355(a) and requiring that the employee agree to abide by the terms of that statement.

I also understand that if the Owner determines that I have either (a) made a false certification herein, or (b) violated this certification by failing to carry out the requirements of Section 8355, that the contract or grant awarded herein is subject to suspension of payments, termination, or both. I further understand that should I violate the terms of the Drug-Free Workplace Act of 1990, I may be subject to debarment in accordance with the requirements of Section 8350 *et seq.*

I acknowledge that I am aware of the provisions of Government Code Section 8350 *et seq.* and hereby certify that I will adhere to the requirements of the Drug-Free Workplace Act of 1990.

\_\_\_\_\_  
Name of Contractor

\_\_\_\_\_  
Signature

\_\_\_\_\_  
Print Name

\_\_\_\_\_  
Date

**TOBACCO-FREE ENVIRONMENT CERTIFICATION**  
**DOCUMENT 00 42 01**

PROJECT NO. \_\_\_\_\_ (“Project”) between Oakland Unified School District (the “District” or the “Owner”) and \_\_\_\_\_ (the “Contractor” or the “Bidder”).

This Tobacco-Free Environment Certification form is required from the successful Bidder.

Pursuant to, without limitation, 20 U.S.C. section 6083, Labor Code sections 6400 et seq., Health & Safety Code sections 104350 et seq., and District Board Policies, all District sites, including the Project site, are tobacco-free environments. Smoking and the use of tobacco products by all persons is prohibited on or in District property. District property includes school buildings, school grounds, school owned vehicles and vehicles owned by others while on District property.

I acknowledge that I am aware of the District’s policy regarding tobacco-free environments at District sites, including the Project site, and I hereby certify that I will adhere to the requirements of that policy and not permit any of my firm’s employees, agents, subcontractors, or my firm’s subcontractors’ employees or agents to use tobacco and/or smoke on the Project site.

Date: \_\_\_\_\_

Proper Name of Contractor: \_\_\_\_\_

Signature: \_\_\_\_\_

Print Name: \_\_\_\_\_

Title: \_\_\_\_\_



**ASBESTOS & OTHER HAZARDOUS MATERIALS CERTIFICATION**  
**DOCUMENT 00 42 02**

Contractor hereby certifies that no Asbestos, or Asbestos-Containing Materials, polychlorinated biphenyl (PCB), or any material listed by the federal or state Environmental Protection Agency or federal or state health agencies as a hazardous material, or any other material defined as being hazardous under federal or state laws, rules, or regulations "New Material Hazardous", shall be furnished, installed, or incorporated in any way into the Project or in any tools, devices, clothing, or equipment used to affect any portion of Contractor's work on the Project for District.

Contractor further certifies that it has instructed its employees with respect to the above-mentioned standards, hazards, risks, and liabilities.

Asbestos and/or asbestos-containing material shall be defined as all items containing but not limited to chrysotile, crocidolite, amosite, anthophyllite, tremolite, and actinolite. Any or all material containing greater than one-tenth of one percent (.1%) asbestos shall be defined as asbestos-containing material.

Any disputes involving the question of whether or not material is New Hazardous Material shall be settled by electron microscopy or other appropriate and recognized testing procedure, at the District's determination. The costs of any such tests shall be paid by Contractor if the material is found to be New Hazardous Material.

All Work or materials found to be New Hazardous Material or Work or material installed with "New Hazardous Material" containing equipment will be immediately rejected and this Work will be removed at Contractor's expense at no additional cost to the District.

Contractor has read and understood the document Hazardous Materials Procedures & Requirements, and shall comply with all the provisions outlined therein.

Date: \_\_\_\_\_

Proper Name of Contractor: \_\_\_\_\_

Signature: \_\_\_\_\_

Print Name: \_\_\_\_\_

Title: \_\_\_\_\_

**LEAD-BASED MATERIALS CERTIFICATION**  
**DOCUMENT 00 42 03**

PROJECT/CONTRACT NO. \_\_\_\_\_ between Oakland Unified School District ("District") and \_\_\_\_\_ ("Contractor" or "Bidder") ("Contract" or "Project").

This certification provides notice to the Contractor that:

- 1) Contractor's work may disturb lead-containing building materials.
- 2) Contractor shall notify the District if any work may result in the disturbance of lead-containing building materials.
- 3) Contractor shall comply with the Renovation, Repair and Painting Rule, if lead-based paint is disturbed in a six-square-foot or greater area indoors or a 20-square-foot or greater area outdoors.

**1. Lead as a Health Hazard**

Lead poisoning is recognized as a serious environmental health hazard facing children today. Even at low levels of exposure, much lower than previously believed, lead can impair the development of a child's central nervous system, causing learning disabilities, and leading to serious behavioral problems. Lead enters the environment as tiny lead particles and lead dust disburse when paint chips, chalks, peels, wears away over time, or is otherwise disturbed. Ingestion of lead dust is the most common pathway of childhood poisoning; lead dust gets on a child's hands and toys and then into a child's mouth through common hand-to-mouth activity. Exposures may result from construction or remodeling activities that disturb lead paint, from ordinary wear and tear of windows and doors, or from friction on other surfaces.

Ordinary construction and renovation or repainting activities carried out without lead-safe work practices can disturb lead-based paint and create significant hazards. Improper removal practices, such as dry scraping, sanding, or water blasting painted surfaces, are likely to generate high volumes of lead dust.

Because the Contractor and its employees will be providing services for the District, and because the Contractor's work may disturb lead-containing building materials, CONTRACTOR IS HEREBY NOTIFIED of the potential presence of lead-containing materials located within certain buildings utilized by the District. All school buildings built prior to 1978 are presumed to contain some lead-based paint until sampling proves otherwise.

**2. Overview of California Law**

Education Code section 32240 et seq. is known as the Lead-Safe Schools Protection Act. Under this act, the Department of Health Services is to conduct a sample survey of schools in the State of California for the purpose of developing risk factors to predict lead contamination in public schools. (Ed. Code, § 32241.)

Any school that undertakes any action to abate existing risk factors for lead is required to utilize trained and state-certified contractors, inspectors, and workers. (Ed. Code, § 32243, subd. (b).) Moreover, lead-based paint, lead plumbing, and solders, or other potential sources of lead contamination, shall not be utilized in the construction of any new school facility or the modernization or renovation of any existing school facility. (Ed. Code, § 32244.)

Both the Federal Occupational Safety and Health Administration ("Fed/OSHA") and the California Division of Occupational Safety and Health ("Cal/OSHA") have implemented safety orders applicable to all construction work where a contractor's employee may be occupationally exposed to lead.

The OSHA Regulations apply to all construction work where a contractor's employee may be occupationally exposed to lead. The OSHA Regulations contain specific and detailed requirements imposed on contractors subject to those regulations. The OSHA Regulations define construction work as work for construction, alteration, and/or repair, including painting and decorating. Regulated work includes, but is not limited to, the following:

- a. Demolition or salvage of structures where lead or materials containing lead are present;
- b. Removal or encapsulation of materials containing lead;
- c. New construction, alteration, repair, or renovation of structures, substrates, or portions thereof, that contain lead, or materials containing lead;
- d. Installation of products containing lead;
- f. Lead contamination/emergency cleanup;
- g. Transportation, disposal, storage, or containment of lead or materials containing lead on the site or location at which construction activities are performed; and
- h. Maintenance operations associated with the construction activities described in the subsection.

Because it is assumed by the District that all painted surfaces (interior as well as exterior) within the District contain some level of lead, it is imperative that the Contractor, its workers and subcontractors fully and adequately comply with all applicable laws, rules and regulations governing lead-based materials (including title 8, California Code of Regulations, section 1532.1).

**Contractor shall notify the District if any Work may result in the disturbance of lead-containing building materials. Any and all Work that may result in the disturbance of lead-containing building materials shall be coordinated through the District. A signed copy of this Certification shall be on file prior to beginning Work on the Project, along with all current insurance certificates.**

**3. Renovation, Repair and Painting Rule, Section 402(c)(3) of the Toxic Substances Control Act**

The EPA requires lead safe work practices to reduce exposure to lead hazards created by renovation, repair and painting activities that disturb lead-based paint. Pursuant to the Renovation, Repair and Painting Rule (RRP), renovations in homes, childcare facilities, and schools built prior to 1978 must be conducted by certified renovations firms, using renovators with training by a EPA-accredited training provider, and fully and adequately complying with all applicable laws, rules and regulations governing lead-based materials, including those rules and regulations appearing within title 40 of the Code of Federal Regulations as part 745 (40 CFR 745).

The RRP requirements apply to all contractors who disturb lead-based paint in a six-square-foot or greater area indoors or a 20-square-foot or greater area outdoors. If a DPH-certified inspector or risk assessor determines that a home constructed before 1978 is lead-free, the federal certification is not required for anyone working on that particular building.

**4. Contractor's Liability**

If the Contractor fails to comply with any applicable laws, rules, or regulations, and that failure results in a site or worker contamination, the Contractor will be held solely responsible for all costs involved in any required corrective actions, and shall defend, indemnify, and hold harmless the District, pursuant to the indemnification provisions of the Contract, for all damages and other claims arising therefrom.

If lead disturbance is anticipated in the Work, only persons with appropriate accreditation, registrations, licenses, and training shall conduct this Work.

It shall be the responsibility of the Contractor to properly dispose of any and all waste products, including, but not limited to, paint chips, any collected residue, or any other visual material that may occur from the prepping of any painted surface. It will be the responsibility of the Contractor to provide the proper disposal of any hazardous waste by a certified hazardous waste hauler. This company shall be registered with the Department of Transportation (DOT) and shall be able to issue a current manifest number upon transporting any hazardous material from any school site within the District.

The Contractor shall provide the District with any sample results prior to beginning Work, during the Work, and after the completion of the Work. The District may request to examine, prior to the commencement of the Work, the lead training records of each employee of the Contractor.

THE CONTRACTOR HEREBY ACKNOWLEDGES, UNDER PENALTY OF PERJURY, THAT IT:

1. HAS RECEIVED NOTIFICATION OF POTENTIAL LEAD-BASED MATERIALS ON THE OWNER'S PROPERTY;
2. IS KNOWLEDGEABLE REGARDING AND WILL COMPLY WITH ALL APPLICABLE LAWS, RULES, AND REGULATIONS GOVERNING WORK WITH, AND DISPOSAL, OF LEAD.

THE UNDERSIGNED WARRANTS THAT HE/SHE HAS THE AUTHORITY TO SIGN ON BEHALF OF AND BIND THE CONTRACTOR. THE DISTRICT MAY REQUIRE PROOF OF SUCH AUTHORITY.

Date: \_\_\_\_\_

Proper Name of Contractor: \_\_\_\_\_

Signature: \_\_\_\_\_

Print Name: \_\_\_\_\_

Title: \_\_\_\_\_

END OF DOCUMENT

**IMPORTED MATERIALS CERTIFICATION**  
**DOCUMENT 00 42 04**

PROJECT NO. \_\_\_\_\_ (“Project”) between Oakland Unified School District (the “District” or the “Owner”) and \_\_\_\_\_ (the “Contractor” or the “Bidder”).

This form shall be executed by Contractor and by all entities that, in any way, provide or deliver and/or supply any soils, aggregate, or related materials (“Fill”) to the Project Site(s). All Fill shall satisfy the requirements of any environmental review of the Project performed pursuant to the statutes and guidelines of the California Environmental Quality Act, sections 21000 et seq. of the Public Resources Code (“CEQA”), and the requirements of sections 17210 et seq. of the Education Code, including requirements for a Phase I environmental assessment acceptable to the State of California Department of Education and Department of Toxic Substances Control.

To the furthest extent permitted by California law, the indemnification provisions in the Contract Documents apply to, without limitation, any claim(s) connected with providing, delivering, and/or supplying Fill.

Certification of:     Delivery Firm/Transporter                       Supplier                       Manufacturer  
                                  Wholesaler     Broker     Retailer  
                                  Distributor     Other \_\_\_\_\_

---

Type of Entity:     Corporation     General Partnership  
                                  Limited Partnership     Limited Liability Company  
                                  Sole Proprietorship     Other \_\_\_\_\_

Name of firm ("Firm"): \_\_\_\_\_

Mailing address: \_\_\_\_\_

Addresses of branch office used for this Project: \_\_\_\_\_

If subsidiary, name and address of parent company: \_\_\_\_\_

By my signature below, I hereby certify that I am aware of section 25260 of the Health and Safety Code and the sections referenced therein regarding the definition of hazardous material. I further certify on behalf of the Firm that all soils, aggregates, or related materials provided, delivered, and/or supplied or that will be provided, delivered, and/or supplied by this Firm to the Project Site(s) are free of any and all hazardous material as defined in section 25260 of the Health and Safety Code. I further certify that I am authorized to make this certification on behalf of the Firm.

Date: \_\_\_\_\_

Proper Name of Contractor: \_\_\_\_\_

Signature: \_\_\_\_\_

Print Name: \_\_\_\_\_

Title: \_\_\_\_\_

**FINGERPRINTING NOTICE AND ACKNOWLEDGMENT  
FOR CONSTRUCTION CONTRACTS**

(Education Code Section 45125.2)

**DOCUMENT 00 43 00**

Business entities entering into contracts with the Owner for the construction, reconstruction, rehabilitation or repair of a facility may comply with Education Code section 45125.2, in which case it would not have to comply with Section 45125.1. If such an entity is not compliant with Section 45125.2, then it must comply with Section 45125.1. Such entities are responsible for ensuring full compliance with the law and should therefore review all applicable statutes and regulations. Therefore, the following information is provided simply to assist you with compliance with the law:

1. The Owner has determined that your employee(s), or you as a sole proprietor, will have more than limited contact with students, therefore the law requires that you must use one or more of the following methods to ensure the safety of pupils (Education Code §45125.2(a)):
  - a. Install a physical barrier at the worksite to limit contact with pupils.
  - b. If you are not a sole proprietorship, have one of your employees, whom the Department of Justice has ascertained has not been convicted of a violent or serious felony (see *Attachment A* to this Notice and Acknowledgement), continually monitor and supervise all of your employees. For the Department of Justice to so ascertain, your employee may submit fingerprints to the Department of Justice pursuant to Education Code section 45125.1(a).
  - c. Arrange, with Owner's approval, for surveillance of your employees by Owner's personnel.

Prior to commencing the Work, you shall submit the Independent Contractor Student Contact Form (see *Attachment B* to this Notice and Acknowledgement) to the Owner, which will indicate which of the above methods you will use.

2. If you are providing services in an emergency or exceptional situation, you are not required to comply with Education Code section 45125.2, above. An "emergency or exceptional" situation is one in which pupil health or safety is endangered or when repairs are needed to make a facility safe and habitable. Owner shall determine whether an emergency or exceptional situation exists. (Education Code §45125.2(d).)

{SR798850} 1

3. If you use one or more of the three methods in Section 1 (above), you are not required to comply with Education Code section 45125.1. (Education Code §45125.2(b).)

I have read the foregoing and agree to comply with the requirements of this notice and Education Code sections 45125.1 and 45125.2 as applicable.

Dated: \_\_\_\_\_

\_\_\_\_\_  
Signature

Name: \_\_\_\_\_

Title: \_\_\_\_\_



## ATTACHMENT A

### Violent and Serious Felonies

Under Education Code section 45125.2, no employee of a contractor or subcontractor who has been convicted of or has criminal proceedings pending for a violent or serious felony may come into contact with any student. A violent felony is any felony listed in subdivision (c) of Section 667.5 of the Penal Code. Those felonies are presently defined as:

- (1) Murder or voluntary manslaughter.
- (2) Mayhem.
- (3) Rape as defined in paragraph (2) or (6) of subdivision (a) of Section 261 or paragraph (1) or (4) of subdivision (a) of Section 262.
- (4) Sodomy as defined in subdivision (c) or (d) of Section 286.
- (5) Oral copulation as defined in subdivision (c) or (d) of Section 288a.
- (6) Lewd or lascivious act as defined in subdivision (a) or (b) of Section 288.
- (7) Any felony punishable by death or imprisonment in the state prison for life.
- (8) Any felony in which the defendant inflicts great bodily injury on any person other than an accomplice which has been charged and proved as provided for in Section 12022.7, 12022.8, or 12022.9 on or after July 1, 1977, or as specified prior to July 1, 1977, in Sections 213, 264, and 461, or any felony in which the defendant uses a firearm which use has been charged and proved as provided in subdivision (a) of Section 12022.3, or Section 12022.5 or 12022.55.
- (9) Any robbery.
- (10) Arson, in violation of subdivision (a) or (b) of Section 451.
- (11) Sexual penetration as defined in subdivision (a) or (j) of Section 289.
- (12) Attempted murder.
- (13) A violation of Section 18745, 18750, or 18755.
- (14) Kidnapping.

{SR798850}3

- (15) Assault with the intent to commit a specified felony, in violation of Section 220.
- (16) Continuous sexual abuse of a child, in violation of Section 288.5.
- (17) Carjacking, as defined in subdivision (a) of Section 215.
- (18) Rape, spousal rape, or sexual penetration, in concert, in violation of Section 264.1.
- (19) Extortion, as defined in Section 518, which would constitute a felony violation of Section 186.22 of the Penal Code.
- (20) Threats to victims or witnesses, as defined in Section 136.1, which would constitute a felony violation of Section 186.22 of the Penal Code.
- (21) Any burglary of the first degree, as defined in subdivision (a) of Section 460, wherein it is charged and proved that another person, other than an accomplice, was present in the residence during the commission of the burglary.
- (22) Any violation of Section 12022.53.
- (23) A violation of subdivision (b) or (c) of Section 11418.

A serious felony is any felony listed in subdivision (c) Section 1192.7 of the Penal Code. Those felonies are presently defined as:

- (1) Murder or voluntary manslaughter; (2) Mayhem; (3) Rape; (4) Sodomy by force, violence, duress, menace, threat of great bodily injury, or fear of immediate and unlawful bodily injury on the victim or another person; (5) Oral copulation by force, violence, duress, menace, threat of great bodily injury, or fear of immediate and unlawful bodily injury on the victim or another person; (6) Lewd or lascivious act on a child under the age of 14 years; (7) Any felony punishable by death or imprisonment in the state prison for life; (8) Any felony in which the defendant personally inflicts great bodily injury on any person, other than an accomplice, or any felony in which the defendant personally uses a firearm; (9) Attempted murder; (10) Assault with intent to commit rape, or robbery; (11) Assault with a deadly weapon or instrument on a peace officer; (12) Assault by a life prisoner on a non-inmate; (13) Assault with a deadly weapon by an inmate; (14) Arson; (15) Exploding a destructive device or any explosive with intent to injure; (16) Exploding a destructive device or any explosive causing bodily injury, great bodily injury, or mayhem; (17) Exploding a destructive device or any explosive with intent to murder; (18) Any burglary of the first degree; (19)

{SR798850}4

Robbery or bank robbery; (20) Kidnapping; (21) Holding of a hostage by a person confined in a state prison; (22) Attempt to commit a felony punishable by death or imprisonment in the state prison for life; (23) Any felony in which the defendant personally used a dangerous or deadly weapon; (24) Selling, furnishing, administering, giving, or offering to sell, furnish, administer, or give to a minor any heroin, cocaine, phencyclidine (PCP), or any methamphetamine-related drug, as described in paragraph (2) of subdivision (d) of Section 11055 of the Health and Safety Code, or any of the precursors of methamphetamines, as described in subparagraph (A) of paragraph (1) of subdivision (f) of Section 11055 or subdivision (a) of Section 11100 of the Health and Safety Code; (25) Any violation of subdivision (a) of Section 289 where the act is accomplished against the victim's will by force, violence, duress, menace, or fear of immediate and unlawful bodily injury on the victim or another person; (26) Grand theft involving a firearm; (27) carjacking; (28) any felony offense, which would also constitute a felony violation of Section 186.22; (29) assault with the intent to commit mayhem, rape, sodomy, or oral copulation, in violation of Section 220; (30) throwing acid or flammable substances, in violation of Section 244; (31) assault with a deadly weapon, firearm, machine gun, assault weapon, or semiautomatic firearm or assault on a peace officer or firefighter, in violation of Section 245; (32) assault with a deadly weapon against a public transit employee, custodial officer, or school employee, in violation of Sections 245.2, 245.3, or 245.5; (33) discharge of a firearm at an inhabited dwelling, vehicle, or aircraft, in violation of Section 246; (34) commission of rape or sexual penetration in concert with another person, in violation of Section 264.1; (35) continuous sexual abuse of a child, in violation of Section 288.5; (36) shooting from a vehicle, in violation of subdivision (c) or (d) of Section 26100; (37) intimidation of victims or witnesses, in violation of Section 136.1; (38) criminal threats, in violation of Section 422; (39) any attempt to commit a crime listed in this subdivision other than an assault; (40) any violation of Section 12022.53; (41) a violation of subdivision (b) or (c) of Section 11418; and (42) any conspiracy to commit an offense described in this subdivision.

**ATTACHMENT B**

**INDEPENDENT CONTRACTOR STUDENT CONTACT FORM  
FOR CONSTRUCTION CONTRACTS**

Note: This form must be submitted by Contractor before it may commence any work.

Contractor Firm Name: \_\_\_\_\_ Data Media Systems, Inc \_\_\_\_\_  
Supervisor/Foreman Name: \_\_\_\_\_  
Start Date: \_\_\_\_\_ 01-25-2024 \_\_\_\_\_  
Completion Date: \_\_\_\_\_ 4-23-2024 \_\_\_\_\_  
Location of Work: \_\_\_\_\_  
Hours of Work: \_\_\_\_\_  
Length of Time on Grounds: \_\_\_\_\_  
Number of Employees on the Job: \_\_\_\_\_

I am an owner or officer of Contractor authorized to sign this document on behalf of Contractor. Contractor acknowledges that the Owner has determined that Contractor's employees, or that Contractor as a sole proprietor, will have more than limited contact with students. Therefore, in order to comply with Education Code section 45125.2, Contractor will use the following methods to ensure student safety (check at least one):

- [ X] A physical barrier will be installed at the worksite to limit contact with pupils.
- [ ] Contractor is not a sole proprietorship, and its employees will be continually monitored and supervised by one of its employees who has not been convicted of a violent or serious felony.

Name of Supervising Employee:

\_\_\_\_\_

Date of Department of Justice verification that supervising employee has not been convicted of a violent or serious felony:

\_\_\_\_\_

Name of employee who is the custodian of the Department of Justice verification information:

\_\_\_\_\_

- [ ] The Owner has agreed that Contractor's employees, or Contractor as sole proprietor, will be surveilled by Owner's personnel.

If Contractor does not comply with the requirements of Education Code section 45125.2, then Contractor will comply with the requirements of Education Code section 45125.1.

I declare under penalty of perjury that the foregoing is true and correct to the best of my knowledge.

Dated: 12/21/2023

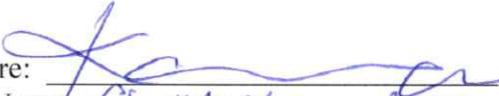
Signature:   
Typed Name: Christopher Kooger  
Title: owner  
Contractor: DATA MEDIA SERVICES INC.

**ROOF PROJECT CERTIFICATION**  
**DOCUMENT 00 43 02**

(Public Contract Code §3006(a) and (b))

Owner: Oakland Unified School District

Contract: \_\_\_\_\_ Contract

\_\_\_\_\_, Alameda County, California

I, \_\_\_\_\_ [name], \_\_\_\_\_ [name of employer], certify that I have not offered, given, or agreed to give, received, accepted, or agreed to accept, any gift, contribution, or any financial incentive whatsoever to or from any person in connection with the roof project contract. As used in this certification, "person" means any natural person, business, partnership, corporation, union, committee, club, or other organization, entity, or group of individuals. Furthermore, I, \_\_\_\_\_ [name], \_\_\_\_\_ [name of employer], certify that I do not have, and throughout the duration of the contract, I will not have, any financial relationship in connection with the performance of this contract with any architect, engineer, roofing, consultant, materials manufacturer, distributor, or vendor that is not disclosed below.

I, \_\_\_\_\_ [name], \_\_\_\_\_ [name of employer], have the following financial relationships, with an architect, engineer, roofing consultant, materials manufacturer, distributor, or vendor, or other person in connection with the following roof project contract:

\_\_\_\_\_  
[name and address of building, contract date and number]

\_\_\_\_\_  
[name and address of building, contract date and number]

\_\_\_\_\_  
[name and address of building, contract date and number]

\_\_\_\_\_  
[name and address of building, contract date and number]

I certify that to the best of my knowledge, the contents of this disclosure are true, or are believed to be true.

\_\_\_\_\_ Signature

\_\_\_\_\_ Date

\_\_\_\_\_ Print Name

\_\_\_\_\_ Print Name of Employer

NOTICE OF AWARD  
DOCUMENT 00 50 00

DATE: \_\_\_\_\_

TO: \_\_\_\_\_

ADDRESS: \_\_\_\_\_

CONTRACT: \_\_\_\_\_

Please take notice that the above contract has been awarded by the Oakland Unified School District (“Owner”) to you, in the amount of \_\_\_\_\_ Dollars (\$ \_\_\_\_\_).

1. You must deliver the following documents to the Owner by the tenth (10th) day following the date of receipt of this Notice of Award and prior to the commencement of the Work, or prior to the commencement of the Work, whichever is earlier:
  - a. Two fully executed counterparts of the Agreement (see attached form). Each copy of the Agreement must bear your original signature on the signature page.
  - b. One original set of the additional insured and other required endorsements, and the insurance declaration pages.
  - c. An executed Drug-Free Workplace Certification.
  - d. An executed Student Contact Form (see Exhibit B to the Fingerprinting Notice and Acknowledgement Form).
  - e. An executed Roof Project Certification (if required for the contract).
  - f. Any other documents required by the Instructions to Bidders to be submitted by the tenth (10th) day following this Notice of Award and prior to the commencement of the Work.
2. You must deliver the certified baseline schedule (see General Conditions §3.9.1) to the Owner within two weeks of award of the Contract and prior to the commencement of the Work.
3. Any failure to deliver these documents within the time specified would allow the Owner to deem your bid to have been abandoned, to annul this Notice of Award, and to declare your bid security to have been forfeited.
4. Before you may start any Work, you must attend a preconstruction conference. The preconstruction conference may be arranged through Owner’s representative,

**OAKLAND UNIFIED SCHOOL DISTRICT**  
VARIOUS SITES  
DOOR ENTRY SYSTEMS GROUP 5 & 6  
PROJECT NO 23126 & 23127

**NOTICE OF AWARD**  
**DOCUMENT 00 50 00-1**

\_\_\_\_\_ at \_\_\_\_\_@\_\_\_\_\_. Questions regarding bonds and insurance may be directed to \_\_\_\_\_ at \_\_\_\_\_@\_\_\_\_\_. All other inquiries regarding the Project should be directed to \_\_\_\_\_ at \_\_\_\_\_@\_\_\_\_\_.

5. Upon commencement of the Work, you and each of your Subcontractors shall certify, maintain, and furnish payroll records as required by the Division of Labor Standards Enforcement, in accordance with California Labor Code Sections 1776 and 1771.4.

**OWNER:**

\_\_\_\_\_  
Name: \_\_\_\_\_  
Title: \_\_\_\_\_



**GUARANTEE/WARRANTY FORM**  
**DOCUMENT 00 51 00**

\_\_\_\_\_ ("Contractor") hereby represents and warrants that the \_\_\_\_\_ work ("Work") which Contractor has installed for the Oakland Unified School District ("District") on the following project:

PROJECT: Various Sites Door Entry Systems Group 5 & 6 ("Project" or "Contract") has been performed in accordance with the requirements of the Contract Documents and that the Work as installed will fulfill the requirements of the Contract Documents.

The undersigned agrees to repair or replace any or all of such Work that may prove to be defective in workmanship or material together with any other adjacent Work that may be displaced in connection with such replacement within the warranty period provided in the Contract Documents, including but not limited to Articles 3, 9, and 12 of the General Conditions. Contractor believes that the date of completion of the entire Work was \_\_\_\_\_, 20\_\_.

In the event of the undersigned's failure to repair or replace any Work under the warranty, the District reserves all rights under the Contract Documents, including but not limited to those in Articles 3, 9, and 12 of the General Conditions.

Date: \_\_\_\_\_

Proper Name of Contractor: \_\_\_\_\_

Signature: \_\_\_\_\_

Print Name: \_\_\_\_\_

Title: \_\_\_\_\_

Representatives to be contacted for service subject to terms of Contract:

Name: \_\_\_\_\_

Address: \_\_\_\_\_

Phone No.: \_\_\_\_\_

Email: \_\_\_\_\_

END OF DOCUMENT

**NOTICE TO PROCEED**  
**DOCUMENT 00 51 01**

DATE: \_\_\_\_\_, 20\_\_

TO: \_\_\_\_\_, Inc., \_\_\_\_\_, \_\_\_\_\_, CA 9\_\_\_\_\_

CONTRACT: Various Sites Door Entry Systems Group 5 & 6

The Oakland Unified School District (“Owner”) hereby notifies you that the Contract Time (see Article III of the Agreement for the above Contract) will commence to run on \_\_\_\_\_, 20\_\_. On that date, you may commence performance of your obligations with respect to Work under the Contract Documents. However, before you start any Work at the site, you must have submitted all documents required by the Instructions to Bidders, the Notice of Award, and the General Conditions, including a schedule of values.

Please note that all requests or claims for additional money or time must comply with the contract’s requirements, including General Conditions section 4.5, or else you may waive your right to recover additional money or time.

**OWNER:**

\_\_\_\_\_  
Name: \_\_\_\_\_  
Title: \_\_\_\_\_

**SCHEDULE Z**  
**DOCUMENT 00 52 00**

**CERTIFICATION REGARDING DEBARMENT, SUSPENSION, INELIGIBILITY  
AND VOLUNTARY EXCLUSION – LOWER TIER COVERED TRANSACTION**

Under the requirements of OMB Circular A-133 Supplement, part 3, Section 1, the District is required to obtain certifications that contractors and sub-grantees receiving awards exceeding \$25,000 have not been suspended or debarred from participating in federally funded procurement activities.

The undersigned company certifies to the best of its knowledge and belief that neither it nor its principals is presently debarred, suspended, proposed for debarment, declared ineligible or voluntarily excluded from participation in this transaction by any Federal department or agency; and that none of its subcontractors are presently debarred, suspended, proposed for debarment, declared ineligible or voluntarily excluded from participation in this transaction by any Federal department or agency.

If the undersigned company is unable to certify to the above statement, it shall attach an explanation to this proposal.

By signing and submitting this form the company's authorized representative hereby certifies as to the above stated conditions.

_____		_____	
Company Name		Signature of Authorized Representative	
_____		_____	
Address		Type or Print Name	
_____	_____	_____	_____
Area Code	Phone	Date	Type or Print Name

**END OF DOCUMENT**

*[for competitively bid projects over \$60,000]*

**AGREEMENT BETWEEN OWNER AND CONTRACTOR**

This Agreement, effective \_\_\_\_\_, 20\_\_, is by and between the Oakland Unified School District, in Alameda County, California, hereinafter called the “Owner,” and hereinafter called the “Contractor.”

**WITNESSETH:** That the Contractor and the Owner for the consideration hereinafter named agree as follows:

**ARTICLE I. SCOPE OF WORK.**

The Contractor agrees to furnish all labor, equipment and materials, including tools, implements, and appliances required, and to perform all the work required, by the Contract (the “Work”) in a good and workmanlike manner, free from any and all liens and claims from mechanics, material suppliers, subcontractors, artisans, machinists, teamsters, freight carriers, and laborers, and as specified in

the Various Sites Door Entry Systems Group 5 Project No 23126, at various sites. Sites: Oakland Tech Upper Campus, Montera Middle School, Jefferson CDC, Hillcrest Elementary School, & Bella Vista CDC.

all in strict compliance with the plans, drawings and specifications therefore prepared by

Oakland Unified School District, Oakland, CA 94601, PH: 510-535-7044,

and other Contract Documents relating thereto.

The Contract as awarded includes the base scope of work only.

During the Work, the Contractor shall ensure that all Work, including but not limited to Work performed by Subcontractors, is performed in compliance with all applicable legal, contractual, and local government requirements related to COVID-19 and other public health emergencies, including “social distancing,” masks, and hygiene as may be ordered by the State or local authorities and as may be directed in the Contract Documents. In addition, the Contractor and its Subcontractors shall refer to specification section 01 35 13.23 (Site Standards and Covid Vaccination Requirements).

This contract is NOT subject to the District’s Project Labor Agreement. The full version of OUSD’s latest Project Labor Agreement can be found by going to the OUSD home page: [ousd.org](http://ousd.org) > Offices and Departs > Facilities Planning & Management Department > Click Opportunities drop-down > Project Labor Agreement(PLA) is at the

bottom.

## **ARTICLE II. CONTRACT DOCUMENTS.**

The Contractor and the Owner agree that all of the documents listed in Article 1.1.1 of the General Conditions form the “Contract Documents” which form the “Contract.” The Contractor and its subcontractors must use the Owner’s program software COLBI DOCS for projects.

## **ARTICLE III. TIME TO COMPLETE AND LIQUIDATED DAMAGES.**

Time is of the essence in this Contract, and the time of Completion for the Work (“the Contract Time”) shall be ninety (90) calendar days which shall start to run on (a) the date of commencement of the Work as established in the Owner’s Notice to Proceed, or (b) if no date of commencement is established in a Notice to Proceed from Owner, the date of Contractor’s actual commencement of the Work (including mobilization).

The site for the Contract will not be available to the Contractor for construction on the following dates: N/A. The Contractor shall not be entitled to time extensions for lack of access to the site on these dates.

Failure to Complete the Work within the Contract Time and in the manner provided for by the Contract Documents, or failure to complete any specified portion of the Work by a milestone deadline, shall subject the Contractor to liquidated damages. The actual occurrence of damages and the actual amount of the damages which the Owner would suffer if the Work were not Completed within the Contract Time, or if any specified portion of the Work were not completed by a milestone deadline, are dependent upon many circumstances and conditions which could prevail in various combinations and, from the nature of the case, it is impracticable and extremely difficult to fix the actual damages. Damages which the Owner would suffer in the event of such delay include, but are not limited to, loss of the use of the Work, disruption of activities, costs of administration and supervision, third party claims, and the incalculable inconvenience and loss suffered by the public.

Accordingly, the parties agree that \$1,000.00 per calendar day of delay shall be the damages which the Owner shall directly incur upon failure of the Contractor to Complete the Work within the Contract Time or Complete any specified portion of the Work by a milestone deadline, as described above. Liquidated damages will accrue for failure to meet milestone deadlines even if the Contractor Completes the Work within the Contract Time.

In addition, Contractor shall be subject to liquidated damages, or actual damages if liquidated damages are not recoverable under law, for causing another contractor on the Project to fail to timely complete its work under its contract or for causing delayed *completion* of the Project. The actual occurrence of damages and the actual amount of the

{SR799843}2

damages which the Owner would suffer if another contractor on the Project were to fail to timely complete its work under its contract or delay *completion* of the Project are dependent upon many circumstances and conditions which could prevail in various combinations and, from the nature of the case, it is impracticable and extremely difficult to fix the actual damages. Damages which the Owner would suffer in the event of such delay include, but are not limited to, loss of the use of the Work, loss of use of the other contractor's work, loss of use of the Project, disruption of activities, costs of administration and supervision, third party claims, the incalculable inconvenience and loss suffered by the public, and an Owner's inability to recover its delay damages from the contractors whose work was delayed by Contractor.

Accordingly, the parties agree that \$ 1,000.00 for each calendar day of delay shall be the amount of damages which the Owner shall directly incur upon Contractor causing another contractor on the Project to fail to timely complete its work under its contract or causing delayed *completion* of the Project.

For Contractor's obligations regarding claims against Owner from other contractors on the Project alleging that Contractor caused delays to their work, see General Conditions sections 3.7.4, 3.16 and 6.2.3.

If liquidated damages accrue as described above, the Owner, in addition to all other remedies provided by law, shall have the right to assess the liquidated damages at any time, and to withhold liquidated damages (and any interest thereon) at any time from any and all retention or progress payments, which would otherwise be or become due the Contractor. In addition, if it is reasonably apparent to the Owner before liquidated damages begin to accrue that they will accrue, Owner may assess and withhold, from retention or progress payments, the estimated amount of liquidated damages that will accrue in the future. If the retained percentage or withheld progress payments are not sufficient to discharge all liabilities of the Contractor incurred under this Article, the Contractor and its sureties shall continue to remain liable to the Owner until all such liabilities are satisfied in full.

If Owner accepts any work or makes any payment under the Contract Documents after a default by reason of delays, the payment or payments shall in no respect constitute a waiver or modification of any provision in the Contract Documents regarding time of Completion, milestone deadlines, or liquidated damages.

#### **ARTICLE IV. PAYMENT AND RETENTION.**

The Owner agrees to pay the Contractor in current funds \_\_\_\_\_ Dollars (\$ \_\_\_\_\_) for work satisfactorily performed after receipt of properly documented and submitted Applications for Payment and to make payments on account thereof, as provided in the General Conditions. Contract Documents other than special allowances. Any payment from an allowance is

{SR799843}3

entirely at the discretion, and only with the advanced written approval, of the Owner. To request payment from an Allowance, the Contractor must fully comply with the Contract Documents' requirements related to Notice to Potential Changes, Change Order Requests, and Claims, including but not limited to Articles 4 and 7 of the General Conditions and its provisions regarding waiver of rights for failure to comply. If the Owner approves in writing a payment from an Allowance, no change order approved by Owner's governing body shall be required, but Contractor must sign an Allowance expenditure form, after which the Contractor may include a request for such payment in its next progress payment application. Contractor's inclusion of a request for such payment in a progress payment application, or Contractor's acceptance of a progress payment that includes such payment, shall act as a full and complete waiver by Contractor of all rights to recover additional money related to the underlying basis of such payment; and such waiver shall be in addition to any other waiver that applies under the Contract Documents (including Article 4 of the General Conditions). If Contractor requests a time extension or other consideration in connection with or related to a requested payment from an Allowance, Contractor must comply with the Contract Documents' requirements related to Notice to Potential Changes, Change Order Requests, and Claims, including but not limited to Articles 4, 7, and 8 of the General Conditions and their provisions regarding waiver of rights for failure to comply, and no such time extension or other consideration may be issued until a change order is approved by the Owner's governing body pursuant to the Contract Documents. The amount of an Allowance may only be increased by a change order approved by Owner's governing body. Once an Allowance is fully spent, the Contractor must request any additional compensation pursuant to the procedures in the Contract Documents for Notices of Potential Claim, Change Order Requests, and Claims, and payment must be made by a change order approved by the Owner's governing body pursuant to the General Conditions. Upon Completion of the Work, all amounts in an Allowance that remain unspent and unencumbered shall remain the property of the Owner, Contractor shall have no claim to such funds, the Owner shall be entitled to a credit for such unused amounts against the above contract price, and the Owner may withhold such credit from any progress payment or release of retention.

The Owner has made a finding that this Project is substantially complex and requires a retention amount greater than 5%. (Public Contract Code section 7201.) The retention amount on this Project is \_\_\_\_\_ percent ( \_\_\_ %). \_\_\_\_\_

#### **ARTICLE V. CHANGES.**

Changes in this Agreement or in the Work to be done under this Agreement shall be made as provided in the General Conditions.

#### **ARTICLE VI. TERMINATION.**

The Owner or Contractor may terminate the Contract as provided in the General

{SR799843}4

Conditions.

## **ARTICLE VII. PREVAILING WAGES.**

The Project is a public work, the Work shall be performed as a public work and pursuant to the provisions of Section 1770 et seq. of the Labor Code of the State of California, which are hereby incorporated by reference and made a part hereof, the Director of Industrial Relations has determined the general prevailing rate of per diem wages and the general prevailing rate for holiday and overtime work in the locality in which the Work is to be performed, for each craft, classification or type of worker needed to execute this Contract. Per diem wages shall be deemed to include employer payments for health and welfare, pension, vacation, apprenticeship or other training programs, and similar purposes. Copies of the rates are on file at the Owner's principal office. The rate of prevailing wage for any craft, classification or type of workmanship to be employed on this Project is the rate established by the applicable collective bargaining agreement which rate so provided is hereby adopted by reference and shall be effective for the life of this Agreement or until the Director of the Department of Industrial Relations determines that another rate be adopted. It shall be mandatory upon the Contractor and on any subcontractor to pay not less than the said specified rates to all workers employed in the execution of this Agreement.

The Contractor and any subcontractor under the Contractor as a penalty to the Owner shall forfeit not more than Two Hundred Dollars (\$200.00) for each calendar day or portion thereof for each worker paid less than the stipulated prevailing rates for such work or craft in which such worker is employed. The difference between such stipulated prevailing wage rates and the amount paid to each worker for each calendar day or portion thereof for which each worker was paid less than the stipulated prevailing wage rate shall be paid to each worker by the Contractor.

The Contractor and each Subcontractor shall keep or cause to be kept an accurate record for Work on this Contract and Project showing the names, addresses, social security numbers, work classification, straight time and overtime hours worked and occupations of all laborers, workers and mechanics employed by them in connection with the performance of this Contract or any subcontract thereunder, and showing also the actual per diem wage paid to each of such workers, which records shall be open at all reasonable hours to inspection by the Owner, its officers and agents and to the representatives of the Division of Labor Standards Enforcement of the State Department of Industrial Relations. The Contractor and each subcontractor shall furnish a certified copy of all payroll records directly to the Labor Commissioner.

Public works projects shall be subject to compliance monitoring and enforcement by the Department of Industrial Relations. For all projects over Twenty-Five Thousand Dollars (\$25,000), a contractor or subcontractor shall not be qualified to submit a bid or



to be listed in a bid proposal subject to the requirements of Public Contract Code section 4104 unless currently registered and qualified under Labor Code section 1725.5 to perform public work as defined by Division 2, Part 7, Chapter 1 (§§1720 et seq.) of the Labor Code. For all projects over Twenty-Five Thousand Dollars (\$25,000), a contractor or subcontractor shall not be qualified to enter into, or engage in the performance of, any contract of public work (as defined by Division 2, Part 7, Chapter 1 (§§1720 et seq.) of the Labor Code) unless currently registered and qualified under Labor Code section 1725.5 to perform public work.

### **ARTICLE VIII. WORKING HOURS.**

In accordance with the provisions of Sections 1810 to 1815, inclusive, of the Labor Code of the State of California, which are hereby incorporated and made a part hereof, the time of service of any worker employed by the Contractor or a Subcontractor doing or contracting to do any part of the Work contemplated by this Agreement is limited and restricted to eight hours during any one calendar day and forty hours during any one calendar week, provided, that work may be performed by such employee in excess of said eight hours per day or forty hours per week provided that compensation for all hours worked in excess of eight hours per day, and forty hours per week, is paid at a rate not less than one and one-half (1½) times the basic rate of pay. The Contractor and every Subcontractor shall keep an accurate record showing the name of and the actual hours worked each calendar day and each calendar week by each worker employed by them in connection with the Work. The records shall be kept open at all reasonable hours to inspection by representatives of the Owner and the Division of Labor Law Enforcement. The Contractor shall as a penalty to the Owner forfeit Twenty-five Dollars (\$25.00) for each worker employed in the execution of this Agreement by the Contractor or by any subcontractor for each calendar day during which such worker is required or permitted to work more than eight hours in any one calendar day, and forty hours in any one calendar week, except as herein provided.

### **ARTICLE IX. APPRENTICES.**

The Contractor agrees to comply with Chapter 1, Part 7, Division 2, Sections 1777.5 and 1777.6 of the California Labor Code, which are hereby incorporated and made a part hereof. These sections require that contractors and subcontractors employ apprentices in apprenticeable occupations in a ratio of not less than one hour of apprentice's work for each five hours of work performed by a journeyman (unless an exemption is granted in accordance with Section 1777.5) and that contractors and subcontractors shall not discriminate among otherwise qualified employees as indentured apprentices on any public works solely on the ground of sex, race, religious creed, national origin, ancestry or color. Only apprentices as defined in Labor Code Section 3077, who are in training under apprenticeship standards and who have signed written apprentice agreements, will be employed on public works in apprenticeable occupations.

The responsibility for compliance with these provisions is fixed with the Contractor for all apprenticeable occupations.

#### **ARTICLE X. DSA OVERSIGHT PROCESS.**

The Contractor must comply with the applicable requirements of the Division of State Architect (“DSA”) Construction Oversight Process (“DSA Oversight Process”), including but not limited to (a) notifying the Owner’s Inspector of Record/Project Inspector (“IOR”) upon commencement and completion of each aspect of the Work as required under DSA Form 156; (b) coordinating the Work with the IOR’s inspection duties and requirements; (c) submitting verified reports under DSA Form 6-C; and (d) coordinating with the Owner, Owner’s Architect, any Construction Manager, any laboratories, and the IOR to meet the DSA Oversight Process requirements without delay or added costs to the Work or Project.

Contractor shall be responsible for any additional DSA fees related to review of proposed changes to the DSA-approved construction documents, to the extent the proposed changes were caused by Contractor’s wrongful act or omissions. If inspected Work is found to be in non-compliance with the DSA-approved construction documents or the DSA-approved testing and inspection program, then it must be removed and corrected. Any construction that covers unapproved or uninspected Work is subject to removal and correction, at Contractor’s expense, in order to permit inspection and approval of the covered work in accordance with the DSA Oversight Process.

#### **ARTICLE XI. INDEMNIFICATION AND INSURANCE.**

The Contractor will defend, indemnify and hold harmless the Owner, its governing board, officers, agents, trustees, employees and others as provided in the General Conditions.

By this statement the Contractor represents that it has secured the payment of Workers' Compensation in compliance with the provisions of the Labor Code of the State of California and during the performance of the work contemplated herein will continue so to comply with said provisions of said Code. The Contractor shall supply the Owner with certificates of insurance evidencing that Workers' Compensation Insurance is in effect and providing that the Owner will receive thirty (30) days' notice of cancellation.

Contractor shall provide the insurance set forth in the General Conditions. The amount of general liability insurance shall be One Million \$1,000,000 per occurrence for bodily injury, personal injury and property damage and the amount of automobile liability insurance shall be Two Million \$2,000,000 per accident for bodily injury and property damage combined single limit.

**ARTICLE XII. ENTIRE AGREEMENT.**

The Contract constitutes the entire agreement between the parties relating to the Work, and supersedes any prior or contemporaneous agreement between the parties, oral or written, including the Owner's award of the Contract to Contractor, unless such agreement is expressly incorporated herein. The Owner makes no representations or warranties, express or implied, not specified in the Contract. The Contract is intended as the complete and exclusive statement of the parties' agreement pursuant to Code of Civil Procedure section 1856.

**ARTICLE XIII. EXECUTION OF OTHER DOCUMENTS.**

The parties to this Agreement shall cooperate fully in the execution of any and all other documents and in the completion of any additional actions that may be necessary or appropriate to give full force and effect to the terms and intent of the Contract.

**ARTICLE XIV. EXECUTION IN COUNTERPARTS.**

This Agreement may be executed in counterparts such that the signatures may appear on separate signature pages. A copy, or an original, with all signatures appended together, shall be deemed a fully executed Agreement.

**ARTICLE XV. BINDING EFFECT.**

Contractor, by execution of this Agreement, acknowledges that Contractor has read this Agreement and the other Contract Documents, understands them, and agrees to be bound by their terms and conditions. The Contract shall inure to the benefit of and shall be binding upon the Contractor and the Owner and their respective successors and assigns.

**ARTICLE XVI. SEVERABILITY; GOVERNING LAW; CHOICE OF FORUM.**

If any provision of the Contract shall be held invalid or unenforceable by a court of competent jurisdiction, such holding shall not invalidate or render unenforceable any other provision hereof. The Contract shall be governed by the laws of the State of California. Any action or proceeding seeking any relief under or with respect to this Agreement shall be brought solely in the Superior Court of the State of California for the County of Alameda, subject to transfer of venue under applicable State law, provided that nothing in this Agreement shall constitute a waiver of immunity to suit by Owner.

**ARTICLE XVII. AMENDMENTS.**

{SR799843} 8

The terms of the Contract shall not be waived, altered, modified, supplemented or amended in any manner whatsoever except by written agreement, including a change order, signed by the parties and approved or ratified by the Governing Board.

**ARTICLE XVIII. ASSIGNMENT OF CONTRACT.**

The Contractor shall not assign or transfer by operation of law or otherwise any or all of its rights, burdens, duties or obligations without the prior written consent of the surety on the payment bond, the surety on the performance bond and the Owner.

**ARTICLE XIX. WRITTEN NOTICE.**

Written notice shall be deemed to have been duly served if delivered in person to the individual or member of the firm or to an officer of the corporation for whom it was intended, or if delivered at or sent by registered or certified or overnight mail to the last business address known to the person who gives the notice.

\_\_\_\_\_ (*CONTRACTOR*)                      **OAKLAND UNIFIED SCHOOL DISTRICT**

_____ _____ ( <i>Name</i> ) _____ (Chairman, Pres., or Vice-Pres.)	_____ _____ ( <i>Name</i> ) _____ ( <i>Title</i> )
--	--

\_\_\_\_\_  
 \_\_\_\_\_ (*Name*)  
 \_\_\_\_\_ (Secretary, Asst. Secretary, CFO, or Asst. Treasurer)

\_\_\_\_\_  
 CALIFORNIA CONTRACTOR'S  
 LICENSE NO.

\_\_\_\_\_  
 LICENSE EXPIRATION DATE

**NOTE:** Contractor must give the full business address of the Contractor and sign

{SR799843}9

with Contractor's usual signature. Partnerships must furnish the full name of all partners and the Agreement must be signed in the partnership name by a general partner with authority to bind the partnership in such matters, followed by the signature and designation of the person signing. The name of the person signing shall also be typed or printed below the signature. Corporations must sign with the legal name of the corporation, followed by the name of the state of incorporation and by the signature and designation of the chairman of the board, president or any vice president, and then followed by a second signature by the secretary, assistant secretary, the chief financial officer or assistant treasurer. All persons signing must be authorized to bind the corporation in the matter. The name of each person signing shall also be typed or printed below the signature. Satisfactory evidence of the authority of the officer signing on behalf of a corporation shall be furnished.

DO NOT COPY

*[for competitively bid projects over \$60,000]*

**AGREEMENT BETWEEN OWNER AND CONTRACTOR**

This Agreement, effective \_\_\_\_\_, 20\_\_, is by and between the Oakland Unified School District, in Alameda County, California, hereinafter called the “Owner,” and hereinafter called the “Contractor.”

**WITNESSETH:** That the Contractor and the Owner for the consideration hereinafter named agree as follows:

**ARTICLE I. SCOPE OF WORK.**

The Contractor agrees to furnish all labor, equipment and materials, including tools, implements, and appliances required, and to perform all the work required, by the Contract (the “Work”) in a good and workmanlike manner, free from any and all liens and claims from mechanics, material suppliers, subcontractors, artisans, machinists, teamsters, freight carriers, and laborers, and as specified in

the Various Sites Door Entry Systems Group 6 Project No 23127, at various sites. Sites: Thornhill Elementary School, Oakland Academy of Knowledge, Lockwood Steam Academy, Lockwood CDC, & Kaiser Early Childhood Center.

all in strict compliance with the plans, drawings and specifications therefore prepared by

Oakland Unified School District, Oakland, CA 94601, PH: 510-535-7044,

and other Contract Documents relating thereto.

The Contract as awarded includes the base scope of work only.

During the Work, the Contractor shall ensure that all Work, including but not limited to Work performed by Subcontractors, is performed in compliance with all applicable legal, contractual, and local government requirements related to COVID-19 and other public health emergencies, including “social distancing,” masks, and hygiene as may be ordered by the State or local authorities and as may be directed in the Contract Documents. In addition, the Contractor and its Subcontractors shall refer to specification section 01 35 13.23 (Site Standards and Covid Vaccination Requirements).

This contract **is not** subject to the District’s Project Labor Agreement. The full version of OUSD’s latest Project Labor Agreement can be found by going to the OUSD home page: [ousd.org](http://ousd.org) > Offices and Departs > Facilities Planning & Management Department > Click Opportunities drop-down > Project Labor Agreement(PLA) is at the

bottom.

## **ARTICLE II. CONTRACT DOCUMENTS.**

The Contractor and the Owner agree that all of the documents listed in Article 1.1.1 of the General Conditions form the “Contract Documents” which form the “Contract.” The Contractor and its subcontractors must use the Owner’s program software COLBI DOCS for projects.

## **ARTICLE III. TIME TO COMPLETE AND LIQUIDATED DAMAGES.**

Time is of the essence in this Contract, and the time of Completion for the Work (“the Contract Time”) shall be ninety (90) calendar days which shall start to run on (a) the date of commencement of the Work as established in the Owner’s Notice to Proceed, or (b) if no date of commencement is established in a Notice to Proceed from Owner, the date of Contractor’s actual commencement of the Work (including mobilization).

The site for the Contract will not be available to the Contractor for construction on the following dates: N/A. The Contractor shall not be entitled to time extensions for lack of access to the site on these dates.

Failure to Complete the Work within the Contract Time and in the manner provided for by the Contract Documents, or failure to complete any specified portion of the Work by a milestone deadline, shall subject the Contractor to liquidated damages. The actual occurrence of damages and the actual amount of the damages which the Owner would suffer if the Work were not Completed within the Contract Time, or if any specified portion of the Work were not completed by a milestone deadline, are dependent upon many circumstances and conditions which could prevail in various combinations and, from the nature of the case, it is impracticable and extremely difficult to fix the actual damages. Damages which the Owner would suffer in the event of such delay include, but are not limited to, loss of the use of the Work, disruption of activities, costs of administration and supervision, third party claims, and the incalculable inconvenience and loss suffered by the public.

Accordingly, the parties agree that \$1,000.00 per calendar day of delay shall be the damages which the Owner shall directly incur upon failure of the Contractor to Complete the Work within the Contract Time or Complete any specified portion of the Work by a milestone deadline, as described above. Liquidated damages will accrue for failure to meet milestone deadlines even if the Contractor Completes the Work within the Contract Time.

In addition, Contractor shall be subject to liquidated damages, or actual damages if liquidated damages are not recoverable under law, for causing another contractor on the Project to fail to timely complete its work under its contract or for causing delayed *completion* of the Project. The actual occurrence of damages and the actual amount of the

{SR799843}2

damages which the Owner would suffer if another contractor on the Project were to fail to timely complete its work under its contract or delay *completion* of the Project are dependent upon many circumstances and conditions which could prevail in various combinations and, from the nature of the case, it is impracticable and extremely difficult to fix the actual damages. Damages which the Owner would suffer in the event of such delay include, but are not limited to, loss of the use of the Work, loss of use of the other contractor's work, loss of use of the Project, disruption of activities, costs of administration and supervision, third party claims, the incalculable inconvenience and loss suffered by the public, and an Owner's inability to recover its delay damages from the contractors whose work was delayed by Contractor.

Accordingly, the parties agree that \$1,000.00 for each calendar day of delay shall be the amount of damages which the Owner shall directly incur upon Contractor causing another contractor on the Project to fail to timely complete its work under its contract or causing delayed *completion* of the Project.

For Contractor's obligations regarding claims against Owner from other contractors on the Project alleging that Contractor caused delays to their work, see General Conditions sections 3.7.4, 3.16 and 6.2.3.

If liquidated damages accrue as described above, the Owner, in addition to all other remedies provided by law, shall have the right to assess the liquidated damages at any time, and to withhold liquidated damages (and any interest thereon) at any time from any and all retention or progress payments, which would otherwise be or become due the Contractor. In addition, if it is reasonably apparent to the Owner before liquidated damages begin to accrue that they will accrue, Owner may assess and withhold, from retention or progress payments, the estimated amount of liquidated damages that will accrue in the future. If the retained percentage or withheld progress payments are not sufficient to discharge all liabilities of the Contractor incurred under this Article, the Contractor and its sureties shall continue to remain liable to the Owner until all such liabilities are satisfied in full.

If Owner accepts any work or makes any payment under the Contract Documents after a default by reason of delays, the payment or payments shall in no respect constitute a waiver or modification of any provision in the Contract Documents regarding time of Completion, milestone deadlines, or liquidated damages.

#### **ARTICLE IV. PAYMENT AND RETENTION.**

The Owner agrees to pay the Contractor in current funds \_\_\_\_\_ Dollars (\$ \_\_\_\_\_) for work satisfactorily performed after receipt of properly documented and submitted Applications for Payment and to make payments on account thereof, as provided in the General Conditions. Contract Documents other than special allowances. Any payment from an allowance is

{SR799843}3



entirely at the discretion, and only with the advanced written approval, of the Owner. To request payment from an Allowance, the Contractor must fully comply with the Contract Documents' requirements related to Notice to Potential Changes, Change Order Requests, and Claims, including but not limited to Articles 4 and 7 of the General Conditions and its provisions regarding waiver of rights for failure to comply. If the Owner approves in writing a payment from an Allowance, no change order approved by Owner's governing body shall be required, but Contractor must sign an Allowance expenditure form, after which the Contractor may include a request for such payment in its next progress payment application. Contractor's inclusion of a request for such payment in a progress payment application, or Contractor's acceptance of a progress payment that includes such payment, shall act as a full and complete waiver by Contractor of all rights to recover additional money related to the underlying basis of such payment; and such waiver shall be in addition to any other waiver that applies under the Contract Documents (including Article 4 of the General Conditions). If Contractor requests a time extension or other consideration in connection with or related to a requested payment from an Allowance, Contractor must comply with the Contract Documents' requirements related to Notice to Potential Changes, Change Order Requests, and Claims, including but not limited to Articles 4, 7, and 8 of the General Conditions and their provisions regarding waiver of rights for failure to comply, and no such time extension or other consideration may be issued until a change order is approved by the Owner's governing body pursuant to the Contract Documents. The amount of an Allowance may only be increased by a change order approved by Owner's governing body. Once an Allowance is fully spent, the Contractor must request any additional compensation pursuant to the procedures in the Contract Documents for Notices of Potential Claim, Change Order Requests, and Claims, and payment must be made by a change order approved by the Owner's governing body pursuant to the General Conditions. Upon Completion of the Work, all amounts in an Allowance that remain unspent and unencumbered shall remain the property of the Owner, Contractor shall have no claim to such funds, the Owner shall be entitled to a credit for such unused amounts against the above contract price, and the Owner may withhold such credit from any progress payment or release of retention.

The Owner has made a finding that this Project is substantially complex and requires a retention amount greater than 5%. (Public Contract Code section 7201.) The retention amount on this Project is \_\_\_\_\_ percent ( \_ %). \_\_\_\_\_

#### **ARTICLE V. CHANGES.**

Changes in this Agreement or in the Work to be done under this Agreement shall be made as provided in the General Conditions.

#### **ARTICLE VI. TERMINATION.**

The Owner or Contractor may terminate the Contract as provided in the General

{SR799843}4

Conditions.

## **ARTICLE VII. PREVAILING WAGES.**

The Project is a public work, the Work shall be performed as a public work and pursuant to the provisions of Section 1770 et seq. of the Labor Code of the State of California, which are hereby incorporated by reference and made a part hereof, the Director of Industrial Relations has determined the general prevailing rate of per diem wages and the general prevailing rate for holiday and overtime work in the locality in which the Work is to be performed, for each craft, classification or type of worker needed to execute this Contract. Per diem wages shall be deemed to include employer payments for health and welfare, pension, vacation, apprenticeship or other training programs, and similar purposes. Copies of the rates are on file at the Owner's principal office. The rate of prevailing wage for any craft, classification or type of workmanship to be employed on this Project is the rate established by the applicable collective bargaining agreement which rate so provided is hereby adopted by reference and shall be effective for the life of this Agreement or until the Director of the Department of Industrial Relations determines that another rate be adopted. It shall be mandatory upon the Contractor and on any subcontractor to pay not less than the said specified rates to all workers employed in the execution of this Agreement.

The Contractor and any subcontractor under the Contractor as a penalty to the Owner shall forfeit not more than Two Hundred Dollars (\$200.00) for each calendar day or portion thereof for each worker paid less than the stipulated prevailing rates for such work or craft in which such worker is employed. The difference between such stipulated prevailing wage rates and the amount paid to each worker for each calendar day or portion thereof for which each worker was paid less than the stipulated prevailing wage rate shall be paid to each worker by the Contractor.

The Contractor and each Subcontractor shall keep or cause to be kept an accurate record for Work on this Contract and Project showing the names, addresses, social security numbers, work classification, straight time and overtime hours worked and occupations of all laborers, workers and mechanics employed by them in connection with the performance of this Contract or any subcontract thereunder, and showing also the actual per diem wage paid to each of such workers, which records shall be open at all reasonable hours to inspection by the Owner, its officers and agents and to the representatives of the Division of Labor Standards Enforcement of the State Department of Industrial Relations. The Contractor and each subcontractor shall furnish a certified copy of all payroll records directly to the Labor Commissioner.

Public works projects shall be subject to compliance monitoring and enforcement by the Department of Industrial Relations. For all projects over Twenty-Five Thousand Dollars (\$25,000), a contractor or subcontractor shall not be qualified to submit a bid or

to be listed in a bid proposal subject to the requirements of Public Contract Code section 4104 unless currently registered and qualified under Labor Code section 1725.5 to perform public work as defined by Division 2, Part 7, Chapter 1 (§§1720 et seq.) of the Labor Code. For all projects over Twenty-Five Thousand Dollars (\$25,000), a contractor or subcontractor shall not be qualified to enter into, or engage in the performance of, any contract of public work (as defined by Division 2, Part 7, Chapter 1 (§§1720 et seq.) of the Labor Code) unless currently registered and qualified under Labor Code section 1725.5 to perform public work.

### **ARTICLE VIII. WORKING HOURS.**

In accordance with the provisions of Sections 1810 to 1815, inclusive, of the Labor Code of the State of California, which are hereby incorporated and made a part hereof, the time of service of any worker employed by the Contractor or a Subcontractor doing or contracting to do any part of the Work contemplated by this Agreement is limited and restricted to eight hours during any one calendar day and forty hours during any one calendar week, provided, that work may be performed by such employee in excess of said eight hours per day or forty hours per week provided that compensation for all hours worked in excess of eight hours per day, and forty hours per week, is paid at a rate not less than one and one-half (1½) times the basic rate of pay. The Contractor and every Subcontractor shall keep an accurate record showing the name of and the actual hours worked each calendar day and each calendar week by each worker employed by them in connection with the Work. The records shall be kept open at all reasonable hours to inspection by representatives of the Owner and the Division of Labor Law Enforcement. The Contractor shall as a penalty to the Owner forfeit Twenty-five Dollars (\$25.00) for each worker employed in the execution of this Agreement by the Contractor or by any subcontractor for each calendar day during which such worker is required or permitted to work more than eight hours in any one calendar day, and forty hours in any one calendar week, except as herein provided.

### **ARTICLE IX. APPRENTICES.**

The Contractor agrees to comply with Chapter 1, Part 7, Division 2, Sections 1777.5 and 1777.6 of the California Labor Code, which are hereby incorporated and made a part hereof. These sections require that contractors and subcontractors employ apprentices in apprenticeable occupations in a ratio of not less than one hour of apprentice's work for each five hours of work performed by a journeyman (unless an exemption is granted in accordance with Section 1777.5) and that contractors and subcontractors shall not discriminate among otherwise qualified employees as indentured apprentices on any public works solely on the ground of sex, race, religious creed, national origin, ancestry or color. Only apprentices as defined in Labor Code Section 3077, who are in training under apprenticeship standards and who have signed written apprentice agreements, will be employed on public works in apprenticeable occupations.

The responsibility for compliance with these provisions is fixed with the Contractor for all apprenticeable occupations.

#### **ARTICLE X. DSA OVERSIGHT PROCESS.**

The Contractor must comply with the applicable requirements of the Division of State Architect (“DSA”) Construction Oversight Process (“DSA Oversight Process”), including but not limited to (a) notifying the Owner’s Inspector of Record/Project Inspector (“IOR”) upon commencement and completion of each aspect of the Work as required under DSA Form 156; (b) coordinating the Work with the IOR’s inspection duties and requirements; (c) submitting verified reports under DSA Form 6-C; and (d) coordinating with the Owner, Owner’s Architect, any Construction Manager, any laboratories, and the IOR to meet the DSA Oversight Process requirements without delay or added costs to the Work or Project.

Contractor shall be responsible for any additional DSA fees related to review of proposed changes to the DSA-approved construction documents, to the extent the proposed changes were caused by Contractor’s wrongful act or omissions. If inspected Work is found to be in non-compliance with the DSA-approved construction documents or the DSA-approved testing and inspection program, then it must be removed and corrected. Any construction that covers unapproved or uninspected Work is subject to removal and correction, at Contractor’s expense, in order to permit inspection and approval of the covered work in accordance with the DSA Oversight Process.

#### **ARTICLE XI. INDEMNIFICATION AND INSURANCE.**

The Contractor will defend, indemnify and hold harmless the Owner, its governing board, officers, agents, trustees, employees and others as provided in the General Conditions.

By this statement the Contractor represents that it has secured the payment of Workers' Compensation in compliance with the provisions of the Labor Code of the State of California and during the performance of the work contemplated herein will continue so to comply with said provisions of said Code. The Contractor shall supply the Owner with certificates of insurance evidencing that Workers' Compensation Insurance is in effect and providing that the Owner will receive thirty (30) days' notice of cancellation.

Contractor shall provide the insurance set forth in the General Conditions. The amount of general liability insurance shall be One Million \$1,000,000 per occurrence for bodily injury, personal injury and property damage and the amount of automobile liability insurance shall be Two Million \$2,000,000 per accident for bodily injury and property damage combined single limit.

**ARTICLE XII. ENTIRE AGREEMENT.**

The Contract constitutes the entire agreement between the parties relating to the Work, and supersedes any prior or contemporaneous agreement between the parties, oral or written, including the Owner's award of the Contract to Contractor, unless such agreement is expressly incorporated herein. The Owner makes no representations or warranties, express or implied, not specified in the Contract. The Contract is intended as the complete and exclusive statement of the parties' agreement pursuant to Code of Civil Procedure section 1856.

**ARTICLE XIII. EXECUTION OF OTHER DOCUMENTS.**

The parties to this Agreement shall cooperate fully in the execution of any and all other documents and in the completion of any additional actions that may be necessary or appropriate to give full force and effect to the terms and intent of the Contract.

**ARTICLE XIV. EXECUTION IN COUNTERPARTS.**

This Agreement may be executed in counterparts such that the signatures may appear on separate signature pages. A copy, or an original, with all signatures appended together, shall be deemed a fully executed Agreement.

**ARTICLE XV. BINDING EFFECT.**

Contractor, by execution of this Agreement, acknowledges that Contractor has read this Agreement and the other Contract Documents, understands them, and agrees to be bound by their terms and conditions. The Contract shall inure to the benefit of and shall be binding upon the Contractor and the Owner and their respective successors and assigns.

**ARTICLE XVI. SEVERABILITY; GOVERNING LAW; CHOICE OF FORUM.**

If any provision of the Contract shall be held invalid or unenforceable by a court of competent jurisdiction, such holding shall not invalidate or render unenforceable any other provision hereof. The Contract shall be governed by the laws of the State of California. Any action or proceeding seeking any relief under or with respect to this Agreement shall be brought solely in the Superior Court of the State of California for the County of Alameda, subject to transfer of venue under applicable State law, provided that nothing in this Agreement shall constitute a waiver of immunity to suit by Owner.

**ARTICLE XVII. AMENDMENTS.**

{SR799843} 8

The terms of the Contract shall not be waived, altered, modified, supplemented or amended in any manner whatsoever except by written agreement, including a change order, signed by the parties and approved or ratified by the Governing Board.

**ARTICLE XVIII. ASSIGNMENT OF CONTRACT.**

The Contractor shall not assign or transfer by operation of law or otherwise any or all of its rights, burdens, duties or obligations without the prior written consent of the surety on the payment bond, the surety on the performance bond and the Owner.

**ARTICLE XIX. WRITTEN NOTICE.**

Written notice shall be deemed to have been duly served if delivered in person to the individual or member of the firm or to an officer of the corporation for whom it was intended, or if delivered at or sent by registered or certified or overnight mail to the last business address known to the person who gives the notice.

\_\_\_\_\_ (*CONTRACTOR*)                      **OAKLAND UNIFIED SCHOOL DISTRICT**

\_\_\_\_\_ (*Name*)    \_\_\_\_\_ (*Name*)  
\_\_\_\_\_ (*Chairman, Pres., or Vice-Pres.*)                      \_\_\_\_\_ (*Title*)

\_\_\_\_\_ (*Name*)  
\_\_\_\_\_ (*Secretary, Asst. Secretary, CFO, or Asst. Treasurer*)

\_\_\_\_\_  
CALIFORNIA CONTRACTOR'S  
LICENSE NO.

\_\_\_\_\_  
LICENSE EXPIRATION DATE

**NOTE:** Contractor must give the full business address of the Contractor and sign

{SR799843}9

with Contractor's usual signature. Partnerships must furnish the full name of all partners and the Agreement must be signed in the partnership name by a general partner with authority to bind the partnership in such matters, followed by the signature and designation of the person signing. The name of the person signing shall also be typed or printed below the signature. Corporations must sign with the legal name of the corporation, followed by the name of the state of incorporation and by the signature and designation of the chairman of the board, president or any vice president, and then followed by a second signature by the secretary, assistant secretary, the chief financial officer or assistant treasurer. All persons signing must be authorized to bind the corporation in the matter. The name of each person signing shall also be typed or printed below the signature. Satisfactory evidence of the authority of the officer signing on behalf of a corporation shall be furnished.

DO NOT COPY

**BID DOCUMENTATION TO BE HELD IN ESCROW**  
**DOCUMENT 00 53 00**

**1. Requirement to Escrow Bid Documentation**

- a. Contractor shall submit, within **TEN (10)** calendar days after the date of the Notice of Award, one copy of all documentary information received or generated by Contractor in preparation of bid prices for this Contract, as specified herein. This material is referred to herein as “Escrow Bid Documentation.” The Escrow Bid Documentation of the Contractor will be held in escrow for the duration of the Contract.
- b. Contractor agrees, as a condition of award of the Contract, that the Escrow Bid Documentation constitutes all written information used in the preparation of its bid, and that no other written bid preparation information shall be considered in resolving disputes or claims. Contractor also agrees that nothing in the Escrow Bid Documentation shall change or modify the terms or conditions of the Contract Documents.
- c. The Escrow Bid Documentation will not be opened by District except as indicated herein. The Escrow Bid Documentation will be used only for the resolution of change orders and claims disputes.
- d. Contractor's submission of the Escrow Bid Documentation, as with the bonds and insurance documents required, is considered an essential part of the Contract award. Should the Contractor fail to make the submission within the allowed time specified above, District may deem the Contractor to have failed to enter into the Contract, and the Contractor shall forfeit the amount of its bid security, accompanying the Contractor's bid, and District may award the Contract to the next lowest responsive responsible bidder.
- e. NO PAYMENTS WILL BE MADE, NOR WILL DISTRICT ACCEPT PROPOSED CHANGE ORDERS UNTIL THE ABOVE REQUIRED INFORMATION IS SUBMITTED AND APPROVED.
- f. The Escrow Bid Documentation shall be submitted in person by an authorized representative of the Contractor to the District.

**2. Ownership of Escrow Bid Documentation**

- a. The Escrow Bid Documentation is, and shall always remain, the property of Contractor, subject to review by District, as provided herein.
- b. Escrow Bid Documentation constitute trade secrets, not known outside Contractor's business, known only to a limited extent and only by a limited number of employees of Contractor, safeguarded while in Contractor's possession, extremely valuable to Contractor, and could be extremely valuable to Contractor's competitors by virtue of reflecting Contractor's contemplated techniques of construction. Subject to the provisions herein, District agrees to safeguard the Escrow Bid Documentation, and all information contained therein, against disclosure to the fullest extent permitted by law.



### 3. Format and Contents of Escrow Bid Documentation

- a. Contractor may submit Escrow Bid Documentation in its usual cost-estimating format; a standard format is not required. The Escrow Bid Documentation shall be submitted in the language (e.g., English) of the specification.
- b. Escrow Bid Documentation must clearly itemize the estimated costs of performing the work of each bid item contained in the bid schedule, separating bid items into sub-items as required to present a detailed cost estimate and allow a detailed cost review. The Escrow Bid Documentation shall include all subcontractor bids or quotes, supplier bids or quotes, quantity takeoffs, crews, equipment, calculations of rates of production and progress, copies of quotes from subcontractors and suppliers, and memoranda, narratives, add/deduct sheets, and all other information used by the Contractor to arrive at the prices contained in the bid proposal. Estimated costs should be broken down into Contractor's usual estimate categories such as direct labor, repair labor, equipment ownership and operation, expendable materials, permanent materials, and subcontract costs as appropriate. Plant and equipment and indirect costs should be detailed in the Contractor's usual format. The Contractor's allocation of indirect costs, contingencies, markup, and other items to each bid item shall be identified.
- c. All costs shall be identified. For bid items amounting to less than \$10,000, estimated unit costs are acceptable without a detailed cost estimate, provided that labor, equipment, materials, and subcontracts, as applicable, are included and provided that indirect costs, contingencies, and markup, as applicable, are allocated.
- d. Bid Documentation provided by District should not be included in the Escrow Bid Documentation unless needed to comply with the following requirements.

### 4. Submittal of Escrow Bid Documentation

- a. The Escrow Bid Documentation shall be submitted by the Contractor in a sealed container within **TEN (10)** calendar days after the date of the Notice of Award. The container shall be clearly marked on the outside with the Contractor's name, date of submittal, project name and the words "Escrow Bid Documentation – Intended to be opened in the presence of Authorized Representatives of Both District and Contractor".
- b. By submitting Escrow Bid Documentation, Contractor represents that the material in the Escrow Bid Documentation constitutes all the documentary information used in preparation of the bid and that the Contractor has personally examined the contents of the Escrow Bid Documentation container and has found that the documents in the container are complete.
- c. If Contractor's proposal is based upon subcontracting any part of the work, each subcontractor whose total subcontract price exceeds 5 percent of the total contract price proposed by Contractor, shall provide separate Escrow Documents to be included with those of Contractor. Those documents shall be opened and examined in the same manner and at the same time as the examination described above for Contractor.
- d. If Contractor wishes to subcontract any portion of the Work after award, District retains the right to require Contractor to submit Escrow Documents for the Subcontractor before the subcontract is approved.

## 5. Storage, Examination and Final Disposition of Escrow Bid Documentation

- a. The Escrow Bid Documentation will be placed in escrow, for the life of the Contract, in a mutually agreeable institution. The cost of storage will be paid by Contractor for the duration of the project until final Contract payment. The storage facilities shall be the appropriate size for all the Escrow Bid Documentation and located conveniently to both District's and Contractor's offices.
- b. The Escrow Bid Documentation shall be examined by both District and Contractor, at any time deemed necessary by either District or Contractor, to assist in the negotiation of price adjustments and change orders or the settlement of disputes and claims. In the case of legal proceedings, Escrow Bid Documentation shall be used subject to the terms of an appropriate protective order if requested by Contractor and ordered by a court of competent jurisdiction. Examination of the Escrow Bid Documentation is subject to the following conditions:
  - 1) As trade secrets, the Escrow Bid Documentation is proprietary and confidential to the extent allowed by law.
  - 2) District and Contractor shall each designate, in writing to the other party **SEVEN (7)** calendar days prior to any examination, the names of representatives who are authorized to examine the Escrow Bid Documentation. No other person shall have access to the Escrow Bid Documentation.
  - 3) Access to the documents may take place only in the presence of duly designated representatives of the District and Contractor. If Contractor fails to designate a representative or appear for joint examination on **SEVEN (7)** calendar days' notice, then the District representative may examine the Escrow Bid Documents alone upon an additional **THREE (3)** calendar days' notice if a representative of the Contractor does not appear at the time set.
  - 4) If a subcontractor has submitted sealed information to be included in the Escrow Bid Documents, access to those documents may take place only in the presence of a duly designated representative of the District, Contractor and that subcontractor. If that subcontractor fails to designate a representative or appear for joint examination on **SEVEN (7)** calendar days' notice, then the District representative and/or the Contractor may examine the Escrow Bid Documentation without that subcontractor present upon an additional **THREE (3)** calendar days' notice if a representative of that subcontractor does not appear at the time set.
- c. The Escrow Bid Documentation will be returned to Contractor at such time as the Contract has been completed and final settlement has been achieved.

END OF DOCUMENT

**This is a fiduciary account created by statute, Public Contract Code section 22300. The funds deposited in this account shall not be released to Contractor or any other person or entity, other than Owner, including pursuant to any purported lien or writ of attachment or execution, without the prior written, express approval of Owner.**

**ESCROW AGREEMENT FOR  
SECURITY DEPOSITS IN LIEU OF RETENTION  
DOCUMENT 00 53 01**

This Escrow Agreement is made and entered into by and between the Oakland Unified School District, whose address is \_\_\_\_\_ (hereinafter called "Owner"); \_\_\_\_\_, whose address is \_\_\_\_\_ (hereinafter called "Contractor"); and \_\_\_\_\_, a state or federally chartered bank in California whose address is \_\_\_\_\_ (hereinafter called "Escrow Agent").

For the consideration hereinafter set forth, the Owner, Contractor, and Escrow Agent agree as follows:

1. Pursuant to section 22300 of the Public Contract Code of the State of California, Contractor has the option to deposit securities with Escrow Agent as a substitute for retention earnings required to be withheld by the Owner pursuant to the contract between the Owner and Contractor in the amount of \_\_\_\_\_ Dollars (\$ \_\_\_\_\_), and dated \_\_\_\_\_, 20 \_\_, for the \_\_\_\_\_ scope of work (the "Contract"). Alternatively, on written request of the Contractor, the Owner shall make payments of the retention earnings directly to the Escrow Agent. When Contractor deposits the securities as a substitute for retention earnings, the Escrow Agent shall notify the Owner within ten (10) calendar days of the deposit. The market value of the securities at the time of the substitution, as valued by the Owner, shall be at least equal to the cash amount then required to be withheld as retention under the terms of the Contract between the Owner and Contractor. If the Owner determines that the securities are not adequate it will notify Contractor and Escrow Agent, and Contractor shall deposit additional security as further determined by the Owner. Securities shall be held in the name of the Owner and shall designate the Contractor as the beneficial owner.
2. Thereafter, Owner shall make progress payments to the Contractor for such funds which otherwise would be withheld from progress payments pursuant to the Contract provisions, provided that the Escrow Agent holds securities in the form and amount specified above.
3. Pursuant to Public Contract Code section 22300, as an alternative to the procedures set forth above, Contractor may request in writing that the Owner pay retention amounts directly to Escrow Agent. When the Owner makes payment of

retentions earned directly to the Escrow Agent, the Escrow Agent shall hold them for benefit of the Contractor until such time as the escrow created under this Escrow Agreement is terminated. The Contractor may direct the investment of the payments into securities. All terms and conditions of this Escrow Agreement and the rights and responsibilities of the parties shall be equally applicable and binding when the Owner pays the Escrow Agent directly.

4. The Contractor shall be responsible for paying all fees for the expenses incurred by Escrow Agent in administering the Escrow Account and all expenses of the Owner. These expenses and payment terms shall be determined by the Owner, Contractor and Escrow Agent.
5. The interest earned on the securities, or the money market accounts held in escrow and all interest earned on that interest shall be for the sole account of Contractor and shall be subject to withdrawal by Contractor at any time and from time to time without notice to the Owner.
6. Contractor shall have the right to withdraw all or any part of the principal in the Escrow Account only by written notice to Escrow Agent accompanied by written authorization from Owner to the Escrow Agent that Owner consents to the withdrawal of the amount sought to be withdrawn by Contractor.
7. The Owner shall have the right to draw upon the securities or any amount paid directly to Escrow Agent in the event of default by the Contractor. Upon seven (7) days written notice to the Escrow Agent from the Owner of the default, the Escrow Agent shall immediately convert the securities to cash and shall distribute the cash, including any amounts paid directly to Escrow Agent pursuant to Section 3 above, as instructed by Owner. Escrow Agent shall not be concerned with the validity of any notice of default given by Owner pursuant to this paragraph, and shall promptly comply with Owner's instructions to pay over said escrowed assets. Escrow Agent further agrees to not interplead the escrowed assets in response to a conflicting demand and hereby waives any present or future opportunity of interpleader.
8. Upon receipt of written notification from the Owner certifying that the Contract is final and complete, and that the Contractor has complied with all requirements and procedures applicable to the Contract, Escrow Agent shall release to Contractor all securities and interest on deposit less escrow fees and charges of the Escrow Account. The escrow shall be closed immediately upon disbursement of all moneys and securities on deposit and payment of fees and charges.
9. Escrow Agent shall rely on the written notifications from the Owner and Contractor pursuant to Sections (4), (5), (6), (7) and (8) of this Agreement and the Owner and Contractor shall hold Escrow Agent harmless from Escrow Agent's release and disbursement of the securities and interest as set forth above.

10. The names of the persons who are authorized to give written notice or to receive written notice on behalf of the Owner, the Contractor and the Escrow Agent in connection with the foregoing, and exemplars of their respective signatures are as follows:

ON BEHALF OF OWNER:

\_\_\_\_\_  
Signature

\_\_\_\_\_  
Typewritten Name

\_\_\_\_\_  
Title

ON BEHALF OF CONTRACTOR:

\_\_\_\_\_  
Signature

\_\_\_\_\_  
Typewritten Name

\_\_\_\_\_  
Title

ON BEHALF OF ESCROW AGENT:

\_\_\_\_\_  
Signature

\_\_\_\_\_  
Typewritten Name

\_\_\_\_\_  
Title

**IN WITNESS WHEREOF**, the parties have executed this Agreement by their proper officers on the date first set forth above.

OWNER:

\_\_\_\_\_  
Signature

\_\_\_\_\_  
Typewritten Name

\_\_\_\_\_  
Title

CONTRACTOR:

\_\_\_\_\_  
Signature

\_\_\_\_\_  
Typewritten Name

\_\_\_\_\_  
Title

ESCROW AGENT:

\_\_\_\_\_  
Signature

\_\_\_\_\_  
Typewritten Name

\_\_\_\_\_  
Title

At the time the Escrow Account is opened, the Owner and Contractor shall deliver to the Escrow Agent a fully executed counterpart of this Agreement.

**PERFORMANCE BOND**  
**DOCUMENT 00 61 00**

Bond Number: \_\_\_\_\_

**KNOW ALL MEN BY THESE PRESENTS** that we, \_\_\_\_\_,  
as Principal, and \_\_\_\_\_, as Surety, are held and firmly bound  
unto the Oakland Unified School District, in the County of Alameda, State of California,  
hereinafter called the "Owner," in the sum of \_\_\_\_\_  
Dollars (\$ \_\_\_\_\_) for the payment of which sum well and truly made, we bind  
ourselves, our heirs, executors, administrators, and successors, jointly and severally, to  
the Owner for the full performance of a certain contract with the Owner, the terms of  
which are incorporated herein by reference, dated **January 11, 2024**, for construction of

**the Various Sites Door Entry Systems Group 5 Project 23126, (the "Contract")**. The  
Scope of work for Group 5 includes: Installation of AIPhone door entry intercom  
systems at various sites. Sites: Oakland Tech Upper Campus, Montera Middle School,  
Jefferson CDC, Hillcrest Elementary School, & Bella Vista CDC.

The condition of this obligation is such that, if the Principal shall well and truly  
perform and fulfill all the undertakings, covenants, terms, conditions, and agreements of  
said Contract during the original term of said Contract and any extensions thereof that  
may be granted by the Owner, with or without notice to the Surety, and for the period of  
time specified in the Contract after completion for correction of faulty or improper  
materials and workmanship and during the life of any guaranty or warranty required  
under the Contract, and shall also well and truly perform and fulfill all the undertakings,  
covenants, terms, conditions and agreement of any and all duly authorized modifications  
of said Contract that may hereafter be made, then this obligation is to be void, otherwise  
to remain in full force and virtue.

And the said Surety, for value received, hereby stipulates and agrees that no  
change, extension of time, alteration or addition to the terms of the Contract or to the  
Work to be performed thereunder or the specifications accompanying the same, shall in  
any way affect its obligation on this bond, and it does hereby waive notice of any such  
change, extension of time, alteration or addition to the terms of the Contract, or to the  
Work, or to the specifications.

No further agreement between Surety and Owner shall be required as a  
prerequisite to the Surety performing its obligations under this bond. In the event that the  
Surety elects to complete the Work of the Contract after termination of the Contract by  
Owner, the Surety may not hire Principal, or any of Principal's owners, employees, or  
subcontractors, to perform the Work without the written consent of Owner, and the  
Owner may grant or withhold such consent within its sole discretion.

{SR798942} 1

**IN WITNESS WHEREOF**, the above-bounden parties have executed this instrument under their several seals this \_\_\_\_\_ day of \_\_\_\_\_, 20\_\_\_\_, hereto affixed and these presents duly signed by its undersigned representative, pursuant to authority of its governing body.

(To be signed by \_\_\_\_\_ )  
(Principal and Surety, \_\_\_\_\_ )  
(and acknowledged and \_\_\_\_\_ )  
(Notarial Seal attached \_\_\_\_\_ )

(Affix Corporate Seal)

\_\_\_\_\_  
(Individual Principal)

\_\_\_\_\_  
(Business Address)

(Affix Corporate Seal)

\_\_\_\_\_  
(Corporate Principal)

\_\_\_\_\_  
(Business Address)

(Affix Corporate Seal)

\_\_\_\_\_  
(Corporate Surety)

\_\_\_\_\_  
(Business Address)

By: \_\_\_\_\_

The rate of premium on this bond is \_\_\_\_\_ per thousand.

The total amount of premium charged is \_\_\_\_\_.

The above must be filled in by Corporate Surety.

{SR798942}2



**PERFORMANCE BOND**  
**DOCUMENT 00 61 00**

Bond Number: \_\_\_\_\_

**KNOW ALL MEN BY THESE PRESENTS** that we, \_\_\_\_\_,  
as Principal, and \_\_\_\_\_, as Surety, are held and firmly bound  
unto the Oakland Unified School District, in the County of Alameda, State of California,  
hereinafter called the "Owner," in the sum of \_\_\_\_\_  
Dollars (\$ \_\_\_\_\_) for the payment of which sum well and truly made, we bind  
ourselves, our heirs, executors, administrators, and successors, jointly and severally, to  
the Owner for the full performance of a certain contract with the Owner, the terms of  
which are incorporated herein by reference, dated **January 11, 2024**, for construction of

**the Various Sites Door Entry Systems Group 6 Project No 23127, (the "Contract").**  
The Scope of work for Group 6 includes: Installation of AIPhone door entry intercom  
systems at various sites. Sites: Thornhill Elementary School, Oakland Academy of  
Knowledge, Lockwood Steam Academy, Lockwood CDC, & Kaiser Early Childhood  
Center.

The condition of this obligation is such that, if the Principal shall well and truly  
perform and fulfill all the undertakings, covenants, terms, conditions, and agreements of  
said Contract during the original term of said Contract and any extensions thereof that  
may be granted by the Owner, with or without notice to the Surety, and for the period of  
time specified in the Contract after completion for correction of faulty or improper  
materials and workmanship and during the life of any guaranty or warranty required  
under the Contract, and shall also well and truly perform and fulfill all the undertakings,  
covenants, terms, conditions and agreement of any and all duly authorized modifications  
of said Contract that may hereafter be made, then this obligation is to be void, otherwise  
to remain in full force and virtue.

And the said Surety, for value received, hereby stipulates and agrees that no  
change, extension of time, alteration or addition to the terms of the Contract or to the  
Work to be performed thereunder or the specifications accompanying the same, shall in  
any way affect its obligation on this bond, and it does hereby waive notice of any such  
change, extension of time, alteration or addition to the terms of the Contract, or to the  
Work, or to the specifications.

No further agreement between Surety and Owner shall be required as a  
prerequisite to the Surety performing its obligations under this bond. In the event that the  
Surety elects to complete the Work of the Contract after termination of the Contract by  
Owner, the Surety may not hire Principal, or any of Principal's owners, employees, or  
subcontractors, to perform the Work without the written consent of Owner, and the  
Owner may grant or withhold such consent within its sole discretion.

{SR798942} 1

**IN WITNESS WHEREOF**, the above-bounden parties have executed this instrument under their several seals this \_\_\_\_\_ day of \_\_\_\_\_, 20\_\_, hereto affixed and these presents duly signed by its undersigned representative, pursuant to authority of its governing body.

(To be signed by \_\_\_\_\_ )  
(Principal and Surety, \_\_\_\_\_ )  
(and acknowledged and \_\_\_\_\_ )  
(Notarial Seal attached \_\_\_\_\_ )

(Affix Corporate Seal)

\_\_\_\_\_  
(Individual Principal)

\_\_\_\_\_  
(Business Address)

(Affix Corporate Seal)

\_\_\_\_\_  
(Corporate Principal)

\_\_\_\_\_  
(Business Address)

(Affix Corporate Seal)

\_\_\_\_\_  
(Corporate Surety)

\_\_\_\_\_  
(Business Address)

By: \_\_\_\_\_  
\_\_\_\_\_

The rate of premium on this bond is \_\_\_\_\_ per thousand.

The total amount of premium charged is \_\_\_\_\_.

The above must be filled in by Corporate Surety.

{SR798942}2

**PAYMENT BOND**  
**DOCUMENT 00 61 01**  
**(Labor and Material)**

Bond Number: \_\_\_\_\_

**KNOW ALL MEN BY THESE PRESENTS:**

That WHEREAS, the Oakland Unified School District (the "Owner" of the public works contract described below) and \_\_\_\_\_, hereinafter designated as the "Principal," have entered into a Contract for the furnishing of all materials and labor, services and transportation, necessary, convenient, and proper to construct

**the Various Sites Door Entry Systems Group 5 Project No 23126**, the Scope of work for Group 5 includes: Installation of AIPhone door entry intercom systems at various sites. Sites: Oakland Tech Upper Campus, Montera Middle School, Jefferson CDC, Hillcrest Elementary School, & Bella Vista CDC.

which said agreement dated **January 11, 2024**, and all of the Contract Documents are hereby referred to and made a part hereof;

and

WHEREAS, the Principal is required, before entering upon the performance of the work, to file a good and sufficient bond with the body by whom the Contract is awarded to secure the claims arising under said agreement.

**NOW, THEREFORE, THESE PRESENTS WITNESSETH:**

That the said Principal and the undersigned \_\_\_\_\_ ("Surety") are held and firmly bound unto all laborers, material men, and other persons, and bound for all amounts due, referred to in Civil Code section 9554, subdivision (b), in the sum of \_\_\_\_\_ Dollars (\$ \_\_\_\_\_) which sum well and truly be made, we bind ourselves, our heirs, executors, administrators, successors, or assigns, jointly and severally, by these presents.

The condition of this obligation is that if the said Principal or any of its subcontractors, or the heirs, executors, administrators, successors, or assigns of any, all, or either of them, shall fail to pay any of the persons named in Civil Code section 9100, or any of the amounts due, as specified in Civil Code section 9554, subdivision (b), that said Surety will pay the same in an amount not exceeding the amount hereinabove set forth, and also in case suit is brought upon this bond, will pay costs and reasonable attorney's fees to be

{SR798938} 1

awarded and fixed by the Court, and to be taxed as costs and to be included in the judgment therein rendered.

It is hereby expressly stipulated and agreed that this bond shall inure to the benefit of any and all persons, companies, and corporations entitled to file claims so as to give a right of action to them or their assigns in any suit brought upon this bond.

Should the condition of this bond be fully performed, then this obligation shall become null and void, otherwise it shall be and remain in full force and effect.

And the said Surety, for value received, thereby stipulates and agrees that no change, extension of time, alteration, or addition to the terms of said contract or the specifications accompanying the same shall in any manner affect its obligations on this bond, and it does hereby waive notice of any such change, extension, alteration, or addition.

IN WITNESS WHEREOF, this instrument has been duly executed by the Principal and Surety this \_\_\_\_\_ day of \_\_\_\_\_, 20\_\_.

(To be signed by \_\_\_\_\_ )  
(Principal and Surety, \_\_\_\_\_ )  
(and acknowledged and \_\_\_\_\_ )  
(Notarial Seal attached \_\_\_\_\_ )

\_\_\_\_\_  
Principal

\_\_\_\_\_  
Surety

By: \_\_\_\_\_  
Attorney-in-Fact

The above bond is accepted and approved this \_\_\_\_\_ day of \_\_\_\_\_.

{SR798938}2

**PAYMENT BOND**  
**DOCUMENT 00 61 01**  
**(Labor and Material)**

Bond Number: \_\_\_\_\_

**KNOW ALL MEN BY THESE PRESENTS:**

That WHEREAS, the Oakland Unified School District (the "Owner" of the public works contract described below) and \_\_\_\_\_, hereinafter designated as the "Principal," have entered into a Contract for the furnishing of all materials and labor, services and transportation, necessary, convenient, and proper to construct

**the Various Sites Door Entry Systems Group 6 Project 23127**, The Scope of work for Group 6 includes: Installation of AIPhone door entry intercom systems at various sites. Sites: Thornhill Elementary School, Oakland Academy of Knowledge, Lockwood Steam Academy, Lockwood CDC, & Kaiser Early Childhood Center.

which said agreement dated **January 11, 2024**, and all of the Contract Documents are hereby referred to and made a part hereof;

and

WHEREAS, the Principal is required, before entering upon the performance of the work, to file a good and sufficient bond with the body by whom the Contract is awarded to secure the claims arising under said agreement.

**NOW, THEREFORE, THESE PRESENTS WITNESSETH:**

That the said Principal and the undersigned \_\_\_\_\_ ("Surety") are held and firmly bound unto all laborers, material men, and other persons, and bound for all amounts due, referred to in Civil Code section 9554, subdivision (b), in the sum of \_\_\_\_\_ Dollars (\$ \_\_\_\_\_) which sum well and truly be made, we bind ourselves, our heirs, executors, administrators, successors, or assigns, jointly and severally, by these presents.

The condition of this obligation is that if the said Principal or any of its subcontractors, or the heirs, executors, administrators, successors, or assigns of any, all, or either of them, shall fail to pay any of the persons named in Civil Code section 9100, or any of the amounts due, as specified in Civil Code section 9554, subdivision (b), that said Surety will pay the same in an amount not exceeding the amount hereinabove set forth, and also in case suit is brought upon this bond, will pay costs and reasonable attorney's fees to be

{SR798938} 1

awarded and fixed by the Court, and to be taxed as costs and to be included in the judgment therein rendered.

It is hereby expressly stipulated and agreed that this bond shall inure to the benefit of any and all persons, companies, and corporations entitled to file claims so as to give a right of action to them or their assigns in any suit brought upon this bond.

Should the condition of this bond be fully performed, then this obligation shall become null and void, otherwise it shall be and remain in full force and effect.

And the said Surety, for value received, thereby stipulates and agrees that no change, extension of time, alteration, or addition to the terms of said contract or the specifications accompanying the same shall in any manner affect its obligations on this bond, and it does hereby waive notice of any such change, extension, alteration, or addition.

IN WITNESS WHEREOF, this instrument has been duly executed by the Principal and Surety this \_\_\_\_\_ day of \_\_\_\_\_, 20\_\_.

(To be signed by \_\_\_\_\_ )  
(Principal and Surety, \_\_\_\_\_ )  
(and acknowledged and \_\_\_\_\_ )  
(Notarial Seal attached \_\_\_\_\_ )

\_\_\_\_\_  
Principal

\_\_\_\_\_  
Surety

By: \_\_\_\_\_  
Attorney-in-Fact

The above bond is accepted and approved this \_\_\_\_ day of \_\_\_\_\_.

{SR798938}2

**GENERAL CONDITIONS**  
**for**  
**CONTRACT OF CONSTRUCTION**

**FOR VARIOUS SITES DOOR ENTRY SYSTEMS GROUP 5 & 6 PROJECT**

**OAKLAND UNIFIED SCHOOL DISTRICT**

**January 11, 2024**

**SUMMARY OF CONTENTS**

ARTICLE 1: GENERAL CONDITIONS .....1

ARTICLE 2: OWNER .....7

ARTICLE 3: THE CONTRACTOR .....10

ARTICLE 4: ADMINISTRATION OF THE CONTRACT .....30

ARTICLE 5: SUBCONTRACTORS .....47

ARTICLE 6: CONSTRUCTION BY OWNER OR BY SEPARATE CONTRACTORS .....53

ARTICLE 7: CHANGES IN THE WORK .....55

ARTICLE 8: TIME .....63

ARTICLE 9: PAYMENTS AND COMPLETION .....68

ARTICLE 10: PROTECTION OF PERSONS AND PROPERTY .....79

ARTICLE 11: INSURANCE AND BONDS .....85

ARTICLE 12: UNCOVERING AND CORRECTION OF WORK .....91

ARTICLE 13: MISCELLEOUS PROVISIONS .....93

ARTICLE 14: TERMINATION OR SUSPENSION OF THE CONTRACT .....105



**TABLE OF CONTENTS**

ARTICLE 1 .....	1	2.2	INFORMATION AND SERVICES REQUIRED OF THE OWNER .....	7
GENERAL CONDITIONS .....	1	2.2.1	INTENTIONALLY LEFT BLANK .....	7
1.1 BASIC DEFINITIONS .....	1	2.2.2	SITE SURVEY .....	7
1.1.1 THE CONTRACT DOCUMENTS.....	1	2.2.3	SOILS.....	7
1.1.2 THE CONTRACT.....	1	2.2.3.1	<i>Owner Furnished Services</i> .....	7
1.1.3 THE WORK .....	1	2.2.3.2	<i>Contractor Reliance</i> .....	7
1.1.4 THE PROJECT .....	2	2.2.4	UTILITY SURVEY .....	8
1.1.5 THE DRAWINGS.....	2	2.2.5	INFORMATION.....	8
1.1.6 THE SPECIFICATIONS.....	2	2.2.6	EXISTING UTILITY LINES; REMOVAL, RELOCATION .....	8
1.1.7 THE PROJECT MANUAL .....	2	2.2.6.1	<i>Removal, Relocation</i> .....	8
1.1.8 OR 2		2.2.6.2	<i>Assessment</i> .....	8
1.1.9 COMPLETION.....	2	2.2.6.3	<i>Notification</i> .....	8
1.1.10 COMPLETION .....	3	2.2.6.4	<i>Underground Utility Clearance</i>	9
1.2 EXECUTION, CORRELATION AND INTENT .....	3	2.2.7	EASEMENTS .....	9
1.2.1 CORRELATION AND INTENT.....	3	2.2.8	REASONABLE PROMPTNESS .....	9
1.2.1.1 <i>Documents Complementary and Inclusive</i> 3		2.2.9	COPIES FURNISHED.....	9
1.2.1.2 <i>Coverage of the Drawings and Specifications</i> .....	3	2.2.10	DUTIES CUMULATIVE .....	9
1.2.1.3 <i>Conflicts</i> .....	3	2.3	OWNER’S RIGHT TO STOP THE WORK.....	9
1.2.1.4 <i>Conformance With Laws</i> .....	3	2.4	OWNER’S RIGHT TO CARRY OUT THE WORK .....	9
1.2.1.5 <i>Ambiguity</i> .....	4	ARTICLE 3 .....	10	
1.2.1.6 <i>Execution</i> .....	4	THE CONTRACTOR.....	10	
1.2.2 ADDENDA AND DEFERRED APPROVALS	5	3.1	DEFINITION .....	10
1.2.2.1 <i>Addenda</i> .....	5	3.2	SUPERVISION AND CONSTRUCTION PROCEDURES .....	10
1.2.2.2 <i>Deferred Approvals</i> .....	5	3.2.1	CONTRACTOR .....	10
1.2.3 SPECIFICATION INTERPRETATION .....	5	3.2.2	CONTRACTOR RESPONSIBILITY .....	11
1.2.3.1 <i>Titles</i> .....	5	3.2.3	OBLIGATIONS NOT CHANGED BY OTHER’S ACTIONS.....	11
1.2.3.2 <i>As Shown, Etc</i> .....	5	3.2.4	CONTRACTOR RESPONSIBILITY FOR READINESS FOR WORK .....	11
1.2.3.3 <i>Provide</i> .....	5	3.2.5	PROJECT MEETINGS.....	11
1.2.3.4 <i>General Conditions</i> .....	5	3.3	SUPERINTENDENT .....	11
1.2.3.5 <i>Abbreviations</i> .....	5	3.3.1	FULL TIME SUPERINTENDENT.....	11
1.2.3.6 <i>Plural</i> .....	5	3.3.2	STAFF .....	12
1.2.3.7 <i>Metric</i> .....	5	3.3.3	RIGHT TO REMOVE .....	12
1.2.3.8 <i>Standard Specifications</i> .....	6	3.4	LABOR AND MATERIALS .....	12
1.2.3.9 <i>Absence of Modifiers</i> .....	6	3.4.1	CONTRACTOR TO PROVIDE .....	12
1.3 OWNERSHIP AND USE OF ARCHITECT’S DRAWINGS, SPECIFICATIONS AND OTHER DOCUMENTS .....	6	3.4.2	QUALITY .....	12
ARTICLE 2 .....	7	3.4.3	REPLACEMENT.....	12
OWNER 7		3.4.4	DISCIPLINE .....	13
2.1 DEFINITION .....	7			

3.5	WARRANTY.....	13	3.11.4.3	<i>Substitution Request Form</i> .....	22
3.6	TAXES.....	13	3.11.4.4	<i>List of Manufacturers and Products Required</i> .....	22
3.7	PERMITS, FEES AND NOTICES.....	13	3.11.5	DEFERRED APPROVALS .....	23
3.7.1	PAYMENT .....	13	3.12	CUTTING AND PATCHING .....	23
3.7.2	COMPLIANCE.....	13	3.12.1	SCOPE.....	23
3.7.3	CONTRACT DOCUMENTS .....	14	3.12.2	CONSENT .....	23
3.7.4	RESPONSIBILITY .....	14	3.12.3	STRUCTURAL MEMBERS .....	23
3.8	ALLOWANCES .....	14	3.12.4	Subsequent Removal .....	23
3.8.1	CONTRACT .....	14	3.13	CLEANING UP .....	24
3.8.2	SCOPE .....	14	3.13.1	CONTRACTOR’S RESPONSIBILITY .....	24
3.8.2.1	<i>Prompt Selection</i> .....	14	3.13.2	FAILURE TO CLEANUP .....	24
3.8.2.2	<i>Cost</i> .....	14	3.13.3	CONSTRUCTION BUILDINGS.....	24
3.8.2.3	<i>Cost Included in Contract Sum</i> ..	14	3.14	ACCESS TO WORK.....	24
3.8.2.4	<i>Contract Sum Adjustment</i> .....	14	3.15	ROYALTIES AND PATENTS .....	24
3.9	CONTRACTOR’S CONSTRUCTION SCHEDULES.....	15	3.15.1	PAYMENT AND INDEMNITY .....	24
3.9.1	Requirements.....	15	3.15.2	REVIEW .....	25
3.9.2	DSA OVERSIGHT PROCESS.....	17	3.16	INDEMNIFICATION .....	25
3.9.3	FAILURE TO MEET REQUIREMENTS .....	17	3.16.1	SCOPE: CONTRACTOR.....	25
3.10	DOCUMENTS AND SAMPLES AT THE SITE.....	17	3.16.2	SCOPE: SUBCONTRACTORS .....	25
3.11	SHOP DRAWINGS, PRODUCT DATA, AND SAMPLES .....	18	3.16.2.1	<i>Indemnity</i> .....	25
3.11.1	SUBMITTALS DEFINED .....	18	3.16.2.2	<i>Joint and Several Liability</i> .....	26
3.11.1.1	<i>Shop Drawings</i> .....	18	3.16.3	No LIMITATION .....	26
3.11.1.2	<i>Samples</i> .....	18	3.17	OWNER AS INTENDED BENEFICIARY.....	26
3.11.1.3	<i>Contractor’s Responsibility</i> .....	18	3.18	NOTICE OF EXCUSE FOR NONPERFORMANCE .....	27
3.11.1.4	<i>Extent of Review</i> .....	19	3.19	RECOVERY OF COSTS, DAMAGES, OR TIME EXTENSIONS FROM OWNER.....	27
3.11.2	DRAWING SUBMISSION PROCEDURE ....	19	3.20	USE OF FEDERAL FUNDS .....	27
3.11.2.1	<i>Transmittal Letter and Other Requirements</i> .....	19	ARTICLE 4.....	30	
3.11.2.2	<i>Copies Required</i> .....	20	ADMINISTRATION OF THE CONTRACT	30	
3.11.2.3	<i>Corrections</i> .....	20	4.1	ARCHITECT .....	30
3.11.2.4	<i>Approval Prior to Commencement of Work</i> .....	20	4.1.1	DEFINITION.....	30
3.11.3	SAMPLE SUBMISSIONS PROCEDURE.....	20	4.1.2	MODIFICATION .....	30
3.11.3.1	<i>Samples Required</i> .....	20	4.1.3	TERMINATION.....	30
3.11.3.2	<i>Labels and Instructions</i> .....	20	4.2	ARCHITECT’S ADMINISTRATION OF THE CONTRACT .....	30
3.11.3.3	<i>Architect’s Review</i> .....	21	4.2.1	STATUS.....	30
3.11.3.4	<i>Record Drawings and Annotated Specifications</i> .....	21	4.2.2	SITE VISITS.....	31
3.11.3.5	<i>Equipment Manuals</i> .....	21	4.2.3	LIMITATIONS OF CONSTRUCTION RESPONSIBILITY .....	31
3.11.3.6	<i>Owner’s Property</i> .....	21	4.2.4	COMMUNICATIONS FACILITATING CONTRACT ADMINISTRATION.....	31
3.11.4	SUBSTITUTIONS .....	21	4.2.5	PAYMENT APPLICATIONS .....	31
3.11.4.1	<i>One Product Specified</i> .....	21			
3.11.4.2	<i>Two or More Products Specified</i> .....	22			

4.2.6 REJECTION OF WORK .....	31	4.5.8.1 <i>Trenches or Excavations Less Than Four Feet Below the Surface</i> .....	44
4.2.7 CHANGE ORDERS .....	31	4.5.8.2 <i>Trenches or Excavations Greater Than Four Feet Below the Surface</i> .....	45
4.2.8 WARRANTIES UPON COMPLETION .....	32	4.5.9 INJURY OR DAMAGE TO PERSON OR PROPERTY .....	45
4.2.9 INTERPRETATION.....	32	ARTICLE 5 .....	46
4.2.10 ADDITIONAL INSTRUCTIONS.....	32	SUBCONTRACTORS.....	46
4.2.10.1 <i>Architect’s Interpretations and Decisions</i> .....	32	5.1 DEFINITIONS .....	46
4.2.10.2 <i>Typical Parts and Sections</i> .....	32	5.1.1 SUBCONTRACTOR .....	46
4.2.10.3 <i>Dimensions</i> .....	32	5.1.2 SUB-SUBCONTRACTOR .....	46
4.3 INSPECTOR OF RECORD .....	33	5.1.3 SPECIALTY CONTRACTORS .....	46
4.3.1 GENERAL .....	33	5.2 AWARD OF SUBCONTRACTS AND OTHER CONTRACTS FOR PORTIONS OF THE WORK.....	46
4.3.2 INSPECTOR’S OF RECORD’S DUTIES .....	33	5.2.1 ASSIGNMENT OR SUBSTITUTION - CONSENT OF OWNER .....	46
4.3.3 INSPECTOR OF RECORD’S AUTHORITY TO REJECT OR STOP WORK.....	33	5.2.2 GROUNDS FOR SUBSTITUTION .....	47
4.3.4 INSPECTOR OF RECORD’S FACILITIES ....	33	5.2.2.1 <i>No Change in Contract</i> .....	47
4.4 RESPONSIBILITY FOR ADDITIONAL CHARGES INCURRED BY THE OWNER FOR PROFESSIONAL SERVICES .....	33	5.2.2.2 <i>Substitution Due to Clerical Error</i> .....	48
4.5 NOTICES OF POTENTIAL CHANGE, CHANGE ORDER REQUESTS, AND CLAIMS.....	34	5.3 SUBCONTRACTUAL RELATIONS. ....	48
4.5.1 NOTICE OF POTENTIAL CHANGE .....	35	5.4 CONTINGENT ASSIGNMENT OF SUBCONTRACTS.....	49
4.5.2 CHANGE ORDERS REQUESTS.....	35	5.5 SUBCONTRACTOR’S RESPONSIBILITIES .....	49
4.5.3 DEFINITION OF CLAIM.....	37	5.5.1 SUPERVISION BY SUBCONTRACTORS ....	49
4.5.4 TIME FOR SUBMITTING CLAIM; WAIVER 38		5.5.2 DISCIPLINE AND ORDER .....	49
4.5.5 CONTENT OF CLAIM .....	38	5.5.3 DEFECTS DISCOVERED .....	49
4.5.5.1 <i>Claim Format; Waiver</i> .....	38	5.5.4 SUBCONTRACTOR INFORMATION.....	50
4.5.5.2 <i>Claims for Additional Money</i> .....	40	5.5.5 TEMPORARY STRUCTURES.....	50
4.5.5.3 <i>Claims for Additional Time</i> .....	40	5.5.6 CHARGES TO SUBCONTRACTOR.....	50
4.5.5.3.1 <i>Notice of Extent of Claim</i> .....	40	5.5.7 FINES IMPOSED .....	50
4.5.5.3.2 <i>Unusual and Uncommon Weather Claims</i> .....	41	5.5.8 PROJECT SIGNS .....	50
4.5.5.4 <i>Subcontractor Requests for Money or Time</i> .....	41	5.5.9 REMEDIES FOR FAILURE TO PERFORM ..	51
4.5.6 PROCEDURES FOR CLAIMS (PUBLIC CONTRACT CODE SECTION 9204).....	42	5.5.10 DISPUTES NOT TO AFFECT WORK .....	51
4.5.6.1 <i>Claims</i> .....	42	5.5.11 APPLICATION FOR PAYMENT .....	51
4.5.6.2 <i>Meet and Confer</i> .....	42	5.5.12 COMPLIANCE WITH PROCEDURES .....	51
4.5.6.3 <i>Government Code Claim</i> .....	43	5.5.13 ON-SITE RECORD KEEPING .....	52
4.5.7 CONTINUING CONTRACT PERFORMANCE 44		5.5.14 NON-EXCLUSIVE OBLIGATIONS.....	52
4.5.8 CLAIMS FOR CONCEALED OR UNKNOWN CONDITIONS.....	44	ARTICLE 6.....	52
		CONSTRUCTION BY OWNER OR BY SEPARATE CONTRACTORS.....	52
		6.1 OWNER’S RIGHT TO PERFORM CONSTRUCTION AND TO AWARD SEPARATE CONTRACTS .....	52

6.1.1 OWNER’S RIGHTS.....52

6.1.2 DESIGNATION AS CONTRACTOR .....52

6.1.3 CONTRACTOR DUTIES .....52

6.1.4 OWNER OBLIGATIONS.....53

6.2 MUTUAL RESPONSIBILITY .....53

6.2.1 DELIVERY AND STORAGE.....53

6.2.2 NOTICE BY CONTRACTOR.....53

6.2.3 COSTS INCURRED .....53

6.2.4 CORRECTION OF DAMAGE.....53

6.3 OWNER’S RIGHT TO CLEAN UP ....54

ARTICLE 7 .....54

CHANGES IN THE WORK .....54

7.1 CHANGES .....54

7.1.1 No CHANGES WITHOUT AUTHORIZATION  
54

7.1.2 AUTHORITY TO ORDER MINOR CHANGES  
55

7.2 CHANGE ORDERS .....55

7.3 CONSTRUCTION CHANGE  
DIRECTIVES (“CCD”) .....55

7.3.1 DEFINITION .....55

7.3.2 USE TO DIRECT CHANGE.....56

7.4 REQUEST FOR INFORMATION  
 (“RFI”) .....56

7.4.1 DEFINITION .....56

7.4.2 SCOPE .....56

7.4.3 RESPONSE TIME .....56

7.4.4 COSTS INCURRED .....57

7.5 REQUEST FOR PROPOSAL (“RFP”) 57

7.5.1 DEFINITION .....57

7.5.2 SCOPE .....57

7.6 CHANGE ORDER REQUEST (“COR”)  
57

7.6.1 DEFINITION .....57

7.6.2 CHANGES IN PRICE .....57

7.6.3 CHANGES IN TIME .....57

7.7 PRICE OF CHANGE ORDERS .....58

7.7.1 SCOPE .....58

7.7.2 DETERMINATION OF COST.....58

7.7.3 FORMAT FOR PROPOSED COST CHANGE 60

7.7.4 DISCOUNTS, REBATES, AND REFUNDS ..62

7.7.5 ACCOUNTING RECORDS .....62

7.7.6 NOTICE REQUIRED .....62

7.7.7 APPLICABILITY TO SUBCONTRACTORS..62

7.8 WAIVER OF RIGHT TO CLAIM MONEY OR  
TIME.....62

ARTICLE 8..... 63

TIME 63

8.1 DEFINITIONS ..... 63

8.1.1 CONTRACT TIME ..... 63

8.1.2 NOTICE TO PROCEED ..... 63

8.1.3 DAYS..... 63

8.2 HOURS OF WORK..... 63

8.2.1 SUFFICIENT FORCES ..... 63

8.2.2 PERFORMANCE DURING WORKING HOURS  
63

8.2.3 LABOR CODE APPLICATION..... 63

8.2.4 COSTS FOR AFTER HOURS INSPECTIONS64

8.2.5 TIME FOR COMMENCEMENT BY  
SUBCONTRACTORS ..... 64

8.3 PROGRESS AND COMPLETION..... 64

8.3.1 TIME OF THE ESSENCE ..... 64

8.3.2 No COMMENCEMENT WITHOUT  
INSURANCE..... 65

8.3.3 EXPEDITIOUS COMPLETION ..... 65

8.4 EXTENSIONS OF TIME -  
LIQUIDATED DAMAGES ..... 65

8.4.1 CONDITIONS ALLOWING FOR EXTENSIONS  
OF TIME TO COMPLETE THE WORK ONLY  
(EXCUSABLE DELAY) ..... 65

8.4.2 COMPENSABLE DELAY (TIME AND  
MONEY)..... 66

8.4.3 NOTICE BY CONTRACTOR REQUIRED;  
PROCEDURES FOR DEMANDING  
ADDITIONAL TIME OR MONEY..... 66

8.4.4 EARLY COMPLETION ..... 66

8.4.5 LIQUIDATED DAMAGES ..... 67

8.5 GOVERNMENT APPROVALS ..... 67

ARTICLE 9..... 67

PAYMENTS AND COMPLETION ..... 67

9.1 CONTRACT SUM..... 67

9.2 COST BREAKDOWN ..... 67

9.2.1 REQUIRED INFORMATION ..... 67

9.2.2 OWNER ACCEPTANCE REQUIRED ..... 68

9.3 APPLICATIONS FOR PAYMENT .... 68

9.3.1 PROCEDURE..... 68

9.3.2 PURCHASE OF MATERIALS AND  
EQUIPMENT ..... 69

9.3.3 WARRANTY OF TITLE ..... 70

9.4 REVIEW OF PROGRESS PAYMENT  
70

9.4.1 OWNER ACCEPTANCE..... 70

9.4.2 OWNER’S REVIEW.....	70	10.2.4 USE OR STORAGE OF HAZARDOUS	
9.5 DECISIONS TO WITHHOLD		MATERIAL .....	80
PAYMENT .....	71	10.2.5 FINGERPRINTING.....	80
9.5.1 REASONS TO WITHHOLD PAYMENT.....	71	10.3 PROTECTION OF WORK AND	
9.5.2 PAYMENT AFTER CURE.....	73	PROPERTY.....	80
9.5.3 OVERPAYMENT AND/OR FAILURE TO		10.3.1 PROTECTION OF WORK.....	80
WITHHOLD .....	73	10.3.2 PROTECTION FOR ELEMENTS .....	81
9.6 PROGRESS PAYMENTS .....	73	10.3.3 SHORING AND STRUCTURAL LOADING	81
9.6.1 PAYMENTS TO CONTRACTOR .....	73	10.3.4 CONFORMANCE WITHIN ESTABLISHED	
9.6.2 PAYMENTS TO SUBCONTRACTORS.....	74	LIMITS .....	81
9.6.3 PERCENTAGE OF COMPLETION OR		10.3.5 SUBCONTRACTOR ENFORCEMENT OF	
PAYMENT INFORMATION.....	74	RULES.....	81
9.6.4 NO OBLIGATION OF OWNER FOR		10.3.6 SITE ACCESS.....	81
SUBCONTRACTOR PAYMENT .....	74	10.3.7 PROTECTION OF MATERIALS.....	82
9.6.5 PAYMENT TO SUPPLIERS .....	74	10.4 EMERGENCIES .....	82
9.6.6 PAYMENT NOT CONSTITUTING APPROVAL		10.4.1 EMERGENCY ACTION.....	82
OR ACCEPTANCE .....	75	10.4.2 ACCIDENT REPORTS .....	82
9.6.7 JOINT CHECKS.....	75	10.5 HAZARDOUS MATERIALS.....	82
9.7 COMPLETION OF THE WORK .....	75	10.5.1 DISCOVERY OF HAZARDOUS MATERIALS	
9.7.1 CLOSE-OUT PROCEDURES.....	75	82	
9.7.2 COSTS OF MULTIPLE INSPECTIONS .....	76	10.5.2 HAZARDOUS MATERIAL WORK	
9.8 PARTIAL OCCUPANCY OR USE.....	76	LIMITATIONS .....	82
9.9 FINAL PROGRESS PAYMENT AND		10.5.3 INDEMNIFICATION BY OWNER FOR	
RELEASE OF RETENTION .....	76	HAZARDOUS MATERIAL NOT CAUSED BY	
9.9.1 FINAL APPLICATION FOR PROGRESS		CONTRACTOR .....	83
PAYMENT .....	76	10.5.4 NATURALLY OCCURRING ASBESTOS .....	83
9.9.2 PROCEDURES FOR APPLICATION FOR FINAL		10.5.4 INDEMNIFICATION BY CONTRACTOR FOR	
PROGRESS PAYMENT .....	76	HAZARDOUS MATERIAL CAUSED BY	
9.9.3 RELEASE OF RETAINAGE.....	77	CONTRACTOR .....	83
9.10 SUBSTITUTION OF SECURITIES....	78	10.5.5 TERMS OF HAZARDOUS MATERIAL	
ARTICLE 10 .....	78	PROVISION .....	84
PROTECTION OF PERSONS AND		10.5.6 ARCHEOLOGICAL MATERIALS.....	84
PROPERTY .....	78	ARTICLE 11 .....	84
10.1 SAFETY PRECAUTIONS AND		INSURANCE AND BONDS.....	84
PROGRAMS.....	78	11.1 CONTRACTOR’S LIABILITY	
10.1.1 CONTRACTOR RESPONSIBILITY .....	78	INSURANCE .....	84
10.1.2 SUBCONTRACTOR RESPONSIBILITY .....	79	11.1.1 LIABILITY INSURANCE REQUIREMENTS	84
10.1.3 COOPERATION .....	79	11.1.2 SUBCONTRACTOR INSURANCE	
10.1.4 ACCIDENT REPORTS .....	79	REQUIREMENTS .....	85
10.1.5 FIRST-AID SUPPLIES AT SITE.....	79	11.1.3 OWNER’S INSURANCE.....	85
10.2 SAFETY OF PERSONS AND		11.1.4 ADDITIONAL INSURED ENDORSEMENT	
PROPERTY .....	79	REQUIREMENTS .....	86
10.2.1 THE CONTRACTOR .....	79	11.1.5 WORKERS’ COMPENSATION INSURANCE	
10.2.2 CONTRACTOR NOTICES .....	80	86	
10.2.3 SAFETY BARRIERS AND SAFEGUARDS ..	80	11.1.6 BUILDER’S RISK/ .....	86

11.1.6.1	COURSE-OF-CONSTRUCTION		13.5.4	TESTING OFF-SITE.....	93
	INSURANCE REQUIREMENTS.....	86	13.5.5	ADDITIONAL TESTING OR INSPECTION.	93
11.1.7	CONSENT OF INSURER FOR PARTIAL		13.5.6	COSTS FOR RETESTING .....	93
	OCCUPANCY OR USE .....	87	13.5.7	COSTS FOR PREMATURE TEST.....	94
11.1.8	FIRE INSURANCE .....	87	13.5.8	TESTS OR INSPECTIONS NOT TO DELAY	
11.1.9	OTHER INSURANCE .....	88		WORK.....	94
11.1.10	PROOF OF CARRIAGE OF INSURANCE		13.6	[INTENTIONALLY LEFT BLANK] .	94
	88		13.7	TRENCH EXCAVATION .....	94
11.1.11	COMPLIANCE .....	88	13.7.1	TRENCHES GREATER THAN FIVE FEET	94
11.2	PERFORMANCE AND PAYMENT		13.7.2	EXCAVATION SAFETY.....	94
	BONDS .....	89	13.7.3	NO TORT LIABILITY OF OWNER.....	94
11.2.1	BOND REQUIREMENTS .....	89	13.7.4	NO EXCAVATION WITHOUT PERMITS..	95
11.2.2	SURETY QUALIFICATION .....	89	13.8	WAGE RATES.....	95
ARTICLE 12	.....	89	13.8.1	WAGE RATES.....	95
UNCOVERING AND CORRECTION OF			13.8.2	HOLIDAY AND OVERTIME PAY .....	95
WORK.....		89	13.8.3	WAGE RATES NOT AFFECTED BY	
12.1	UNCOVERING OF WORK .....	89		SUBCONTRACTS.....	95
12.1.1	UNCOVERING WORK FOR REQUIRED		13.8.4	CHANGE IN PREVAILING WAGE DURING	
	INSPECTIONS .....	89		BID OR CONSTRUCTION .....	95
12.1.2	COSTS FOR INSPECTIONS NOT REQUIRED		13.8.5	FORFEITURE AND PAYMENTS.....	95
	90		13.8.6	MINIMUM WAGE RATES .....	96
12.2	CORRECTION OF WORK;		13.8.7	PER DIEM WAGES.....	96
	WARRANTY.....	90	13.8.8	<b>POSTING OF WAGE RATES</b> .....	96
12.2.1	CORRECTION OF REJECTED WORK .....	90	13.9	<b>RECORD OF WAGES PAID:</b>	
12.2.2	REMOVAL OF NONCONFORMING WORK			INSPECTION.....	96
	90		13.9.1	APPLICATION OF LABOR CODE.....	96
12.2.3	OWNER’S RIGHTS IF CONTRACTOR FAILS		13.10	APPRENTICES.....	98
	TO CORRECT.....	90	13.10.1	APPRENTICE WAGES AND	
12.2.4	COST OF CORRECTING THE WORK.....	91		DEFINITIONS.....	98
12.2.5	WARRANTY CORRECTIONS .....	91	13.10.2	APPRENTICE LABOR POOL.....	99
12.2.6	NO TIME LIMITATION.....	91	13.10.3	JOURNEYMAN/APPRENTICE RATIO;	
12.3	NONCONFORMING WORK .....	91		COMPUTATION OF HOURS.....	99
ARTICLE 13	.....	92	13.10.4	JOURNEYMAN/APPRENTICE RATIO	100
MISCELLANEOUS PROVISIONS.....		92		13.10.4.1 <i>Apprenticeable Craft or Trade</i> ..	100
13.1	GOVERNING LAW .....	92	13.10.5	RATIO EXEMPTION .....	100
13.2	SUCCESSORS AND ASSIGNS.....	92	13.10.6	APPRENTICE FUND .....	101
13.3	WRITTEN NOTICE .....	92	13.10.7	PRIME CONTRACTOR COMPLIANCE	101
13.4	RIGHTS AND REMEDIES .....	92	13.10.8	DECISIONS OF JOINT APPRENTICESHIP	
13.4.1	DUTIES AND OBLIGATIONS CUMULATIVE			COMMITTEE.....	101
	92		13.10.9	NO BIAS .....	101
13.4.2	NO WAIVER .....	92	13.10.10	VIOLATION OF LABOR CODE .....	101
13.5	TESTS AND INSPECTIONS .....	93	13.11	ASSIGNMENT OF ANTITRUST	
13.5.1	COMPLIANCE.....	93		CLAIMS .....	102
13.5.2	INDEPENDENT TESTING LABORATORY	93	13.11.1	APPLICATION.....	102
13.5.3	ADVANCE NOTICE TO INSPECTOR OF		13.11.2	ASSIGNMENT OF CLAIM.....	103
	RECORD .....	93	13.12	AUDIT.....	103

13.13 STORM WATER DISCHARGE PERMIT 103	14.2.5 INCLUSION OF TERMINATION FOR CONVENIENCE ..... 105
ARTICLE 14 .....103	14.3 SUSPENSION OR TERMINATION BY THE OWNER FOR CONVENIENCE 105
TERMINATION OR SUSPENSION OF THE CONTRACT ..... 103	14.3.1 SUSPENSION BY OWNER ..... 105
14.1 TERMINATION BY THE CONTRACTOR FOR CAUSE .....103	14.3.1.1 <i>Adjustments</i> ..... 105
14.2 TERMINATION BY THE OWNER FOR CAUSE.....104	14.3.1.2 <i>Adjustments for Fixed Cost</i> ..... 106
14.2.1 GROUNDS FOR TERMINATION.....104	14.3.2 TERMINATION BY THE OWNER FOR CONVENIENCE ..... 106
14.2.2 NOTIFICATION OF TERMINATION .....104	14.4 NOT A WAIVER ..... 106
14.2.3 PAYMENTS ..... 105	14.5 MUTUAL TERMINATION FOR CONVENIENCE..... 106
14.2.4 WRONGFUL TERMINATION.....105	14.6 EARLY TERMINATION ..... 106

## **ARTICLE 1**

### **GENERAL CONDITIONS**

#### **1.1 BASIC DEFINITIONS**

##### **1.1.1 THE CONTRACT DOCUMENTS**

The “Contract Documents” consist of the Agreement between Owner and Contractor (hereinafter the Agreement), Conditions of the Contract (General, Special, Supplementary and other Conditions), Drawings, Specifications, addenda issued prior to bid, Instructions to Bidders, Notice to Bidders, the Bid Form, Project Labor Agreement (if applicable), Local Business Participation Form, Payment Bond, Performance Bond, required insurance certificates, additional insured endorsement and declarations page, Designation of Subcontractors, Noncollusion Declaration, Roof Project Certification (where applicable), Sufficient Funds Declaration (Labor Code section 2810), the Fingerprinting Notice and Acknowledgment and Independent Contractor Student Contact Form, other documents referred to in the Agreement or required by the Instructions to Bidders to be submitted by Contractor, and Modifications issued after execution of the Agreement. A Modification is a written amendment to the Contract signed by both parties, a Change Order, a Construction Change Directive, or a written order for a minor change in the Work issued by the Owner. The Contract Documents are complementary, and each obligation of the Contractor, Subcontractors, material or equipment suppliers in any one shall be binding as if specified in all.

##### **1.1.2 THE CONTRACT**

The Contract Documents form the Contract. The “Contract” represents the entire and integrated agreement between the parties hereto and supersedes prior negotiations, representations, or agreements, either written or oral. The Contract may be amended or modified only by a written Modification. The Contract Documents shall not be construed to create a contractual relationship of any kind between the Architect and Contractor, between the Owner and any Subcontractor or Sub-subcontractor, or between any persons or entities other than the Owner and the Contractor. The terms of the Contract shall not be waived, altered, modified, supplemented or amended in any manner whatsoever except by written agreement signed by the parties and approved or ratified by the Owner’s governing board.

##### **1.1.3 THE WORK**

The “Work” shall include all labor, materials, services and equipment necessary for the Contractor to fulfill all of its obligations pursuant to the Contract Documents, including but not limited to punch list items and submission of documents. It shall include the initial obligation of any Contractor or Subcontractor, who performs any portion of the Work, to visit the Site of the proposed Work with Owner’s representatives, a continuing obligation after the commencement of the Work to fully acquaint and familiarize itself with the conditions as they exist and the character of the operations to be carried on under the Contract Documents, and make such investigation as it may see fit so that it shall fully understand the facilities, physical conditions,



and restrictions attending the Work under the Contract Documents. Each such Contractor or Subcontractor shall also thoroughly examine and become familiar with the Drawings, Specifications, and associated bid documents. The “Site” refers to the grounds of the Project as defined in the Contract Documents and such adjacent lands as may be directly affected by the performance of the Work.

#### **1.1.4 THE PROJECT**

The “Project” is the total construction of the Work performed in accordance with the Contract Documents, but “Project” may also include construction by the Owner or by separate contractors of improvements related to, but not included in, the Work. The Project shall constitute a “work of improvement” under Civil Code section 8050 and Public Contract Code section 7107.

#### **1.1.5 THE DRAWINGS**

The “Drawings” are graphic and pictorial portions of the Contract Documents prepared for the Project and approved changes thereto, wherever located and whenever issued, showing the design, location, and scope of the Work, generally including plans, elevations, sections, details, schedules, and diagrams as drawn or approved by the Architect.

#### **1.1.6 THE SPECIFICATIONS**

The “Specifications” are that portion of the Contract Documents consisting of the written requirements for material, equipment, construction systems, instructions, quality assurance standards, workmanship, and performance of related services.

#### **1.1.7 THE PROJECT MANUAL**

The “Project Manual” is the volume usually assembled for the Work which may include, without limitation, the bidding requirements, sample forms, Agreement, Conditions of the Contract, and Specifications.

#### **1.1.8 OR**

“Or” shall include “and/or.”

#### **1.1.9 COMPLETION**

Statutory definitions of “Completion” and “Complete” shall apply for those statutory purposes. For all other purposes, including accrual of liquidated damages, Claims, and warranties, “Completion” and “Complete” mean the point in the Work where (1) Contractor has fully and correctly performed all Work in all parts and requirements, including corrective and punch list work, and (2) Owner’s representatives have conducted a final inspection that confirmed this performance. Substantial, or any other form of partial or non-compliant, performance shall not constitute “Completion” or “Complete” under the Contract Documents, except to the extent that substantial completion is required for a milestone deadline.

### 1.1.10 COMPLETION OF THE PROJECT

For purposes of accrual of liquidated damages for delay to the Project, *completion* shall mean the point in the Project where (1) all contractors and Owner have fully and correctly performed all work of the entire Project in all parts and requirements, including corrective and punch list work, and (2) Owner's representatives have conducted a final inspection of the entire Project that confirmed this performance. Substantial, or any other form of partial or non-compliant, performance shall not constitute *completion* or *complete*.

## 1.2 EXECUTION, CORRELATION AND INTENT

### 1.2.1 CORRELATION AND INTENT

1.2.1.1 ***Documents Complementary and Inclusive.*** The Contract Documents are complementary and are intended to include all items required for the proper execution and Completion of the Work. Any item of Work mentioned in the Specifications and not shown on the Drawings, or shown on the Drawings and not mentioned in the Specifications, shall be provided by Contractor as if shown or mentioned in both.

1.2.1.2 ***Coverage of the Drawings and Specifications.*** The Drawings and Specifications generally describe the work to be performed by Contractor. Generally, the Specifications describe work which cannot be readily indicated on the Drawings and indicate types, qualities, and methods of installation of the various materials and equipment required for the Work. It is not intended to mention every item of Work in the Specifications, which can be adequately shown on the Drawings, or to show on the Drawings all items of Work described or required by the Specifications even if they are of such nature that they could have been shown. All materials or labor for Work, which is shown on the Drawings or the Specifications (or is reasonably inferable therefrom as being necessary to Complete the Work), shall be provided by the Contractor whether or not the Work is expressly covered in the Drawings or the Specifications. It is intended that the Work be of sound, quality construction, and the Contractor shall be responsible for the inclusion of adequate amounts to cover installation of all items indicated, described, or implied in the portion of the Work to be performed by Contractor.

1.2.1.3 ***Conflicts.*** Without limiting Contractor's obligation to identify conflicts for resolution by the Owner, in the event of a conflict between provisions of the Contract Documents, it is intended that the more stringent, higher quality, and greater quantity of Work shall apply; except that in the event of a conflict between a Division 01 specification and a provision in a Division 00 Contract Document (such as the agreement, general conditions, notice to bidders, instructions to bidders, bid form, etc.), the Division 00 provision shall control.

1.2.1.4 ***Conformance With Laws.*** Each and every provision of law required by law to be inserted in this Contract shall be deemed to be inserted herein, and the Contract shall be read and enforced as though it were included herein, and if through mistake or otherwise any such

provision is not inserted, or is not correctly inserted, then upon application of either party the Contract shall be amended in writing to make such insertion or correction.

Before commencing any portion of the Work, Contractor shall check and review the Drawings and Specifications for such portion for conformance and compliance with all laws, ordinances, codes, rules and regulations of all governmental authorities and public utilities affecting the construction and operation of the physical plant of the Project, all quasi-governmental and other regulations affecting the construction and operation of the physical plant of the Project, and other special requirements, if any, designated in the Contract Documents. In the event Contractor observes any violation of any law, ordinance, code, rule or regulation, or inconsistency with any such restrictions or special requirements of the Contract Documents, Contractor shall promptly notify Architect and Owner in writing of same and shall ensure that any such violation or inconsistency shall be corrected in the manner provided hereunder prior to the construction of that portion of the Work. Where requirements of the Contract Documents exceed those of the applicable building codes and ordinances, the Contract Documents shall govern. Contractor shall comply with all applicable Federal, State and local laws.

If, as and to the extent that Public Contract Code section 1104 is deemed to apply after the award of the Contract, Contractor shall not be required to assume responsibility for the completeness and accuracy of architectural or engineering plans and specifications, notwithstanding any other provision in the Contract Documents, except to the extent that Contractor discovered or should have discovered and reported any errors and omissions to the Architect and Owner, including but not limited to as the result of any review of the plans and specifications by Contractor required by the Instructions to Bidders or other Contract Documents, whether or not actually performed by Contractor.

1.2.1.5 **Ambiguity.** Before commencing any portion of the Work, Contractor shall carefully examine all Drawings and Specifications and other information given to Contractor as to materials and methods of construction and other Project requirements. Contractor shall immediately notify Architect and Owner in writing of any perceived or alleged error, inconsistency, ambiguity, or lack of detail or explanation in the Drawings and Specifications in the manner provided herein. If the Contractor or its Subcontractors, material or equipment suppliers, or any of their officers, agents, and employees performs, permits, or causes the performance of any Work under the Contract Documents, which it knows or should have known to be in error, inconsistent, or ambiguous, or not sufficiently detailed or explained, Contractor shall bear any and all costs arising therefrom including, without limitation, the cost of correction thereof without increase or adjustment to the Contract Sum or the time for performance. If Contractor performs, permits, or causes the performance of any Work under the Contract Documents prepared by or on behalf of Contractor which is in error, inconsistent or ambiguous, or not sufficiently detailed or explained, Contractor shall bear any and all resulting costs, including, without limitation, the cost of correction, without increase to or adjustment in the Contract Sum or the time for performance. In no case shall any Subcontractor proceed with the Work if uncertain without the Contractor's written direction and/or approval.

1.2.1.6 **Execution.** Execution of the Agreement Between Owner and Contractor by the Contractor is a representation that the Contractor has visited the Site, become familiar with the

local conditions under which the Work is to be performed and has correlated personal observations with the requirements of the Contract Documents.

## 1.2.2 ADDENDA AND DEFERRED APPROVALS

1.2.2.1 *Addenda.* Subsequent addenda issued shall govern over prior addenda only to the extent specified. In accordance with Title 24, California Code of Regulations, addenda shall be approved by the Division of the State Architect (“DSA”).

1.2.2.2 *Deferred Approvals.* The requirements approved by the DSA on any item submitted as a deferred approval in accordance with Title 24, California Code of Regulations, shall take precedence over any previously issued addenda, drawing or specification.

## 1.2.3 SPECIFICATION INTERPRETATION

1.2.3.1 *Titles.* The Specifications are separated into titled sections for convenience only and not to dictate or determine the trade or craft involved. Organization of the Specifications into divisions, sections and articles, and arrangement of Drawings shall not control the Contractor in dividing the Work among Subcontractors or in establishing the extent of work to be performed by any trade.

1.2.3.2 *As Shown, Etc.* Where “as shown,” “as indicated,” “as detailed,” or words of similar import are used, reference is made to the Drawings accompanying the Specifications unless otherwise stated. Where “as directed,” “as required,” “as permitted,” “as authorized,” “as accepted,” “as selected,” or words of similar import are used, the direction, requirement, permission, authorization, approval, acceptance, or selection by Architect is intended unless otherwise stated.

1.2.3.3 *Provide.* “Provide” means “provided complete in place,” that is, furnished, installed, tested, and ready for operation and use.

1.2.3.4 *General Conditions.* The General Conditions and any supplementary general conditions are a part of each and every section of the Specifications.

1.2.3.5 *Abbreviations.* In the interest of brevity, the Specifications are written in an abbreviated form and may not include complete sentences. Omission of words or phrases such as “Contractor shall,” “shall be,” etc., are intentional. Nevertheless, the requirements of the Specifications are mandatory. Omitted words or phrases shall be supplied by inference in the same manner as they are when a “note” occurs on the Drawings.

1.2.3.6 *Plural.* Words in the singular shall include the plural whenever applicable or the context so indicates.

1.2.3.7 *Metric.* The Specifications may indicate metric units of measurement as a supplement to U.S. customary units. When indicated thus: 1” (25 mm), the U. S. customary unit is specific, and the metric unit is nonspecific. When not shown with parentheses, the unit is

specific. The metric units correspond to the “International System of Units” (SI) and generally follow ASTM E 380, “Standard for Metric Practice.”

1.2.3.8 **Standard Specifications.** Any reference to standard specifications of any society, institute, association, or governmental authority is a reference to the organization’s standard specifications, which are in effect as of the date the Notice to Bidders is first published. If applicable specifications are revised prior to completion of any part of the Work, the Contractor may, if acceptable to Owner and Architect, perform such Work in accordance with the revised specifications. The standard specifications, except as modified in the Specifications for the Project, shall have full force and effect as though printed in the Specifications. Architect will furnish, upon request, information as to how copies of the standard specifications referred to may be obtained.

1.2.3.9 **Absence of Modifiers.** In the interest of brevity, the Contract Documents frequently omit modifying words such as “all” and “any” and articles such as “the” and “an,” but the fact that a modifier or an article is absent from one statement and appears in another is not intended to affect the interpretation of either statement.

### 1.3 **OWNERSHIP AND USE OF ARCHITECT’S DRAWINGS, SPECIFICATIONS AND OTHER DOCUMENTS**

The Drawings, Specifications, and other documents prepared on behalf of the Owner are instruments of the services of the Architect and its consultants and are the property of the Owner. The Contractor may retain one contract record set. Neither the Contractor nor any Subcontractor, Sub-subcontractor, or material or equipment supplier shall own or claim a copyright in the Drawings, Specifications, and other documents prepared by the Architect, and unless otherwise indicated the Architect shall be deemed the author of them. All copies of them, except the Contractor’s record set, shall be returned or suitably accounted for to the Owner, upon request upon Completion of the Work. The Drawings, Specifications, and other documents prepared by the Architect, and copies thereof furnished to the Contractor, are for use solely with respect to this Contract. They are not to be used by the Contractor or any Subcontractor, Sub-subcontractor, or material or equipment supplier on other contracts or projects or for additions to this Contract or Project outside the scope of the Work without the specific written consent of the Owner and the Architect. The Contractor, Subcontractors, Sub-subcontractors, and material or equipment suppliers are granted a limited license to use and reproduce applicable portions of the Drawings, Specifications, and other documents prepared by the Architect appropriate to and for use in the execution of their Work under the Contract Documents. Submittal or distribution to meet official regulatory requirements or for other purposes in connection with this Project is not to be construed as publication in derogation of the Owner’s property interest or other reserved right. All copies made under this license shall bear appropriate attribution and the statutory copyright notice, if any, shown on the Drawings, Specifications and other documents prepared by the Architect.

## ARTICLE 2

### OWNER

#### 2.1 DEFINITION

The term “Owner” means the person or entity identified as such in the Agreement and is referred to throughout the Contract Documents as if singular in number. The term “Owner” means the Owner and/or the Owner’s authorized representatives, including but not limited to architects and construction managers. To the extent the Contract Documents indicate that Owner has assigned duties to particular representatives of the Owner (such as the Architect, or any construction manager), Owner reserves the right at all times to reassign such duties to different Owner representatives.

#### 2.2 INFORMATION AND SERVICES REQUIRED OF THE OWNER

##### 2.2.1 INTENTIONALLY LEFT BLANK

##### 2.2.2 SITE SURVEY

When required by the scope of the Work, the Owner will furnish, at its expense, a legal description or a land survey of the Site, giving, as applicable, grades and lines of streets, alleys, pavements, adjoining property, rights-of-way, restrictions, easements, encroachments, zoning, deed restrictions, boundaries, and contours of the Site. Surveys to determine locations of construction, grading, and Site work shall be provided by the Contractor.

##### 2.2.3 SOILS

**2.2.3.1 *Owner Furnished Services.*** When required by the scope of the Project, the Owner will furnish, at its expense, the services of geotechnical engineers or consultants when reasonably required or as required by local or state codes. Such services with reports and appropriate professional recommendations shall include test boring, test pits, soil bearing values, percolation tests, air and water pollution tests, and ground corrosion and resistivity tests, including necessary operations for determining subsoil, air, and water conditions.

**2.2.3.2 *Contractor Reliance.*** Test borings and soils reports for the Project have been made for the Owner to indicate the subsurface materials that might be encountered at particular locations on the Project. The Owner has made these documents available to the Contractor and the Contractor has studied the results of such test borings and information that it has as to the subsurface conditions and Site geology as set forth in the test borings and soils reports. The Owner does not assume any responsibility whatsoever with respect to the sufficiency or accuracy of the borings made, or of the logs of the test borings, or of other investigations, or of the soils reports furnished pursuant hereto, or of the interpretations to be made beyond the location or depth of the borings. There is no warranty or guarantee, either express or implied that the conditions indicated by such investigations, borings, logs, soil reports or other information are representative of those existing throughout the Site of the Project, or any part thereof, or that

unforeseen developments may not occur. At the Owner's request, the Contractor shall make available to the Owner the results of any Site investigation, test borings, analyses, studies or other tests conducted by or in the possession of the Contractor or any of its agents. Nothing herein contained shall be deemed a waiver by the Contractor to pursue any available legal right or remedy it may have at any time against any third party who may have prepared any report and/or test relied upon by the Contractor.

#### 2.2.4 UTILITY SURVEY

When required by the scope of the Project, the Owner will furnish, at its expense, all information regarding known existing utilities on or adjacent to the Site, including location, size, inverts, and depths.

#### 2.2.5 INFORMATION

Upon the request of the Contractor, Owner will make available such existing information regarding utility services and Site features, including existing construction, related to the Project as is available from Owner's records. The Contractor may not rely upon the accuracy of any such information, other than that provided under Sections 2.2.2 and 2.2.4 (except that the Contractor may not rely upon, and must question in writing to the Owner and the Architect, any information which appears incorrect based upon Contractor's Site inspection, knowledge of the Work and Project, and prior experience with similar projects), unless specifically stated in writing that the Contractor may rely upon the designated information.

#### 2.2.6 EXISTING UTILITY LINES; REMOVAL, RELOCATION

**2.2.6.1 *Removal, Relocation.*** Pursuant to Government Code section 4215, the Owner assumes the responsibility for removal, relocation, and protection of utilities located on the Site at the time of commencement of construction under this Contract with respect to any such utility facilities which are not identified in the drawings and specifications made part of the invitation to bid. The Contractor shall not be assessed for liquidated damages for delay in Completion of the Work caused by failure of the Owner to provide for removal or relocation of such utility facilities. Owner shall compensate the Contractor for the costs of locating, repairing damage not due to the failure of the Contractor to exercise reasonable care, removing or relocating such utility facilities, and for equipment necessarily idle during such work.

**2.2.6.2 *Assessment.*** These subparagraphs shall not be construed to preclude assessment against the Contractor for any other delays in Completion of the Work. Nothing in these subparagraphs shall be deemed to require the Owner to indicate the presence of existing service laterals or appurtenances whenever the presence of such utilities on the Site can be inferred from the presence of other visible facilities, such as buildings, or meter junction boxes on or adjacent to the Site.

**2.2.6.3 *Notification.*** If the Contractor, while performing work under this Contract, discovers utility facilities not identified by the Owner in the Contract plans or specifications, Contractor shall immediately notify the Owner and the utility in writing.

**2.2.6.4 *Underground Utility Clearance.*** It shall be Contractor's sole responsibility to timely notify all public and private utilities serving the Site prior to commencing work. The Contractor shall notify and receive clearance from any cooperative agency, such as Underground Service Alert, in accordance with Government Code section 4216, et seq. Contractor shall promptly provide a copy of all such notifications to the Owner.

#### **2.2.7 EASEMENTS**

Owner shall secure and pay for easements for permanent structures or permanent changes in existing facilities, if any, unless otherwise specified in the Contract or Contract Documents.

#### **2.2.8 REASONABLE PROMPTNESS**

Information or services under Owner's control will be furnished by the Owner with reasonable promptness. The Owner shall not be liable for any delays caused by factors beyond the Owner's control including but not limited to DSA's or any other local, State or federal agency's review of bids, change order requests, RFI's or any other documents.

#### **2.2.9 COPIES FURNISHED**

The Contractor will be furnished such copies of Drawings and Project Manuals as are stated in the Contract Documents.

#### **2.2.10 DUTIES CUMULATIVE**

The foregoing are in addition to other duties and responsibilities of the Owner enumerated herein, and especially those in Article 6 (Construction by Owner or by Separate Contractors), Article 9 (Payments and Completion), and Article 11 (Insurance and Bonds).

### **2.3 OWNER'S RIGHT TO STOP THE WORK**

If the Contractor fails to correct Work which is not in accordance with the requirements of the Contract Documents, or persistently fails to carry out Work in accordance with the Contract Documents, the Owner may order the Contractor to stop the Work or any portion thereof, until the Contractor corrects the deficiencies. Contractor shall not be entitled to a time extension for any delays caused by such order. The right of the Owner to stop the Work shall not give rise to a duty on the part of the Owner to exercise this right for the benefit of the Contractor or any other person or entity, except to the extent required by Article 6.

### **2.4 OWNER'S RIGHT TO CARRY OUT THE WORK**

If the Contractor fails or refuses to carry out the Work in accordance with the Contract Documents, Owner may correct such deficiencies by whatever reasonable method the Owner may deem expedient without prejudice to other remedies the Owner may have, including but not limited to having another contractor perform some or all of the Work without terminating the Contract with Contractor. Owner may exercise this right at any time during the Contractor's



Work.

Owner shall first provide written notice to Contractor of Contractor's failure or refusal to perform. The notice will provide the time period within which Contractor must begin correction of the failure or refusal to perform. If the Contractor fails to begin correction within the stated time, or fails to continue correction, the Owner may proceed to correct the deficiencies. In the event the Owner bids the work, Contractor shall not be eligible for the award of the contract. The Contractor may be invoiced the cost to Owner of the work, including compensation for additional professional and internally generated services and expenses made necessary by Contractor's failure or refusal to perform. Owner may withhold that amount from the retention, or progress payments due the Contractor, pursuant to Section 9.5. If retention and payments withheld then or thereafter due the Contractor are not sufficient to cover that amount, the Contractor shall pay the difference to the Owner.

### **ARTICLE 3**

#### **THE CONTRACTOR**

##### **3.1 DEFINITION**

The Contractor is the person or entity identified as such in the Agreement and is referred to throughout the Contract Documents as if singular in number. The term "Contractor" means the Contractor or the Contractor's authorized representative. To the extent that any portion of the Work is provided with the Contractor's own forces, any reference to Subcontractors shall be equally applicable to the Contractor.

##### **3.2 SUPERVISION AND CONSTRUCTION PROCEDURES**

###### **3.2.1 CONTRACTOR**

The Contractor shall supervise and direct the Work using the Contractor's best skill and attention, which shall meet or exceed the standards in the industry. The Contractor shall be solely responsible for and have control over construction means, methods, techniques, sequences, procedures, and coordinating all portions of the Work under the Contract, unless Contract Documents give other specific instructions concerning these matters.

If part of the Project is performed by other contractors that Owner directly retains, Owner shall schedule and coordinate the activities of Contractor with the other contractors. Contractor agrees to accept the Owner's construction schedules, schedule updates, overall sequence and coordination of construction for the Project.

Contractor realizes that work by other contractors or Owner may occur simultaneously with Contractor's Work in any given area. Contractor is responsible for its own sequences that may occur within a given activity or set of activities. Contractor shall not commit or permit any act which will adversely affect the work of any other contractor or Owner. Contractor shall provide

layout of its Work at the request of any other contractor or Owner.

Specific duties of the Contractor shall be in accordance with Title 24 of the California Code of Regulations. Contractor shall fully comply with any and all reporting requirements of Education Code sections 17309 and 81141 in the manner prescribed by Title 24.

### **3.2.2 CONTRACTOR RESPONSIBILITY**

The Contractor shall be responsible to the Owner for acts and omissions of the Contractor's employees, Subcontractors, material and equipment suppliers, and their agents, employees, invitees, and other persons performing portions of the Work under direct or indirect contract with the Contractor or any of its Subcontractors.

### **3.2.3 OBLIGATIONS NOT CHANGED BY OTHERS' ACTIONS**

The Contractor shall not be relieved of obligations to perform the Work in accordance with the Contract Documents by the activities or duties of the Owner's representatives, including but not limited to any construction manager and the Architect, or the Inspector of Record; or by tests, inspections, or approvals required or performed by persons other than the Contractor.

### **3.2.4 CONTRACTOR RESPONSIBILITY FOR READINESS FOR WORK**

The Contractor shall be responsible for inspection of Work already performed under the Contract Documents to determine that such portions are in proper condition to receive subsequent work.

### **3.2.5 PROJECT MEETINGS**

During its Work, Contractor shall attend Owner's Project meetings as scheduled by the Contract Documents, or as otherwise instructed by Owner, to discuss the current status of the Work and Project, and the future progress of the Work and the Project. Contractor shall have five (5) days after receipt of Owner's Project meeting minutes to provide written objections and suggested corrections. Either party may audio record any meeting related to the Contract.

## **3.3 SUPERINTENDENT**

### **3.3.1 FULL TIME SUPERINTENDENT**

The Contractor shall provide a competent superintendent and assistants as necessary, all of whom shall be reasonably proficient in speaking, reading and writing English and, who shall be in attendance at the Project Site during performance of the Work. The superintendent shall have five (5) years of experience on K-12 public school construction projects in California. The superintendent shall represent the Contractor, and communications given to the superintendent shall be as binding as if given to the Contractor.

### **3.3.2 STAFF**

The Contractor and each Subcontractor shall: furnish a competent and adequate staff as necessary for the proper administration, coordination, supervision, and superintendence of its portion of the Work; organize the procurement of all materials and equipment so that the materials and equipment will be available at the time they are needed for the Work; and keep an adequate force of skilled workers on the job to Complete the Work in accordance with all requirements of the Contract Documents.

### **3.3.3 RIGHT TO REMOVE**

Owner shall have the right, but not the obligation, to require the removal from the Project of any superintendent, staff member, agent, or employee of any Contractor, Subcontractor, material or equipment supplier, etc., for cause.

## **3.4 LABOR AND MATERIALS**

### **3.4.1 CONTRACTOR TO PROVIDE**

Unless otherwise provided in the Contract Documents, the Contractor shall provide and pay for labor, material, equipment, tools, construction equipment and machinery, water, heat, utilities, transportation, and other facilities and services necessary for proper execution and Completion of the Work whether temporary or permanent, and such facilities, labor, equipment, material, and services are included in the Work. Owner shall not be liable for, and Contractor shall bear the burden of, any post-bid escalation in the cost of materials; but Contractor will retain the benefit of any post-bid material cost decreases. Owner shall have no responsibility for security of, or repair or replacement costs of, such facilities, labor, equipment, material, and services provided by Contractor pursuant to this subsection.

### **3.4.2 QUALITY**

Unless otherwise specified, all materials and equipment to be permanently installed in the Project shall be new and shall be of such quality as required to satisfy the standards of the Contract Documents. The Contractor shall, if requested, promptly furnish satisfactory evidence as to kind and quality of all materials and equipment. All labor shall be performed by workers skilled in their respective trades, and the quality of their work shall meet whichever is the higher standard for their work: the standard in the industry or the standard in the Contract Documents.

### **3.4.3 REPLACEMENT**

Any work, materials, or equipment, which does not conform to these standards may be disapproved and rejected by the Owner, in which case, they shall be removed and replaced by the Contractor at no cost to the Owner.

#### **3.4.4 DISCIPLINE**

The Contractor shall enforce strict discipline and good order among the Contractor's employees and other persons carrying out the Contract in accordance with paragraph 5.5.1 including, but not limited to, Subcontractors, and material or equipment suppliers retained for the Project.

#### **3.5 WARRANTY**

For the period of one (1) year after Completion of the Work (see Sections 9.7.1, 12.2.5, and 12.2.6), the Contractor warrants to the Owner that material and equipment furnished under the Contract will be of good quality and new unless otherwise required or permitted by the Contract Documents, that the Work will be free from defects not inherent in the quality required or permitted, and that the Work will conform with the requirements of the Contract Documents. Work not conforming to these requirements, including substitutions not properly approved and authorized, may be considered defective. The Contractor's warranty does not cover damage or defect caused by abuse, modifications not executed by the Contractor, improper or insufficient maintenance, improper operation, or normal wear and tear under normal usage. If required by the Owner, the Contractor shall furnish satisfactory evidence as to the kind and quality of materials and equipment.

#### **3.6 TAXES**

Contractor will pay all applicable Federal, State, and local taxes on all materials, labor, or services furnished by it, and all taxes arising out of its operations under the Contract Documents. Owner is exempt from Federal Excise Tax, and a Certificate of Exemption shall be provided upon request.

#### **3.7 PERMITS, FEES AND NOTICES**

##### **3.7.1 PAYMENT**

The Contractor shall secure and pay for all permits and governmental fees, licenses, and inspections necessary for proper execution and Completion of the Work which are customarily secured after execution of the Contract and are legally required by any authority having jurisdiction over the Project, except those required by the Division of the State Architect (DSA). Owner shall be responsible for all testing and inspection as required by the DSA on-Site or within the distance limitations set forth in paragraph 13.5.2, unless a different mileage range is specified in the Contract Documents.

##### **3.7.2 COMPLIANCE**

The Contractor shall comply with and give notices required by any law, ordinance, rule, regulation, and lawful order of public authorities bearing on performance of the Work.

### 3.7.3 CONTRACT DOCUMENTS

It is not the Contractor's responsibility to ascertain that the Contract Documents are in accordance with any applicable law, statute, ordinance, building codes, rule, or regulation. However, if the Contractor knew, or should have known, or observes that portions of the Contract Document are at variance therewith, the Contractor shall promptly notify the Architect, any construction manager, and Owner in writing, and necessary changes shall be accomplished by appropriate modification.

### 3.7.4 RESPONSIBILITY

If the Contractor performs any work that it knows, or should have known, is contrary to any law, statute, ordinance, building code, rule or regulation, the Contractor shall assume full responsibility for such work, and shall bear the attributable cost of correction and delays to the Work, other contractors' work, and the Project.

## 3.8 ALLOWANCES

### 3.8.1 CONTRACT

The Contractor shall include in the Contract Sum all allowances, including any general contingency allowance, stated in the Contract Documents. Items covered by specific allowances shall be supplied for such amounts and by such persons or entities as the Owner may direct, but the Contractor shall not be required to employ persons or entities against whom the Contractor makes reasonable and timely objection.

### 3.8.2 SCOPE

3.8.2.1 **Prompt Selection.** Materials and equipment under an allowance shall be selected promptly by the Owner to avoid delay to the Work.

3.8.2.2 **Cost.** Allowances shall cover the cost to the Contractor of materials and equipment delivered at the Site and all required taxes, less applicable trade discounts, etc., as delineated in paragraph 7.7.4.

3.8.2.3 **Cost Included in Contract Sum.** Contractor's costs for unloading and handling at the Site, labor, installation costs, overhead, profit, and other expenses contemplated for stated allowance amounts shall be included in the Contract Sum and not in the allowances.

3.8.2.4 **Contract Sum Adjustment.** Whenever Contractor seeks payment from an allowance and the requested costs are approved by Owner as compliant with the Contract Documents (including Sections 3.8.2.2 and 3.8.2.3, above), Owner may elect to pay the approved costs from the allowance, or pay the costs via Change Order. Any such allowance payment shall conform to the requirements of the Agreement and other Contract Documents.

### 3.9 CONTRACTOR'S CONSTRUCTION SCHEDULES

#### 3.9.1 REQUIREMENTS

Before the Contractor's commencement of Work or within two (2) weeks of award of the Contract, whichever is earlier, Contractor shall prepare and submit for the Owner's, and any construction manager's, information the baseline construction schedule for the Work, which shall conform to the Contract Documents' requirements.

Contractor shall submit an updated schedule by the first day of every month, and whenever else requested by the Owner. Each schedule update must include an accurate as-built schedule and the current as-planned schedule, both of which shall conform to the Contract Documents' requirements. Contractor shall submit its daily logs for the prior month with the updated schedule.

The original schedule and all updates shall conform, at a minimum, to industry standards for (a) critical path scheduling and (b) facilitation of Owner's Project management and evaluation of Contractor Claims for additional money or time.

The original schedule and all updates shall not exceed time limits (including milestone deadlines) under the Contract Documents and shall comply with the Contract Documents scheduling requirements and with any scheduling requirements the Owner provides to the Contractor at the beginning of the Work. The original schedule and all updates shall accurately reflect Work performed to date; reasonable dates for future Work; all construction activities (including procurement); the critical path schedule for Completion of the remainder of the Work; the logic, sequencing, and relationship between the construction activities, including each activity's predecessor and successor activities; and the percentage of the Work completed. Contractor shall specifically include in its schedule and updates at least the number of anticipated calendar days of weather delay to the critical path as indicated in the Special Conditions for each month of the year. These days shall be shown in the schedule and updates as independent critical path activities, and the Contractor may elect to include in the schedule and updates a greater number of days.

The construction schedule shall be in the form of either a tabulation, chart, or graph, unless otherwise stated in Division 1 of the Specifications, and shall be in sufficient detail to show the chronological relationship of all activities of the Work including, but not limited to, estimated starting and completion dates of various activities, (including early and late dates and reasonable float for each activity), procurement of materials, the critical path, and scheduling of equipment. Float suppression techniques such as preferential sequencing, special lead/lag logic restraints, extended activity durations, or imposed dates shall be apportioned for the benefit of the Work. Whenever in the Contract Documents Contractor is required to provide a schedule and/or schedule updates, the Contractor shall provide the schedule and updates in electronic format as well as hard copy. Contractor shall be solely responsible for the accuracy, utility and reasonableness of all of its schedules. Owner's acceptance, approval or non-rejection of Contractor's schedules shall not affect Contractor's responsibility for its schedules.

The Contractor and Owner shall use any float on a “first come, first served” basis. The original schedule and updates shall reflect Contractor’s and Owner’s use of float. Float is not for the exclusive use or benefit of either Owner or Contractor, but it is a jointly owned expiring Work resource available to both parties as needed to meet schedule milestones. For the original schedule and updates, Contractor shall use a critical path network format with the critical paths clearly indicated. Contractor shall use an MS Project, Primavera, or an equivalent or better program. Contractor shall include reports that sort and list the activities in order of increasing float and by early and late start dates. Contractor shall endeavor to label ten to thirty percent (10-30%) of the tasks as critical, but shall not label less than five (5%) or more than fifty (50%) as critical. Contractor shall use calendar days.

If any change in Contractor’s method of operations will cause a change in the construction schedule, Contractor shall submit to Owner, Architect, and any construction manager, a revised construction schedule within seven (7) days of the change.

If, in the Owner’s opinion, the Contractor is not prosecuting the Work at a rate sufficient to meet the Work schedule or a contractual milestone, or to Complete the Work within the Contract Time as adjusted by change orders, or if the Contractor’s actual progress falls behind the Work schedule or it is apparent to Owner that Contractor will not meet contractual milestones or Complete the Work within the Contract Time as adjusted by change orders, the Owner may require that the Contractor prepare and submit a recovery plan. Contractor must submit a recovery plan within seven (7) days of a demand for the plan. At a minimum, the recovery plan must include a proposed schedule that shows Completion of the Work by the contractual milestones and within the Contract Time, as adjusted by change orders, or Completion by other dates Owner specifies in the demand for a recovery plan. The recovery plan shall state the corrective actions Contractor will undertake to implement it. The recovery plan shall also list any additional money that Contractor believes it should receive if Owner orders Contractor to fully or partially implement the recovery plan. If the Owner orders Contractor to implement the recovery plan, Contractor shall do so, but the order shall not constitute an admission by Owner that Contractor is entitled to additional money. To recover additional money, Contractor must comply with General Conditions Articles 4.5, 7 and 8.

All schedules Contractor submits shall be certified as true and correct, as follows:

I, \_\_\_\_\_ [*name of declarant*], declare the following:

\_\_\_\_\_ [*Contractor company name*] has contracted with \_\_\_\_\_ [*public entity name*] for the \_\_\_\_\_ Contract (“Contract”). \_\_\_\_\_ [*Contractor company name*] authorized me to prepare schedules for \_\_\_\_\_ [*public entity name*] for this Project, and I prepared the attached schedule. I am the most knowledgeable person at \_\_\_\_\_ [*Contractor company name*] regarding the scheduling of the Work for this Contract.

The attached schedule does not breach the Contract between \_\_\_\_\_ [*Contractor company name*] and \_\_\_\_\_ [*public entity name*] for this Project,

does not violate any applicable law, satisfies all provisions of the Contract applicable to submission of schedules, only contains truthful and accurate as-built and as-planned dates of the Work (including supporting data), and is not a false claim.

The attached schedule is submitted in compliance with all laws applicable to submission of a Claim, including but not limited to California Penal Code section 72 (Fraudulent Claims), Government Code sections 12650 et seq. (False Claims Act; for example, Government Code section 12651(a)(7)), and Business and Professions Code sections 17200 et seq. (Unfair Business Practices Act). I am aware that submission or certification of false claims, or other Claims that violate law or the Contract, may lead to fines, imprisonment, and/or other serious legal consequences for myself and/or \_\_\_\_\_ [*Contractor company name*].

While preparing this declaration and schedule I consulted with others (including attorneys, consultants, or others who work for \_\_\_\_\_ [*Contractor company name*]) when necessary to ensure that the statements were true and correct.

I declare under the penalty of perjury under the laws of the State of California that the foregoing is true and correct. Executed \_\_\_\_\_, 20\_\_, at \_\_\_\_\_, California.

\_\_\_\_\_  
[signature]  
\_\_\_\_\_  
[name of declarant]

### 3.9.2 DSA OVERSIGHT PROCESS

In connection with the DSA Construction Oversight Process which includes inspection cards and review of changes to the DSA-approved construction documents, the Contractor must (a) include specific tasks in its baseline schedule to take into account these procedures since they are critical path issues; and (b) include a reasonable amount of float in the baseline schedule to accommodate the additional time required by these DSA procedures.

### 3.9.3 FAILURE TO MEET REQUIREMENTS

Failure of the Contractor to provide proper schedules may, at the sole discretion of Owner, constitute either grounds to withhold, in whole or in part, progress payments to the Contractor, or a breach of contract allowing Owner to terminate the Contract.

### 3.10 DOCUMENTS AND SAMPLES AT THE SITE

The Contractor shall maintain at the Site for the Owner one applicable copy of Titles 19 and 24 and record copy of the Drawings, Specifications, Addenda, Change Orders, and other Modifications, in good order and marked currently to record changes and selections made during



construction. In addition, the Contractor shall maintain at the Site approved Shop Drawings, Product Data, Samples, and similar required submittals. These documents shall be available to the Owner and shall be delivered to the Owner, or the Architect for delivery to the Owner, upon Completion of the Work.

### 3.11 SHOP DRAWINGS, PRODUCT DATA, AND SAMPLES

#### 3.11.1 SUBMITTALS DEFINED

3.11.1.1 **Shop Drawings.** The term “shop drawings” as used herein means drawings, diagrams, schedules, and other data, which are prepared by Contractor, Subcontractors, manufacturers, suppliers, or distributors illustrating some portion of the Work, and includes: illustrations; fabrication, erection, layout and setting drawings; manufacturer’s standard drawings; schedules; descriptive literature, instructions, catalogs, and brochures; performance and test data including charts; wiring and control diagrams; and all other drawings and descriptive data pertaining to materials, equipment, piping, duct and conduit systems, and methods of construction as may be required to show that the materials, equipment, or systems and their position conform to the requirements of the Contract Documents. The Contractor shall obtain and submit with the shop drawings all seismic and other calculations and all product data from equipment manufacturers. “Product data” as used herein are illustrations, standard schedules, performance charts, instructions, brochures, diagrams, and other information furnished by the Contractor to illustrate a material, product, or system for some portion of the Work. As used herein, the term “manufactured” applies to standard units usually mass-produced, and “fabricated” means items specifically assembled or made out of selected materials to meet individual design requirements. Shop drawings shall: establish the actual detail of all manufactured or fabricated items, indicate proper relation to adjoining work, amplify design details of mechanical and electrical systems and equipment in proper relation to physical spaces in the structure, and incorporate minor changes of design or construction to suit actual conditions.

3.11.1.2 **Samples.** The term “samples” as used herein are physical examples furnished by Contractor to illustrate materials, equipment, or quality and includes natural materials, fabricated items, equipment, devices, appliances, or parts thereof as called for in the Specifications, and any other samples as may be required by the Owner to determine whether the kind, quality, construction, finish, color, and other characteristics of the materials, etc., proposed by the Contractor conform to the required characteristics of the various parts of the Work. All Work shall be in accordance with the approved samples.

3.11.1.3 **Contractor’s Responsibility.** Contractor shall obtain and shall submit to Architect all required shop drawings and samples in accordance with Contractor’s “Schedule for Submission of Shop Drawings and Samples” provisions in Division 1 of the Specifications and in accordance with the Contractor’s original and updated schedules, and with such promptness as to cause no delay in its own Work or in that of any other contractor, Owner or subcontractor but in no event later than ninety (90) days after the execution of the Agreement. Contractor may be assessed \$100 a day for each day it is late in submitting a shop drawing or sample. No

extensions of time will be granted to Contractor or any Subcontractor because of its failure to have shop drawings and samples submitted in accordance with the Schedule. Each Subcontractor shall submit all shop drawings, samples, and manufacturer's descriptive data for the review of the Owner, the Contractor, and the Architect through the Contractor. By submitting shop drawings, product data, and samples, the Contractor or submitting party (if other than Contractor) represents that it has determined and verified all materials, field measurements, field conditions, catalog numbers, related field construction criteria, and other relevant data in connection with each such submission, and that it has checked, verified, and coordinated the information contained within such submittals with the requirements of the Work and of the Contract Documents. At the time of submission, any deviation in the shop drawings, product data, or samples from the requirements of the Contract Documents shall be narratively described in a transmittal accompanying the submittal. However, submittals shall not be used as a means of requesting a substitution, the procedure for which is defined in paragraph 3.11.4, "Substitutions." Review by Owner and Architect shall not relieve the Contractor or any Subcontractor from its responsibility in preparing and submitting proper shop drawings in accordance with the Contract Documents. Contractor shall stamp, sign, and date each submittal indicating its representation that the submittal meets all of the requirements of the Contract Documents. Any submission, which in Owner's or Architect's opinion is incomplete, contains numerous errors, or has been checked only superficially by Contractor will be returned unreviewed for resubmission by the Contractor.

3.11.1.4 ***Extent of Review.*** In reviewing shop drawings, the Owner will not verify dimensions and field conditions. The Architect will review and approve shop drawings, product data, and samples for aesthetics and for conformance with the design concept of the Work and the information given in the Contract Documents. The Architect's review shall neither be construed as a complete check nor relieve the Contractor, Subcontractor, manufacturer, fabricator, or supplier from responsibility for any deficiency that may exist or from any departures or deviations from the requirements of the Contract Documents unless the Contractor has, in writing, called the Architect's attention to the deviations at the time of submission and the Architect has given specific written approval. The Architect's review shall not relieve the Contractor or Subcontractors from responsibility for errors of any sort in shop drawings or schedules, for proper fitting of the Work, or from the necessity of furnishing any Work required by the Contract Documents, which may not be indicated on shop drawings when reviewed. Contractor and Subcontractors shall be solely responsible for determining any quantities, whether or not shown on the shop drawings.

### 3.11.2 **DRAWING SUBMISSION PROCEDURE**

3.11.2.1 ***Transmittal Letter and Other Requirements.*** All shop drawings must be properly identified with the name of the Contract and Contractor's name and dated, and each lot submitted must be accompanied by a letter of transmittal referring to the name of the Contract and Contractor and to the Specification section number for identification of each item clearly stating in narrative form, as well as "clouding" on the submissions, all qualifications, departures, or deviations from the Contract Documents, if any. Shop drawings, for each section of the Work, shall be numbered consecutively, and the numbering system shall be retained throughout all revisions. All Subcontractor submissions shall be made through the Contractor. Each

drawing shall have a clear space for the stamps of Architect and Contractor. Only shop drawings required to be submitted by the Contract Documents shall be reviewed.

3.11.2.2 **Copies Required.** Each submittal shall include one (1) legible, reproducible sepia and five (5) legible prints of each drawing, including fabrication, erection, layout and setting drawings, and such other drawings as required under the various sections of the Specifications until final acceptance thereof is obtained. Subcontractor shall submit copies, in an amount as requested by the Contractor, of: manufacturers' descriptive data for materials, equipment, and fixtures, including catalog sheets showing dimensions, performance, characteristics, and capacities; wiring diagrams and controls; schedules; all seismic calculations and other calculations; and other pertinent information as required.

3.11.2.3 **Corrections.** The Contractor shall make any corrections required by Architect and shall resubmit as required by Architect the required number of corrected copies of shop drawings or new samples until approved. Contractor shall direct specific attention in writing or on resubmitted shop drawings to revisions other than the corrections required by the Architect on previous submissions. Professional services required for more than one (1) re-review of required submittals of shop drawings, product data, or samples are subject to charge to the Contractor pursuant to paragraph 4.4.

3.11.2.4 **Approval Prior to Commencement of Work.** No portion of the Work requiring a shop drawing or sample submission shall be commenced until the submission has been reviewed by Owner and approved by Architect unless specifically directed in writing by the Owner. All such portions of the Work shall be in accordance with approved shop drawings and samples.

### 3.11.3 SAMPLE SUBMISSIONS PROCEDURE

3.11.3.1 **Samples Required.** In case a considerable range of color, graining, texture, or other characteristics may be anticipated in finished products, a sufficient number of samples of the specified materials shall be furnished by the Contractor to indicate the full range of characteristics, which will be present in the finished products; and products delivered or erected without submittal and approval of full range samples shall be subject to rejection. Except for range samples, and unless otherwise called for in the various sections of the Specifications, samples shall be submitted in duplicate. All samples shall be marked, tagged, or otherwise properly identified with the name of the submitting party, the name of the Contract, the purpose for which the samples are submitted, and the date and shall be accompanied by a letter of transmittal containing similar information, together with the Specification section number for identification of each item. Each tag or sticker shall have clear space for the review stamps of Contractor and Architect.

3.11.3.2 **Labels and Instructions.** Samples of materials, which are generally furnished in containers bearing the manufacturers' descriptive labels and printed application instructions, shall, if not submitted in standard containers, be supplied with such labels and application instructions.

3.11.3.3 **Architect's Review.** The Architect will review and, if appropriate, approve submissions and will return them to the Contractor with the Architect's stamp and signature applied thereto, indicating the appropriate action in compliance with the Architect's standard procedures.

3.11.3.4 **Record Drawings and Annotated Specifications.** The Contractor will prepare and maintain on a current basis an accurate and complete set of Record Drawings showing clearly all changes, revisions, and substitutions during construction, including, without limitation, field changes and the final location of all mechanical equipment, utility lines, ducts, outlets, structural members, walls, partitions, and other significant features, and Annotated Specifications showing clearly all changes, revisions, and substitutions during construction. A copy of such Record Drawings and Annotated Specifications will be delivered to Owner in accordance with the schedule prepared by Contractor. In the event of a specification that allows Contractor to elect one of several brands, makes, or types of material or equipment, the annotations shall show which of the allowable items the Contractor has furnished. The Contractor will update the Record Drawings and Annotated Specifications as often as necessary to keep them current but no less often than weekly. The Record Drawings and Annotated Specifications shall be kept at the Site and available for inspection by the Owner, Inspector of Record and the Architect. On Completion of the Contractor's Work and prior to Application for Final Progress Payment, the Contractor will provide one complete set of Record Drawings and Annotated Specifications to the Owner, certifying them to be a complete and accurate reflection of the actual construction conditions of the Work.

3.11.3.5 **Equipment Manuals.** Contractor shall obtain and furnish to the Owner three (3) complete sets of manuals containing the manufacturers' instructions for maintenance and operation of each item of equipment and apparatus furnished under the Contract Documents and any additional data specifically requested under the various sections of the Specifications for each division of the Work. The manuals shall be arranged in proper order, indexed, and placed in three-ring binders. At the Completion of its Work, the Contractor shall certify, by endorsement thereon, that each of the manuals is complete, accurate, and covers all of its Work. Prior to submittal of Contractor's Application for Final Progress Payment, and as a further condition to its approval by the Architect, each Subcontractor shall deliver the manuals, arranged in proper order, indexed, endorsed, and placed in three-ring binders, to the Contractor, who shall assemble these manuals for all divisions of the Work, review them for completeness, and submit them to the Owner through the Architect.

3.11.3.6 **Owner's Property.** All shop drawings and samples submitted shall become the Owner's property.

#### 3.11.4 SUBSTITUTIONS

3.11.4.1 **One Product Specified.** Unless the Specifications state that no substitution is permitted, whenever in the Contract Documents any specific article, device, equipment, product, material, fixture, patented process, form, method, or type of construction is indicated or specified by name, make, trade name, or catalog number, with or without the words "or equal," such specification shall be deemed to be used for the purpose of facilitating description of material,

process, or article desired and shall be deemed to be followed by the words “or equal.” Contractor may, unless otherwise stated, offer any material, process, or article, which shall be substantially equal or better in every respect to that so indicated or specified and will completely accomplish the purpose of the Contract Documents.

3.11.4.2 ***Two or More Products Specified.*** When two or more acceptable products are specified for an item of the Work, the choice will be up to the Contractor. Contractor shall utilize the same product throughout the Project. If a timely substitution request as set forth in Section 3.11.4.3 is not provided and an “or equal” substitution is requested, the Owner may consider the substitution if the product specified is no longer commercially available. If the Owner allows the substitution to be proposed pursuant to such an untimely request, the Contractor will be responsible for the professional fees incurred by the Architect or Architect’s consultants in reviewing the proposed substitution which fees may be withheld from progress payments and/or retention.

3.11.4.3 ***Substitution Request Form.*** Requests for substitutions of products, materials, or processes other than those specified must be made on the Substitution Request form available from the Owner. Any Requests submitted after the deadline specified in the Instructions to Bidders will not be considered, except as noted in paragraph 3.11.4.2. A Substitution Request must be accompanied by evidence as to whether or not the proposed substitution: is equal in quality and serviceability to the specified item; will entail no changes in detail and construction of related work; will be acceptable in consideration of the required design and artistic effect; will provide no cost disadvantage to Owner; and will require no excessive or more expensive maintenance, including adequacy and availability of replacement parts. The burden of proof of these facts shall be upon the Contractor. The Contractor shall furnish with its request sufficient information to determine whether the proposed substitution is equivalent including but not limited to all drawings, specifications, samples, performance data, calculations, and other information as may be required to assist the Architect and the Owner in determining whether the proposed substitution is acceptable. The final decision shall be the Owner’s. The written approval of the Owner, consistent with the procedure for Change Orders, shall be required for the use of a proposed substitute material. Owner may condition its approval of the substitution upon delivery to Owner of an extended warranty or other assurances of adequate performance of the substitution. All risks of delay due to the Division of the State Architect’s approval, or the approval of any other governmental agency having jurisdiction, of a requested substitution shall be on the requesting party.

3.11.4.4 ***List of Manufacturers and Products Required.*** The Subcontractor shall prepare and submit to the Contractor within thirty (30) days of execution of the Subcontract comprehensive lists, in quadruplicate, of the manufacturers and products proposed for the Project, including information on materials, equipment, and fixtures required by the Contract Documents, as may be required for Contractor’s or Architect’s preliminary approval. Approval of such lists of products shall not be construed as a substitute for the shop drawings, manufacturer’s descriptive data, and samples, which are required by the Contract Documents, but rather as a base from which more detailed submittals shall be developed for the final review of the Contractor and the Architect.

### **3.11.5 DEFERRED APPROVALS**

Deferred approvals shall be submitted and processed pursuant to the requirements of Division 1 of the Specifications. All risks of delay due to the Division of the State Architect's, or any other governmental agency having jurisdiction, approval of a deferred approval shall be on the requesting party.

## **3.12 CUTTING AND PATCHING**

### **3.12.1 SCOPE**

The Contractor shall be responsible for cutting, fitting, or patching required to Complete the Work or to make its parts fit together properly.

### **3.12.2 CONSENT**

The Contractor shall not damage or endanger a portion of the Work or fully or partially completed construction of the Owner or a separate contractor by cutting, patching, or otherwise altering such construction, or by excavation. The Contractor shall not cut or otherwise alter such construction by the Owner or a separate contractor except with written consent of the Owner and of such separate contractor; such consent shall not be unreasonably withheld. The Contractor shall not unreasonably withhold from the Owner or a separate contractor the Contractor's consent to cutting or otherwise altering the Work. All cutting shall be done promptly, and all repairs shall be made as necessary.

### **3.12.3 STRUCTURAL MEMBERS**

New or existing structural members and elements, including reinforcing bars and seismic bracing, shall not be cut, bored, or drilled except by written authority of the Architect. Work done contrary to such authority is at the Contractor's risk, subject to replacement at its own expense and without reimbursement under the Contract. Agency approvals shall be obtained by the Architect, not by the Contractor.

### **3.12.4 SUBSEQUENT REMOVAL**

Permission to patch any areas or items of the Work shall not constitute a waiver of the Owner's or the Architect's right to require complete removal and replacement of the areas or items of the Work if, in the opinion of the Architect or the Owner, the patching does not satisfactorily restore quality and appearance of the Work or does not otherwise conform to the Contract Documents. Any costs caused by defective or ill-timed cutting or patching shall be borne by the person or entity responsible.

### **3.13 CLEANING UP**

#### **3.13.1 CONTRACTOR'S RESPONSIBILITY**

The Contractor shall keep the Site and surrounding area free from accumulation of waste material or rubbish caused by operations under the Contract. The Site shall be maintained in a neat and orderly condition. All crates, cartons, paper, and other flammable waste materials shall be removed from Work areas and properly disposed of at the end of each day. The Contractor shall continuously remove from and about the Site the waste materials, rubbish, tools, construction equipment, machinery, and materials no longer required for the Work.

#### **3.13.2 FAILURE TO CLEANUP**

If the Contractor fails to clean up as provided in the Contract Documents, the Owner may do so, without prior notice to the Contractor and the cost thereof shall be invoiced to the Contractor and withheld from progress payments and/or retention. Each Subcontractor shall have the responsibility for the cleanup of its own Work. If the Subcontractor fails to clean up, the Contractor must do so.

#### **3.13.3 CONSTRUCTION BUILDINGS**

When directed by the Owner or the Architect, Contractor and Subcontractor shall dismantle temporary structures, if any, and remove from the Site all construction and installation equipment, fences, scaffolding, surplus materials, rubbish, and supplies belonging to Contractor or Subcontractor. If the Contractor does not remove the tools, equipment, machinery, and materials within fifteen (15) days after Completion of its Work, then they shall be deemed abandoned, and the Owner can dispose of them for its own benefit in whatever way it deems appropriate. Contractor shall pay for any costs to dispose of the items.

### **3.14 ACCESS TO WORK**

The Contractor shall provide the Owner, the Architect, and the Inspector of Record, access to the Work in preparation and progress wherever located.

### **3.15 ROYALTIES AND PATENTS**

#### **3.15.1 PAYMENT AND INDEMNITY**

The Contractor shall pay all royalties and license fees. The Contractor shall defend suits or claims of infringement of patent rights and shall hold the Owner and the Architect harmless and indemnify them, to the extent not caused by the Owner's active negligence, sole negligence or willful misconduct, from loss on account thereof but shall not be responsible for such defense or loss when a particular design, process, or product of a particular manufacturer is required by the Contract Documents. However, if the Contractor has reason to believe the required design, process, or product is an infringement of a patent, the Contractor shall be responsible for such

loss unless such information is promptly furnished to the Owner and Architect.

### 3.15.2 REVIEW

The review by the Owner or Architect of any method of construction, invention, appliance, process, article, device, or material of any kind shall be for its adequacy for the Work and shall not be an approval for the use by the Contractor in violation of any patent or other rights of any person or entity.

## 3.16 INDEMNIFICATION

### 3.16.1 SCOPE: CONTRACTOR

To the fullest extent permitted by law, the Contractor shall defend, indemnify, and hold harmless the Owner, any construction manager, Architect, Architect's consultants, the Inspector of Record, the State of California, and their respective agents, employees, officers, volunteers, Boards of Trustees, members of the Boards of Trustees, and directors ("Indemnitees"), from and against claims, actions, damages, liabilities, losses (including but not limited to injury or death of persons, property damage, and compensation owed to other parties), and expenses (including but not limited to attorneys' fees and costs including fees of consultants) alleged by third parties against Indemnitees arising out of or resulting from the following: Contractor's, its Subcontractors', or its suppliers' performance of the Work, including but not limited to the Contractor's or its Subcontractors' use of the Site; the Contractor's or its Subcontractors' construction of the Work, or failure to construct the Work, or any portion thereof; the use, misuse, erection, maintenance, operation, or failure of any machinery or equipment including, but not limited to, scaffolds, derricks, ladders, hoists, and rigging supports, whether or not such machinery or equipment was furnished, rented, or loaned by any of the Indemnitees; or any act, omission, negligence, or willful misconduct of the Contractor or its Subcontractors or their respective agents, employees, material or equipment suppliers, invitees, or licensees but only to the extent caused in whole or in part by the acts or omissions of the Contractor, its Subcontractors, its suppliers, anyone directly or indirectly employed by any of them, or anyone for whose acts they may be liable, regardless of whether or not such claim, damage, loss, or expense is caused in part by a party indemnified hereunder. Such obligation shall not be construed to negate, abridge, or reduce other rights or obligations of indemnity, which would otherwise exist as to a party, person, or entity described in this paragraph. The obligation to defend, indemnify and hold harmless includes any claims or actions by third parties arising out of or resulting from Labor Code section 2810. Contractor shall have no obligation to defend or indemnify the Indemnitees against claims, actions, damages, liabilities, losses, and expenses caused by the active negligence, sole negligence or willful misconduct of Indemnitees. This indemnification shall apply to all liability, as provided for above, regardless of whether any insurance policies are applicable, and insurance policy limits do not act as a limitation upon the amount of the indemnification to be provided by the Contractor.

### 3.16.2 SCOPE: SUBCONTRACTORS

3.16.2.1 *Indemnity.* The Subcontractors shall defend, indemnify, and hold harmless the



Indemnites from and against claims, actions, damages, liabilities, and losses (including but not limited to injury or death of persons, property damage, and compensation owed to other parties), and expenses (including but not limited to attorneys' fees and costs including fees of consultants) alleged by third parties against Indemnites arising out of or resulting from the following: Subcontractors' performance of the Work, including but not limited to the Subcontractors' use of the Site; the Subcontractors' construction of the Work or failure to construct the Work or any portion thereof; the use, misuse, erection, maintenance, operation, or failure of any machinery or equipment, including, but not limited to, scaffolds, derricks, ladders, hoists, and rigging supports, whether or not such machinery or equipment was furnished, rented, or loaned by any of the Indemnites; or any act, omission, negligence, or willful misconduct of the Subcontractors or their respective agents, employees, material or equipment suppliers, invitees, or licensees but only to the extent caused in whole or in part by the acts or omissions of the Subcontractors, anyone directly or indirectly employed by any of them, or anyone for whose acts they may be liable, regardless of whether or not such claim, damage, loss, or expense is caused in part by a party indemnified hereunder. Such obligation shall not be construed to negate, abridge, or reduce other rights or obligations of indemnity, which would otherwise exist as to a party, person, or entity described in this paragraph. This obligation to defend, indemnify and hold harmless includes any claims or actions by third parties arising out of or resulting from Labor Code section 2810. Subcontractors shall have no obligation to defend or indemnify the Indemnites against claims, actions, damages, liabilities, losses, and expenses caused by the active negligence, sole negligence or willful misconduct of Indemnites. This indemnification shall apply to all liability, as provided for above, regardless of whether any insurance policies are applicable, and insurance policy limits do not act as a limitation upon the amount of the indemnification to be provided by the Subcontractors.

**3.16.2.2 *Joint and Several Liability.*** In the event more than one Subcontractor is connected with an accident or occurrence covered by this indemnification, then all such Subcontractors shall be jointly and severally responsible to each of the Indemnites for indemnification, and the ultimate responsibility among such indemnifying Subcontractors for the loss and expense of any such indemnification shall be resolved without jeopardy to any Indemnitee. The provisions of the indemnity provided for herein shall not be construed to indemnify any Indemnitee for its own negligence if not permitted by law or to eliminate or reduce any other indemnification or right which any Indemnitee has by law or equity.

### **3.16.3 NO LIMITATION**

The Contractor's and the Subcontractor's obligation to indemnify and defend the Indemnites hereunder shall include, without limitation, any and all claims, damages, and costs: for injury to persons and property (including loss of use), and sickness, disease or death of any person; for breach of any warranty, express or implied; for failure of the Contractor or the Subcontractor to comply with any applicable governmental law, rule, regulation, or other requirement; and for products installed in or used in connection with the Work.

### **3.17 OWNER AS INTENDED BENEFICIARY**

The Owner is an intended beneficiary of any architectural or engineering work secured by, or

performed by, the Contractor to fulfill its obligations under the Contract. Contractor shall state in its contracts with architectural or engineering consultants that their work is for the intended benefit of the Owner.

### **3.18 NOTICE OF EXCUSE FOR NONPERFORMANCE**

If Contractor believes that acts or omissions of Owner (including but not limited to Owner caused delay) have prevented Contractor from performing the Work as required by the Contract Documents and Contractor intends to rely on Owner's acts or omissions and Civil Code section 1511(1) as reasons to excuse Contractor's nonperformance or to support, among other things, Contractor's requests for time extensions under Section 4.5, below, Contractor shall provide written notice of the excuse within five (5) days of the Owner's acts or omissions. If Contractor fails to timely submit the written notice, Contractor shall have waived any right to later rely on the acts or omissions as a defense to Contractor's nonperformance or as the basis for a time extension, regardless of the merits of the defense or time extension. Contractor will not have satisfied a condition precedent or exhausted administrative remedies. Contractor acknowledges that these written notices are of critical importance to the Owner's management of the Work and Project and the mitigation of costs and delays to the Work and Project.

### **3.19 RECOVERY OF COSTS, DAMAGES, OR TIME EXTENSIONS FROM OWNER**

Notwithstanding any other provisions of the Contract Documents, Contractor expressly waives its right to recover any special, consequential, or indirect damages from Owner in relation to this Contract or the Project. Contractor may only recover general (also known as direct) damages from Owner to the extent allowed by the Contract Documents.

A Notice of Potential Change, Change Order Request and, if necessary, a Claim (see Sections 4.5, 7.2, and 7.6, below) are the exclusive means for Contractor to preserve its rights to recover any costs, damages, or time extensions related to the Contract or the Project from Owner, including but not limited to alleged breaches of contract based on extra work, delay, wrongful withholding, or wrongful termination. Contractor's failure to comply with the Contract Documents' procedures for a COR, CO, and Claim (including but not limited to Sections 4.5, 7.2, 7.6, and 7.7, below) may completely waive Contractor's rights to recovery any such costs or damages.

### **3.20 USE OF FEDERAL FUNDS**

If federal funds are being used either in whole or in part for this Project (see the Instructions to Bidders), then the Project is subject to, and Contractor must comply with, all applicable federal laws including but not limited to the federal regulations set forth in CFR Title 2, Part 200. Accordingly, Contractor agrees to comply with all such federal requirements, including but not limited to the following:

A. EQUAL EMPLOYMENT OPPORTUNITY. Contractor agrees to comply with and be bound by Title 14, CFR, Section 60-1.4(b), in accordance with Executive Order 11246, "Equal Employment Opportunity" ([30 FR 12319](#), [12935](#), [3 CFR Part, 1964-1965](#) Comp., p. 339), as

amended by Executive Order 11375, “Amending Executive Order 11246 Relating to Equal Employment Opportunity,” and implementing regulations at [41 CFR part 60](#), “Office of Federal Contract Compliance Programs, Equal Employment Opportunity, Department of Labor,” the terms of which are incorporated by reference as though set forth in full herein.

B. DAVIS-BACON ACT. If the Contract Price exceeds \$2,000, Contractor agrees to comply with and be bound by, and assist Owner in ensuring compliance with, the Davis-Bacon Act, as applicable. (40 U.S.C. §§ 3141-3144; 3146-3148 as supplemented by Department of Labor regulations (29 CFR Part 5, “Labor Standards Provisions Applicable to Contracts Covering Federally Financed and Assisted Construction”).) Contractor is required to pay wages to laborers and mechanics at a rate not less than the prevailing wages specified in a wage determination made by the Secretary of Labor. Additionally, Contractor is required to pay wages not less than once a week. Furthermore, pursuant to the Copeland “Anti-Kickback” Act (40 U.S.C. 3145), as supplemented by Department of Labor regulations (29 CFR Part 3, “Contractors and Subcontractors on Public Building or Public Work Financed in Whole or in Part by Loans or Grants from the United States”), Contractor is prohibited from inducing, by any means, any person employed in the construction, completion, or repair of public work, to give up any part of the compensation to which he or she is otherwise entitled.

C. CONTRACT WORK HOURS AND SAFETY STANDARDS ACT. If the Contract Price exceeds \$100,000 that involve the employment of mechanics or laborers, Contractor agrees to comply with and be bound by, and assist Owner in ensuring compliance with, the Contract Work Hours and Safety Standards Act, as applicable. (40 U.S.C. 3702 and 3704, as supplemented by Department of Labor regulations (29 CFR Part 5).) Under 40 U.S.C. 3702 of the Act, each contractor must be required to compute the wages of every mechanic and laborer on the basis of a standard work week of 40 hours. Work in excess of the standard work week is permissible provided that the worker is compensated at a rate of not less than one and a half times the basic rate of pay for all hours worked in excess of 40 hours in the work week. The requirements of 40 U.S.C. 3704 are applicable to construction work and provide that no laborer or mechanic must be required to work in surroundings or under working conditions which are unsanitary, hazardous or dangerous. These requirements do not apply to the purchases of supplies or materials or articles ordinarily available on the open market, or contracts for transportation or transmission of intelligence.

D. RIGHTS TO INVENTIONS MADE UNDER A CONTRACT AGREEMENT. For all contracts that meet the definition of “funding agreement” under 37 CFR § 401.2 (a) and the recipient or subrecipient wishes to enter into a contract with a small business firm or nonprofit organization regarding the substitution of parties, assignment or performance of experimental, developmental, or research work under that “funding agreement,” Contractor agrees to comply with and be bound by, and assist Owner in ensuring compliance with, 37 CFR Part 401, “Rights to Inventions Made by Nonprofit Organizations and Small Business Firms Under Government Grants, Contracts and Cooperative Agreements,” the provisions of which are incorporated herein by this reference, and any implementing regulations issued by the awarding agency, as applicable.

E. CLEAN AIR AND FEDERAL WATER POLLUTION ACT CONTROL. If the Contract Price exceeds \$150,000, Contractor agrees to comply with and be bound by, and assist Owner in

ensuring compliance with all applicable standards, orders or regulations issued pursuant to the Clean Air Act (42 U.S.C. 7401-7671q) and the Federal Water Pollution Control Act as amended (33 U.S.C. 1251-1387). Any violations must be reported to the Federal awarding agency and the Regional Office of the Environmental Protection Agency (EPA).

F. DEBARMENT AND SUSPENSION. Contractor represents and warrants that it is not listed on the government-wide exclusions in the System for Award Management (SAM), and Contractor agrees to comply with and be bound by, and assist Owner in ensuring compliance with, the OMB guidelines at 2 CFR 180 that implement Executive Orders 12549 (3 CFR part 1986 Comp., p. 189) and 12689 (3 CFR part 1989 Comp., p. 235), “Debarment and Suspension.” SAM Exclusions contains the names of parties debarred, suspended, or otherwise excluded by agencies, as well as parties declared ineligible under statutory or regulatory authority other than Executive Order 12549.

G. BYRD ANTI-LOBBYING AMENDMENT. If the Contract Price exceeds \$100,000, Contractor agrees to comply with and be bound by, and assist Owner in ensuring compliance with, the Byrd Anti-Lobbying Amendment (31 U.S.C. § 1352). Contractor shall file the declaration and certification required by 31 U.S.C. § 1352(b).

H. PROCUREMENT OF RECOVERED MATERIALS. Contractor agrees to comply with, and be bound by, and assist Owner in ensuring compliance with, 2 CFR Section 200.323, as applicable.

I. PROHIBITION ON CERTAIN TELECOMMUNICATIONS AND VIDEO SURVEILLANCE SERVICES OR EQUIPMENT. Contractor agrees to comply with, and be bound by, and assist Owner in ensuring compliance with, 2 CFR Section 200.216, as applicable.

J. DOMESTIC PREFERENCES FOR PROCUREMENT. Contractor agrees to comply with, and be bound by, and assist Owner in ensuring compliance with, 2 CFR Section 200.322, as applicable. 2 CFR Section 200.322 requires Contractor to provide a preference for the purchase, acquisition, or use of goods, products, or materials produced in the United States (including but not limited to iron, aluminum, steel, cement, and other manufactured products), to the greatest extent practicable.

K. CONTRACTING WITH SMALL AND MINORITY BUSINESSES, WOMEN’S BUSINESS ENTERPRISES, AND LABOR SURPLUS AREA FIRMS. Contractor agrees to comply with, and be bound by, and assist Owner in ensuring compliance with, 2 CFR Section 200.321, as applicable. 2 CFR Section 200.321 requires Contractor to take the affirmative steps listed in 2 CFR Section 200.321 paragraphs (b)(1) through (5) to assure that minority businesses, women's business enterprises, and labor surplus area firms are used when possible.

L. SAFETY AND HEALTH STANDARDS. As required by 34 CFR 75.609, Contractor agrees to comply with and be bound by, and assist Owner in ensuring compliance with, the standards under the Federal Occupational Safety and Health Act of 1970 (29 U.S.C.A., Section 651 et seq.) and State and local codes to the extent that they are more stringent.

M. **ENERGY CONSERVATION.** As required by 34 CFR 75.616, Contractor agrees to construct facilities to maximize the efficient use of energy and to comply with and be bound by, and assist OWNER in ensuring compliance with, the following standards of the American Society of Heating, Refrigerating, and Air Conditioning Engineers (ASHRAE) set forth in 34 CFR 75.616. Contractor shall also comply with and be bound by, and assist Owner in ensuring compliance with, the mandatory standards and policies relating to energy efficiency which are contained in the state energy conservation plans issued in compliance with the Energy Policy and Conservation Act (Pub. L 94-163, 89 Stat. 871).

N. If any provision is required by federal law, or by the federal grant program funding such project, to be included in the Contract Documents, such provisions shall be deemed by the parties to have been included.

## **ARTICLE 4**

### **ADMINISTRATION OF THE CONTRACT**

#### **4.1 ARCHITECT**

##### **4.1.1 DEFINITION**

The Architect is the person lawfully licensed to practice architecture or an entity lawfully practicing architecture identified as such in the Agreement and is referred to throughout the Contract Documents as if singular in number. The term “Architect” means the Architect or the Architect’s authorized representative, and shall also refer to all consultants under the Architect’s direction and control.

##### **4.1.2 MODIFICATION**

To the extent the Contract Documents indicate that Owner has assigned duties or responsibilities to the Architect, Owner reserves the right at all times to reassign such duties or responsibilities to different Owner representatives.

##### **4.1.3 TERMINATION**

In the case of the termination of the Architect, the Owner may appoint an architect or another construction professional or may perform such functions with its own licensed professional personnel. The status of the replacement Architect under the Contract Documents shall be that of the former architect.

#### **4.2 ARCHITECT’S ADMINISTRATION OF THE CONTRACT**

##### **4.2.1 STATUS**

The Architect will provide administration of the Contract and may be one of several Owner’s representatives during construction, through release of all retention, and during the one (1) year

period following the commencement of any warranties. The Architect will advise and consult with the Owner. The Architect will have authority to act on behalf of the Owner only to the extent set forth in the Owner/Architect agreement. The Architect will have all responsibilities and power established by law, including California Code of Regulations, Title 24, to the extent set forth in the Owner/Architect agreement.

#### **4.2.2 SITE VISITS**

The Architect will visit the Site at intervals necessary in the judgment of the Architect or as otherwise agreed by the Owner and the Architect in writing to become generally familiar with the progress and quality of the completed Work and to determine in general if the Work is being performed in a manner indicating that the Work, when Completed, will be in accordance with the Contract Documents.

#### **4.2.3 LIMITATIONS OF CONSTRUCTION RESPONSIBILITY**

The Contractor shall not be relieved of obligations to perform the Work in accordance with the Contract Documents either by activities or duties of the Architect in the Architect's administration of the Contract Documents, or by tests, inspections, or approvals required or performed by persons other than the Contractor.

#### **4.2.4 COMMUNICATIONS FACILITATING CONTRACT ADMINISTRATION**

The Owner and the Contractor shall communicate through the Architect, unless there is a construction manager for the Project or the Owner directs otherwise. Communications between Owner and Subcontractors or material or equipment suppliers shall be through the Contractor.

#### **4.2.5 PAYMENT APPLICATIONS**

The Contractor shall submit payment applications to the Architect, unless there is a construction manager for the Project or the Owner directs otherwise.

#### **4.2.6 REJECTION OF WORK**

The Architect, Inspector of Record, any construction manager and others may recommend to the Owner that the Owner reject Work which does not conform to the Contract Documents or that the Owner require additional inspection or testing of the Work in accordance with paragraph 13.5.5, whether or not the Work is fabricated, installed, or completed. However, no recommendation shall create a duty or responsibility to the Contractor, Subcontractors, material and equipment suppliers, their agents or employees, or other persons performing portions of the Work.

#### **4.2.7 CHANGE ORDERS**

The Architect may prepare change orders and construction change directives and may authorize

minor changes in the Work.

#### 4.2.8 WARRANTIES UPON COMPLETION

The Architect in conjunction with the Inspector of Record, or as otherwise directed by Owner, will conduct field reviews of the Work to determine the date of Completion, shall receive and forward to the Owner for the Owner's review and records, written warranties and related documents required by the Contract and assembled by the Contractor. The handling by the Architect of such warranties, maintenance manuals, or similar documents shall not diminish or transfer to the Architect any responsibilities or liabilities required by the Contract Documents of the Contractor or other entities, parties, or persons performing or supplying the Work.

Except as may be otherwise directed by Owner, the Architect will conduct a field review of the Contractor's work pursuant to Section 9.7.1, below, for development of a punch list and one (1) follow-up field review if required. The cost incurred by the Owner for further field reviews or the preparation of further punch lists by the Architect shall be invoiced to the Contractor and withheld from payment and/or retention.

#### 4.2.9 INTERPRETATION

The Architect, Inspector of Record, any construction manager, the Owner or any independent consultant of Owner, as Owner deems appropriate, will interpret and decide matters concerning performance under and requirements of the Contract Documents on written request of the Contractor. The Owner's response to such requests will be made with reasonable promptness, while allowing sufficient time to permit adequate review and evaluation of the request.

#### 4.2.10 ADDITIONAL INSTRUCTIONS

4.2.10.1 *Architect's Interpretations and Decisions.* Interpretations and decisions of the Architect will be consistent with the intent of and reasonably inferable from the Contract Documents and will be in writing or in the form of drawings. When making such interpretations of and decisions regarding the Contract Documents, the Architect will endeavor to secure faithful performance under the Contract Documents by both the Owner and the Contractor and will not show partiality to either. The Work shall be executed in conformity with, and the Contractor shall do no work without, approved drawings, Architect's clarifying instructions, and/or submittals.

4.2.10.2 *Typical Parts and Sections.* Whenever typical parts or sections of the Work are completely detailed on the Drawings, and other parts or sections which are essentially of the same construction are shown in outline only, the complete details shall apply to the Work which is shown in outline.

4.2.10.3 *Dimensions.* Dimensions of Work shall not be determined by scale or rule. Figured dimensions shall be followed at all times. If figured dimensions are lacking on Drawings, Architect shall supply them on request. The Owner's decisions on matters relating to aesthetic effect will be final if consistent with the Contract Documents.

### **4.3 INSPECTOR OF RECORD**

#### **4.3.1 GENERAL**

One or more Project inspectors (“Inspector of Record”) employed by the Owner and approved by the Division of the State Architect will be assigned to the Work in accordance with the requirements of Title 24 of the California Code of Regulations. The Inspector of Record’s duties will be as specifically defined in Title 24.

#### **4.3.2 INSPECTOR OF RECORD’S DUTIES**

All Work shall be under the observation of or with the knowledge of the Inspector of Record. The Inspector of Record shall have free access to any or all parts of the Work at any time. The Contractor shall furnish the Inspector of Record such information as may be necessary to keep the Inspector of Record fully informed regarding progress and manner of work and character of materials. Such observations shall not, in any way, relieve the Contractor from responsibility for full compliance with all terms and conditions of the Contract, or be construed to lessen to any degree the Contractor’s responsibility for providing efficient and capable superintendence. The Inspector of Record is not authorized to make changes in the drawings or specifications nor shall the Inspector of Record’s approval of the Work and methods relieve the Contractor of responsibility for the correction of subsequently discovered defects, or from its obligation to comply with the Contract Documents.

#### **4.3.3 INSPECTOR OF RECORD’S AUTHORITY TO REJECT OR STOP WORK**

The Inspector of Record shall have the authority to reject work that does not comply with the provisions of the Contract Documents. In addition, the Inspector of Record may stop any work which poses a probable risk of harm to persons or property. The Contractor shall instruct its employees, Subcontractors, material and equipment suppliers, etc., accordingly. The absence of any Stop Work order or rejection of any portion of the Work shall not relieve the Contractor from any of its obligations pursuant to the Contract Documents.

#### **4.3.4 INSPECTOR OF RECORD’S FACILITIES**

Within seven (7) days after notice to proceed, the Contractor shall provide the Inspector of Record with temporary facilities.

### **4.4 RESPONSIBILITY FOR ADDITIONAL CHARGES INCURRED BY THE OWNER FOR PROFESSIONAL SERVICES**

If at any time prior to the Completion of the requirements under the Contract Documents, through no fault of its own, the Owner is required to provide or secure additional professional services for any reason by any act or omission of the Contractor, the Contractor shall be invoiced by the Owner for any actual costs incurred for any such additional services, which costs may, among other remedies, be withheld from the progress payments and/or retention. Such invoicing



shall be independent from any other Owner remedies, including but not limited to liquidated damages; *except that* to the extent that such additional services constitute Owner's delay damages under Public Contract Code section 7203, Owner may not recover them or invoice Contractor for them. If payments then or thereafter due to the Contractor are not sufficient to cover such amounts, the Contractor shall pay the difference to the Owner. Additional services shall include, but shall not be limited to, the following:

- A. Services made necessary by the default of the Contractor.
- B. Services made necessary due to the defects or deficiencies in the Work of the Contractor.
- C. Services required by failure of the Contractor to perform according to any provision of the Contract Documents.
- D. Services in connection with evaluating substitutions of products, materials, equipment, Subcontractors proposed by the Contractor, and making subsequent revisions to drawings, specifications, and providing other documentation required (except for the situation where the specified item is no longer manufactured or available).
- E. Services for evaluating and processing Claims submitted by the Contractor in connection with the Work outside the established Change Order process.
- F. Services required by the failure of the Contractor to prosecute the Work in a timely manner in compliance within the specified time for Completion.
- G. Services in conjunction with the testing, adjusting, balancing and start-up of equipment other than the normal amount customarily associated for the type of Work involved.
- H. Services in conjunction with more than one (1) re-review of required submittals of shop drawings, product data, and samples.

#### 4.5 **NOTICES OF POTENTIAL CHANGE, CHANGE ORDER REQUESTS, AND CLAIMS**

If the Contractor identifies the potential for extra work, delay in the critical path schedule, or the need for additional money or time, or if the Contractor requests additional money or time on any grounds (including but not limited to an alleged breach of an implied warranty of the correctness of the plans and specifications [*Souza & McCue Construction Co. v. Superior Court* (1962) 57 Cal.2d 508]), or if the Contractor believes that Owner has failed to pay amounts due or otherwise breached the Contract, or otherwise believes that it is entitled to a modification of the Contract terms and conditions, then Contractor shall follow the procedures in this Section 4.5 and Article 7, otherwise Contractor shall have waived its rights to pursue those issues and any later attempts to recover money or obtain a modification shall be barred. Contractor specifically acknowledges

the Owner's and public's interest in, and need to know of, potential changes and disputes as early as possible so Owner can investigate, mitigate and resolve adverse cost and time impacts, if any. It is Contractor's obligation to know and comply with the requirements of the Contract Documents, including but not limited to Section 4.5 and Articles 7 and 8, and Owner has no obligation to notify Contractor of any failure to comply with those requirements.

#### **4.5.1 NOTICE OF POTENTIAL CHANGE**

Contractor shall submit a written Notice of Potential Change for extra work, critical path delay, or additional money or time. Contractor shall submit written Notices of Potential Change to Owner within five (5) days of the earlier of (a) Contractor becoming aware of the issue creating a potential change, or (ii) the date by which Contractor should have become aware of the issue creating a potential change; unless the issues are, or may soon be, adversely affecting the costs or critical path of the Work, in which case the Contractor must submit the written notice without delay so the Owner may take immediate action to mitigate cost and schedule impacts of the change, if any. The written notice shall explain the nature of the potential change so the Owner may take action to mitigate costs and schedule impacts, if necessary.

When submitting a written Notice of Potential Change based on extra work, Contractor shall not perform the extra work until directed in writing to do so by Owner. When submitting a written Notice of Potential Change for an issue of critical path delay, Contractor shall proactively mitigate the effects of the alleged delay as much as reasonably possible so as to minimize any impact to the schedule, until otherwise directed by Owner. If Contractor intends to rely on Owner's acts or omissions in support of a request for a time extension, then Contractor must also provide the notice set forth in section 3.18, above.

Failure to timely submit a written Notice of Potential Change shall constitute a complete waiver by Contractor of any right to later submit a change order request or pursue a Claim on that issue, or to later pursue any additional money or time extensions in any manner related to that issue, regardless of the merits. Contractor will not have satisfied a condition precedent or exhausted administrative remedies. Contractor acknowledges that these written notices are of critical importance to the Owner's Work and Project management and the mitigation of Work and Project costs and delays.

#### **4.5.2 CHANGE ORDERS REQUESTS**

If, after submitting a written Notice of Potential Change pursuant to Section 4.5.1, Contractor continues to believe that it is entitled to additional money or time (including but not limited to grant of a time extension; payment of money or damages arising from work done by, or on behalf of, the Contractor, payment of which is not otherwise expressly provided for or the claimant is not otherwise entitled to; or an amount the payment of which is disputed by the Owner) based on an issue, then Contractor shall submit a Change Order Request ("COR"; see Section 7.6.1) to Owner within twenty (20) days of the earlier of (i) Contractor becoming aware of the issue creating a potential change, or (ii) the date by which Contractor should have become aware of the issue creating a potential change. A rejection at any time or a lack of a rejection by

Owner of a Notice of Potential Change does not affect the timeline for submitting a COR.

Failure to timely submit a COR related to an issue, or failure to comply with any of the COR requirements in the Contract, shall constitute a complete waiver by Contractor of any right to later submit a COR or Claim on that issue, or to later pursue any additional money or time in any manner related to that issue, regardless of the merits. Contractor will not have satisfied a condition precedent or exhausted administrative remedies.

The COR shall state the grounds for the additional money or time requested and the amount of money or time requested, and Contractor shall include all information and documentation supporting the COR, including but not limited to calculations and analysis that demonstrate that the requested money or time is allowed by the applicable contract provisions and law. For any money or time other than the money and time specifically requested in the COR, Contractor will have completely waived its rights to recover such additional money or time (Contractor will not have satisfied a condition precedent or exhausted administrative remedies). If the COR requests money, then the COR must explain how the requested amounts were calculated. If the COR requests time, then the COR must identify the number of days of time being requested, establish that the days of delay are excusable (see Section 8.4.1), and include some critical path schedule analysis to support the number of days requested. Contractor may not reserve its rights, whether in a COR or other document, to submit a COR at a later time or in a manner other than as required by the Contract Documents. Any inclusion of a reservation of rights in a COR shall be grounds for rejection of the COR.

In the event that costs or delay are continuing to accrue at the time that a COR is required to be submitted, Contractor must still timely submit the COR with all available information and documentation supporting the COR as described above, and Contractor shall identify the costs or delay that are continuing. For continuing costs, the COR must include an estimate of when the extra work is expected to conclude and the total costs that will be incurred by the time that the extra work is expected to conclude. For continuing delay, the COR must include a schedule and delay analysis of when Contractor estimates that the delay will cease, what the final time extension request is estimated to be, and an estimate of the total of delay damages, if any, that will be requested. When the continuing cost or delay ends, within ten (10) days Contractor shall submit an updated COR that states the final dollar amount and/or time extension requested and that includes all required information and documentation. Failure to submit such final COR shall act as a waiver as described above.

Contractor shall certify each COR that it submits, including the initial COR and final COR for a continuing cost or delay, using the form set forth in Section 4.5.5.1, except that every reference to "Claim" shall be changed to "COR." If a COR is submitted without certification, a certification can still be submitted within the timelines set forth in the first paragraph of Section 4.5.2. If the COR is not timely certified, Contractor will have completely waived its rights to any money or time for that issue. Contractor will not have satisfied a condition precedent or exhausted administrative remedies. A certification of an initial COR for a continuing cost or delay shall include a statement that "Any estimates in the attached initial COR for a continuing cost or delay are based on true and correct facts and reasonable assumptions, as explained in the initial COR."

The Owner may accept the entire COR, accept part of the COR and reject the remainder, reject the entire COR, or request additional information. If the Owner does not respond within thirty (30) days of submission of the COR by accepting the entire COR, accepting part of the COR and rejecting the remainder, or requesting additional information, the entire COR shall be deemed rejected as of the thirtieth (30th) day. In the case of continuing costs or delay, the 30-day deadline in the previous sentence shall not apply to the initial COR; it will only apply to the final COR (see above). If the Owner requests additional information within thirty (30) days of submission, then the Contractor shall submit the information within fifteen (15) days of the date of the request and the Owner shall have fifteen (15) days after the receipt of the additional information to accept or reject (in whole or in part) the COR. If the Contractor fails to submit the information within fifteen (15) days, then the COR shall be deemed rejected. If the Owner fails to respond within fifteen (15) days after the submission of additional information, the entire COR shall be deemed rejected as of the fifteenth (15th) day.

#### 4.5.3 DEFINITION OF CLAIM

A “Claim” is a separate demand by the Contractor sent by registered or certified mail, return receipt requested, for (a) a time extension, including, without limitation, a request for relief from damages or penalties for delay assessed by Owner under the Contract Documents; (b) payment by Owner of money or damages arising from work done by, or on behalf of, the Contractor pursuant to the Contract Documents, and payment of which is not otherwise expressly provided for or the claimant is not otherwise entitled to (including but not limited to a claim for damages based on misleading or incomplete plans or specifications); or (c) an amount the payment of which is disputed by the Owner. A Claim includes any claim within the scope of Public Contract Code sections 9204 or 20104 et seq., and any alleged violation of a prompt payment statute. Resubmittal in any manner of a COR which was previously rejected under Section 4.5.2 constitutes a Claim, whether the COR was rejected in whole or in part, and whether the COR was rejected expressly or deemed rejected by Owner inaction. A Claim includes any dispute Contractor may have with the Owner, including one which does not require a Notice of Potential Change or COR under Sections 4.5.1 and 4.5.2, and including any alleged breach of contract or violation of law by the Owner (such as wrongful withholding of a payment by the Owner or wrongful termination by the Owner). A Claim under this Article 4.5 shall also constitute a claim for purposes of the California False Claims Act. In the event of a conflict between a Claims provision in Division 1 of the Specifications and Section 4.5, Section 4.5 shall take precedence.

The Notice of Potential Change and COR procedures above are less formal procedures which precede the more formal Claim. A Notice of Potential Change does not constitute a Claim. A COR does not constitute a Claim; **except that** if insufficient time remains before the Claim deadline (see Article 4.5.4) for Contractor to submit a COR and for Owner to process and reject the COR under Article 4.5.2, then either (1) Contractor may submit a COR which Owner shall treat as a Claim, but only if the COR complies with all requirements in this Article 4.5 and Article 7 for COR’s and Claims, or (2) a COR is not required so long as a Claim complying with this Article 4.5 is timely submitted.

A Claim does not include vouchers, invoices, progress payment applications, or other routine or authorized forms of requests for progress payments on the Contract; however, those documents remain “claims” for purposes of the California False Claims Act. A Claim does not include a Government Code Claim. (“Government Code Claim” means a claim under Government Code sections 900 et seq. and 910 et seq.)

#### **4.5.4 TIME FOR SUBMITTING CLAIM; WAIVER**

Contractor shall submit a Claim to the Owner’s construction manager (or in the absence of a construction manager, to Architect) and Owner within the earlier of (a) fifteen (15) days after Owner’s rejection of a COR in whole or in part, or (b) fifteen (15) days after a COR being deemed rejected, pursuant to Section 4.5.2 above. If the Claim is not based on an issue for which a COR would be required (such as wrongful withholding by the Owner), then Contractor shall submit the Claim within fifteen (15) days after the date on which Contractor knew, or should have known, about the issue on which the Claim is based. If a Claim has not been submitted as of the date that the Contractor Completes the Work and submittal of the Claim was not yet required under the Contract Documents, then the Claim shall be submitted within seven (7) days of Completion of the Work; and such Claim shall not be barred due to lack of a Notice of Potential Change or COR if the deadline for the Notice of Potential Change or COR was after Completion of the Work.

In addition, within seven (7) days of Completion of the Work, Contractor shall submit to Owner, in writing, a list and summary of all Claims for money or time extensions under or arising out of this Contract which were timely filed, which were fully compliant with the Contract’s requirements for Claims, and which the Contractor wishes to pursue in whole or in part. This Claim summary requirement shall not extend the time for submitting a Claim.

Failure to timely submit a Claim or Claim summary, failure to specifically identify a Claim in the Claim summary, or failure to comply with any of the requirements in the Contract for a Claim, including but not limited to this Article 4, will act as a complete waiver of Contractor’s rights to (a) recover money or time on the issues for which a Claim was required, (b) submit a Government Code Claim for the money or time (see Section 4.5.6.4), and (c) initiate any action, proceeding or litigation for the money or time, regardless of the merits; Contractor will not have satisfied a condition precedent or exhausted administrative remedies. Owner does not have an obligation to reject the Claim for a failure to comply with any of the Claim requirements in the Contract, including the lack of certification, and any failure by Owner to reject, or any delay in rejecting, a Claim on that basis does not waive the Owner’s right to reject the Claim on that basis at a later time. In no event may the Contractor reserve its rights to assert a Claim for a time extension or additional money beyond the timelines set forth in this provision unless the Owner agrees in writing to allow the reservation.

#### **4.5.5 CONTENT OF CLAIM**

##### ***4.5.5.1 Claim Format; Waiver***

Every Claim shall be in writing. All money or time extensions sought must be stated and

itemized in the Claim at the time submitted. The responsibility to substantiate Claims shall rest with the Contractor, and the Contractor shall furnish reasonable documentation to support each Claim, including as applicable, that documentation set forth in sections 4.5.5.2 through 4.5.5.4. In addition, the Contractor shall include a certification with each and every Claim at the time of submission, as follows:

I, \_\_\_\_\_ [*name of declarant*], declare the following:

\_\_\_\_\_ [*Contractor company name*] has contracted with \_\_\_\_\_ [*public entity name*] for the \_\_\_\_\_ Contract (“Contract”).  
\_\_\_\_\_ [*Contractor company name*] authorized me to prepare the attached Claim for money and/or time extension for \_\_\_\_\_ [*public entity name*] regarding this Contract (such Claim being dated \_\_\_\_\_, 20\_\_\_\_, and entitled \_\_\_\_\_, and requesting \$ \_\_\_\_\_ and/or \_\_\_\_ additional days), and I prepared the attached Claim. I am the most knowledgeable person at \_\_\_\_\_ [*Contractor company name*] regarding this Claim.

The attached Claim complies with all laws applicable to submission of a Claim, including but not limited to California Penal Code section 72, Government Code sections 12650 et seq. (False Claims Act), and Business and Professions Code sections 17200 et seq. (Unfair Business Practices Act). I am aware that submission or certification of false claims, or other claims that violate law or the Contract, may lead to fines, imprisonment, and/or other serious legal consequences for myself or \_\_\_\_\_ [*Contractor company name*].

The attached Claim does not breach the Contract, is not a false claim, does not violate any applicable law, satisfies all provisions of the Contract applicable to submission of the Claim, only contains truthful and accurate supporting data, and only requests money and/or time extensions that accurately reflect the adjustments to money and time for which I believe that \_\_\_\_\_ [*public entity name*] is responsible under its Contract with \_\_\_\_\_ [*Contractor company name*].

While preparing this declaration and Claim I consulted with others (including attorneys, consultants, or others who work for \_\_\_\_\_ [*Contractor company name*]) when necessary to ensure that the statements were true and correct.

Contractor understands and agrees that any Claim submitted without this certification does not meet the terms of the Contract Documents; that Owner, or Owner’s representatives, may reject the Claim on that basis; and that unless Contractor properly and timely files the Claim with the certification, Contractor cannot further pursue the Claim in any forum and all rights to additional money or time for the issues covered by the Claim are waived due to a condition precedent not having been satisfied.

I declare under the penalty of perjury under the laws of the State of California that the foregoing is true and correct. Executed \_\_\_\_\_, 20\_\_ at \_\_\_\_\_, California.

\_\_\_\_\_ [signature]  
\_\_\_\_\_ [name of declarant]

Contractor's failure to timely submit a certification will constitute a complete waiver of Contractor's rights to (a) recover money or time on the issues for which a Claim was required, (b) submit a Government Code Claim (see Section 4.5.6.3) for the money or time, and (c) initiate any action, proceeding or litigation for the money or time. Contractor will not have satisfied a condition precedent or exhausted administrative remedies.

#### 4.5.5.2 *Claims for Additional Money*

Each Claim for additional money (including but not limited to those described in (b) and (c) of the first paragraph of Section 4.5.3) must include all facts supporting the Claim, including but not limited to all supporting documentation plus a written analysis as to (a) why the claimed cost was incurred, (b) why Contractor could not mitigate its costs, (c) why the claimed cost is the responsibility of the Owner, and (d) why the claimed cost is a reasonable amount. In no event will the Contractor be allowed to reserve its rights, whether in a Claim or other document, to assert a Claim for money at a later time or in a manner other than as required by the Contract Documents. Any inclusion of a reservation of rights in a Claim shall be grounds for rejection of the Claim. Any costs, direct or indirect, not timely asserted in a certified Claim shall be waived. A Claim may not include any costs incurred in preparation of the Claim or in preparation of any underlying COR, including but not limited to costs of delay analysis.

#### 4.5.5.3 *Claims for Additional Time*

##### 4.5.5.3.1 *Notice of Extent of Claim*

If the Contractor wishes to make a Claim for an increase in the Contract Time (including but not limited to Section 4.5.3(a)), the Claim shall include, but not be limited to, all facts supporting the Claim, all documentation of such facts, all information required by the Contract Documents, all information establishing entitlement to a time extension pursuant to Section 8.4.1 below, a current and certified schedule (see Section 3.9.1, above), and a delay analysis explaining (a) the nature of the delay, (b) the Owner's responsibility for the claimed delay, (c) the claimed delay's impact on the critical path, (d) the claimed delay's impact on the date of Completion (including an analysis of any float still remaining and whether the alleged delay in work exceeds such remaining float), and (e) why Contractor could not mitigate the delay impacts. Failure to include an updated and certified schedule, or a delay analysis, in a Claim seeking a time extension will act as a complete waiver of Contractor's rights to (i) recover money or time based on the issues addressed by the Claim, (ii) submit a Government Code Claim for the requested money or time (see Section 4.5.6.4), and (iii) initiate any action, proceeding or litigation for the requested

money or time, regardless of the merits; Contractor will not have satisfied a condition precedent or exhausted administrative remedies.

In no event will the Contractor be allowed to reserve its rights, whether in a Claim or other document, to assert a Claim for a time extension at a later time or in a manner other than as required by the Contract Documents. Any inclusion of a reservation of rights in a Claim shall be grounds for rejection of the Claim. Any time extension not timely asserted in a certified Claim shall be waived.

#### 4.5.5.3.2 *Weather Claims*

If weather is the basis for a Claim for additional time, Contractor's delay analysis (see Section 4.5.5.3.1, above) must also provide data and facts showing that Contractor is entitled to a time extension pursuant to Article 8, including that the weather conditions were unusual and uncommon for the period of time, could not have been reasonably anticipated or mitigated, had an adverse effect on the critical path of the scheduled construction, and meet all other Contract requirements for a time extension (including but not limited to Section 8.4.1, below).

#### 4.5.5.4 *Subcontractor Requests for Money or Time*

A Subcontractor or supplier to Contractor may not submit a request for additional time or money directly to the Owner due to its lack of contractual privity with Owner. If a Subcontractor or supplier submits to Contractor a request for additional money or time based on an alleged breach of the subcontract or supplier contract by Contractor, Contractor may elect to seek money or time from Owner based on that request of the Subcontractor or supplier.

For any such request to Owner by Contractor, Contractor must comply with the requirements and prerequisites in the Contract Documents for requests to the Owner for money or time (including but not limited to Section 4.5 of the General Conditions regarding Notices of Potential Change, Change Order Requests ["CORs"], Claims, and certifications) and with Public Contract Code section 9204(d)(5). Any such COR or Claim by Contractor must include Contractor's certification (see General Conditions §§4.5.2 and 4.5.5.1), a complete copy of the Subcontractor's or supplier's request for money or time (including all documents submitted by the Subcontractor or supplier), and any other necessary supporting documentation. Any such COR or Claim by Contractor must include (a) Contractor's detailed analysis of the merit of Subcontractor's or supplier's request to the Contractor, including (i) analysis of Contractor's alleged breaches of the subcontract or supplier contract that allegedly caused the Subcontractor or supplier to incur damages or delay, and (ii) analysis of all of Contractor's defenses to the request for money or time by the Subcontractor or supplier; and (b) Contractor's detailed analysis of the Owner's liability to Contractor for any money or time that Contractor owes, or may later be determined to owe, to Subcontractor or supplier (including but not limited to how Owner's alleged breaches of the Contract Documents caused Contractor to breach the subcontract or supplier contract). In any such COR or Claim, Contractor may deny that it is liable to the Subcontractor or supplier for some or all of the requested money or time, or it may assert that it is merely submitting the COR or Claim to Owner on behalf of the Subcontractor or supplier; but doing one or the other would not excuse Contractor from complying with the above



requirements for its request to the Owner.

Any failure by Contractor to timely comply with this Section 4.5.5.4 (including a failure to timely submit a Notice of Potential Change, COR, Claim, certifications, or detailed analysis) shall act as a complete waiver of Contractor's rights to (a) recover money or time from Owner based on any money or time that Contractor owes, or may later be determined to owe, to the Subcontractor or supplier, (b) submit a Government Code Claim to Owner for the money or time requested by the Subcontractor or supplier (see Section 4.5.6.3), and (c) initiate any action, proceeding or litigation against Owner for any money or time that Contractor owes, or may later be determined to owe, to the Subcontractor or supplier. Contractor will not have satisfied a condition precedent or exhausted administrative remedies.

#### **4.5.6 PROCEDURES FOR CLAIMS (PUBLIC CONTRACT CODE SECTION 9204)**

Claims are subject to this section 4.5.6 and Public Contract Code section 9204, as well as the separate procedures and substantive provisions of Sections 4.5.1 through 4.5.5 and the rest of the Contract Documents. Claims of \$375,000 or less are also subject to Public Contract Code sections 20104 et seq., but to the extent that one of the procedures in Sections 20104 et seq. conflicts with the procedures in Section 9204, the requirements of Section 9204 shall control.

##### **4.5.6.1 *Claims***

The Owner shall conduct a reasonable review of the Claim and shall respond in writing to any written Claim within 45 days of receipt of the Claim. During that 45-day period, plus any extension, Owner may request, in writing, additional documentation supporting the Claim or relating to defenses to the Claim the Owner may have against the Contractor. Owner shall review any additional documentation Contractor supplies in response to that request within the 45 day, plus any extension, timeline.

After receipt of a Claim, the 45-day period may be extended by Owner and Contractor. The written response shall identify which portion of the Claim is disputed and what portion is undisputed. If Owner needs approval from its governing board to provide the written response, and the governing board does not meet within the 45 days or any extended period of time, then the Owner shall have up to three days after the next publicly noticed meeting of the governing board to provide the written response. Any payment due on an undisputed portion of the Claim shall be processed and made within sixty (60) days after the Owner issues the written response. Owner's failure to respond to a Claim within the above time periods or to otherwise meet the above time requirements shall result in the Claim being deemed rejected in its entirety.

##### **4.5.6.2 *Meet and Confer***

If the Contractor disputes the Owner's written response, or the Owner fails to respond within the time prescribed, the Contractor may so notify the Owner, in writing, either within 15 days of receipt of the Owner's response or within 15 days of the Owner's failure to respond within the time prescribed, respectively, and demand an informal conference to meet and confer for settlement of the issues in dispute. Upon a written demand sent by registered or certified mail

return receipt requested, the Owner shall schedule a meet and confer conference for settlement of the dispute, which shall take place within 30 days of the demand. Upon written agreement of the Owner and Contractor, the conference may take place during regularly scheduled Project meetings. The informal conference is not a mediation since there is no neutral person facilitating communication to assist the parties to reach agreement; therefore, the provisions of Evidence Code sections 1115-1128 shall not apply to any portion of the informal conference (including but not limited to any documents provided or shown, or statements of fact or opinion made, by a party) unless the parties expressly agree in writing to their application. Any offer of compromise at an informal conference shall not be admissible to prove liability, as provided in Evidence Code section 1152, but this statute's prohibition of admissibility shall not apply to other statements before or at the informal conference, or in any document prepared for or exchanged at the informal conference.

If Contractor fails to timely notify the Owner that it wishes to meet and confer pursuant to the previous paragraph, then Contractor will have waived all rights to (a) recover money or time on the issues for which a Claim was required, (b) submit a Government Code Claim (see Section 4.5.6) for such money or time, and (c) initiate any action, proceeding or litigation for such money or time. Contractor will not have satisfied a condition precedent or exhausted administrative remedies.

Within ten (10) business days after the conclusion of the meet and confer conference, the Owner shall give a written statement to the Contractor identifying the portion of the Claim that remains in dispute and the portion that is undisputed. Any payment due on an undisputed portion of the Claim shall be processed and made within sixty (60) days after the Owner issues the written statement. Within ten (10) business days of issuance of Owner's written statement, Contractor shall identify in writing the disputed portion of the Claim that shall be submitted to non-binding mediation (which may consist of any nonbinding process, including but not limited to neutral evaluation or a dispute review board), with the Owner and Contractor sharing the costs equally. The Owner and Contractor shall mutually agree to a mediator within ten (10) business days after the Contractor has identified in writing the disputed portion of the Claim. If they cannot agree upon a mediator, then each shall select a mediator and those two mediators shall select a qualified neutral third party to mediate the disputed portion of the Claim. (Each party shall bear the fees and costs its respective mediator charged in connection with the selection of the neutral mediator). The parties may mutually waive in writing the requirement for mediation. If Contractor fails to timely notify the Owner in writing that it wishes to mediate pursuant to this paragraph, Contractor will have waived all right to further pursue the Claim pursuant to section 4.5.4. The parties shall reasonably cooperate to schedule and attend a mediation as soon as reasonably possible. Owner's failure to respond to the Claim within the above time periods or to otherwise meet the above time requirements shall result in the Claim being deemed rejected in its entirety.

#### 4.5.6.3 *Government Code Claim*

If the Claim or any portion remains in dispute after the mediation and Contractor wishes to pursue it, the Contractor **must** file a timely and proper Government Code Claim. The filing of a Government Code Claim is specifically required in addition to all contractual procedures

described in Sections 4.5 through 4.5.6.2. The above contractual procedures do not act as a substitute for the Government Code Claim process, and the two sets of procedures shall be sequential with the contractual procedures coming first.

Failure to timely file a Government Code Claim shall act as complete waiver of Contractor's rights to (a) recover money or time on the issues for which a Government Code Claim was required, and (b) initiate any action, proceeding or litigation for such money or time. Contractor will not have satisfied a condition precedent or exhausted administrative remedies.

Owner and Contractor shall proceed with the Government Code Claim according to Government Code, Section 900 et seq., and as otherwise permitted by law. For purposes of the applicable Government Code provisions, and as provided in Public Contract Code section 20104.2(e), the running of the time period within which a Contractor must file a Government Code Claim shall be tolled from the time the Contractor submits a written Claim under Article 4.5 until the time that the Claim is denied, in whole or in part, as a result of the meet and confer process in Section 4.5.6.2, including any period of time utilized by the meet and confer process.

#### **4.5.7 CONTINUING CONTRACT PERFORMANCE**

Despite Contractor's submission of, or Owner's rejection of, a Notice of Potential Change, COR, Claim, or Government Code Claim based on alleged breaches of the Contract by Owner, the Contractor shall proceed diligently with performance of the Contract as directed by Owner, and the Owner shall continue to make any undisputed payments in accordance with the Contract. Contractor acknowledges that Completion of the Work is a high priority for both Owner and Contractor as failure to Complete the Work would most likely cause each of them to incur much greater costs and damages than would be incurred if the Work were Completed. If Contractor believes that Owner has breached the Contract and that such breach is preventing or delaying Contractor's performance as directed by Owner, then Contractor must submit notice as required by Section 3.18, above.

#### **4.5.8 CLAIMS FOR CONCEALED OR UNKNOWN CONDITIONS**

##### ***4.5.8.1 Trenches or Excavations Less Than Four Feet Below the Surface***

If Contractor encounters conditions at the Site which are subsurface or otherwise concealed physical conditions, which differ materially from those indicated in the Contract Documents, or unknown physical conditions of an unusual nature, which differ materially from those ordinarily found to exist and generally recognized as inherent in construction activities of the character provided for in the Contract Documents, the Contractor shall give notice to the Owner promptly before conditions are disturbed and in no event later than ten (10) days after first observance of the conditions. If Contractor believes that such conditions differ materially and will cause an increase in the Contractor's cost of, time required for, or performance of any part of the Work, Contractor must comply with the provisions above for Notice of Potential Change, Change Order Request, and Claims (beginning with Section 4.5.1).

#### 4.5.8.2 *Trenches or Excavations Greater Than Four Feet Below the Surface*

Pursuant to Public Contract Code section 7104, when any excavation or trenching extends greater than four feet below the surface:

4.5.8.2.1 The Contractor shall promptly, and before the following conditions are disturbed, notify the public entity, in writing, of any:

(1) Material that the Contractor believes may be material that is hazardous waste, as defined in Section 25117 of the Health and Safety Code, that is required to be removed to a Class I, Class II, or Class III disposal site in accordance with the provisions of existing law.

(2) Subsurface or latent physical conditions at the site differing from those indicated by information about the site made available to bidders prior to the deadline for submitting bids.

(3) Unknown physical conditions at the site of any unusual nature, different materially from those ordinarily encountered and generally recognized as inherent in work of the character provided for in the Contract.

4.5.8.2.2 The public entity shall promptly investigate the conditions, and if it finds that the conditions do materially so differ, or do involve hazardous waste, and cause a decrease or increase in the Contractor's cost of, or the time required for, performance of any part of the Work shall issue a change order under the procedures described in the Contract.

4.5.8.2.3 In the event that a dispute arises between the public entity and the Contractor whether the conditions materially differ, or involve hazardous waste, or cause a decrease or increase in the Contractor's cost of, or time required for, performance of any part of the Work, the Contractor shall not be excused from any deadline for Completion provided by the Contract, but shall proceed with all Work to be performed under the Contract. The Contractor shall retain any and all rights provided either by Contract or by law which pertain to the resolution of disputes and protests between the contracting parties.

#### 4.5.9 **INJURY OR DAMAGE TO PERSON OR PROPERTY**

If either party to the Contract suffers injury or damage to person or property because of an act or omission of the other party, any of the other party's employees or agents, or others for whose acts such party is legally liable, written notice of such injury or damage, whether or not insured, shall be given to the other party within a reasonable time not exceeding ten (10) days after first observance. The notice shall provide sufficient detail to enable the other party to investigate the matter. For a Notice of Potential Change, COR and Claim for additional cost or time related to this injury or damage, Contractor shall follow Section 4.5.

## **ARTICLE 5**

### **SUBCONTRACTORS**

#### **5.1 DEFINITIONS**

##### **5.1.1 SUBCONTRACTOR**

A Subcontractor is a person or entity, who has a contract with the Contractor to perform a portion of the Work at the Site. The term “Subcontractor” is referred to throughout the Contract Documents as if singular in number and means a Subcontractor or an authorized representative of the Subcontractor. The term “Subcontractor” does not include a separate contractor or subcontractors of a separate contractor. To the extent that the term Trade Contractor is utilized in the Contract Documents, it shall have the same meaning as the term “Subcontractor.”

##### **5.1.2 SUB-SUBCONTRACTOR**

A Sub-subcontractor is a person or entity who has a direct or indirect contract with a Subcontractor to perform a portion of the Work at the Site. The term “Sub-subcontractor” is referred to throughout the Contract Documents as if singular in number and means a Sub-subcontractor or an authorized representative of the Sub-subcontractor.

##### **5.1.3 SPECIALTY CONTRACTORS**

If a Subcontractor is designated as a “Specialty Contractor” as defined in section 7058 of the Business and Professions Code, all of the Work outside of that Subcontractor’s specialty shall be performed in compliance with the Subletting and Subcontracting Fair Practices Act, Public Contract Code sections 4100, et seq.

#### **5.2 AWARD OF SUBCONTRACTS AND OTHER CONTRACTS FOR PORTIONS OF THE WORK**

##### **5.2.1 ASSIGNMENT OR SUBSTITUTION - CONSENT OF OWNER**

In accordance with Public Contract Code sections 4107 and 4107.5, no Contractor whose bid is accepted shall, without the written consent of the Owner: substitute any person or entity as a Subcontractor in place of the Subcontractor designated in the original bid; permit any such Subcontract to be assigned or transferred, or allow it to be performed by any person or entity other than the original Subcontractor listed in the original bid; sublet or subcontract any portion of the Work in excess of one-half of one percent (0.5%) of the Contractor’s total bid as to which its original bid did not designate a Subcontractor. Any assignment or substitution made without the prior written consent of the awarding authority shall be void, and the assignees shall acquire no rights in the Contract. Any consent, if given, shall not relieve Contractor or its

Subcontractors from their obligations under the terms of the Contract Documents.

### 5.2.2 GROUNDS FOR SUBSTITUTION

Pursuant to Public Contract Code section 4107 and the procedure set forth therein, no Contractor whose bid is accepted may request to substitute any person or entity as a Subcontractor in place of a Subcontractor listed in the original bid except in the following instances:

- A. When the Subcontractor listed in the bid after having a reasonable opportunity to do so, fails or refuses to execute a written contract for the scope of work specified in the subcontractor's bid and at the price specified in the subcontractor's bid, when that written contract, based upon the general terms, conditions, plans and specifications for the Project involved or the terms of that Subcontractor's written bid, is presented to the Subcontractor by the Contractor;
- B. When the listed Subcontractor becomes insolvent or the subject of an order for relief in bankruptcy;
- C. When the listed Subcontractor fails or refuses to perform his or her Subcontract;
- D. When the listed Subcontractor fails or refuses to meet the bond requirements of the prime contractor set forth in Public Contract Code section 4108.
- E. When the Contractor demonstrates to the awarding authority, or its duly authorized officer, subject to the further provisions of Public Contract Code section 4107.5, that the name of the Subcontractor was listed as the result of inadvertent clerical error;
- F. When the listed Subcontractor is not licensed pursuant to the Contractors License Law; or
- G. When the awarding authority, or its duly authorized officer, determines that the Work being performed by the listed Subcontractor is substantially unsatisfactory and not in substantial accordance with the plans and specifications, or the Subcontractor is substantially delaying or disrupting the progress of the Work.
- H. When the listed Subcontractor is ineligible to work on a public works project pursuant to Section 1777.1 of the Labor Code.
- I. When the awarding authority determines that a listed Subcontractor is not a responsible contractor.

5.2.2.1 **No Change in Contract.** Any substitutions of Subcontractors shall not result in any increase in the Contract Sum or result in the granting of any extension of time for a Milestone Deadline or the Completion of the Work.

**5.2.2.2 Substitution Due to Clerical Error.** The Contractor, as a condition of asserting a claim of inadvertent clerical error in the listing of a Subcontractor, shall, pursuant to Public Contract Code section 4107.5, within two (2) working days after the time of the prime bid opening by the awarding authority, give written notice to the awarding authority and copies of such notice to both the Subcontractor it claims to have listed in error, and the intended Subcontractor who had bid to the Contractor prior to bid opening. Any listed Subcontractor who has been notified by the Contractor in accordance with the provisions of this section as to an inadvertent clerical error, shall be allowed six (6) working days from the time of the prime bid opening within which to submit to the awarding authority and to the Contractor written objection to the Contractor's claim of inadvertent clerical error.

In all other cases, the Contractor must make a request in writing to the awarding authority for the substitution of a subcontractor, giving reasons therefore. The awarding authority shall mail a written notice to the listed Subcontractor giving reasons for the proposed substitution. The listed Subcontractor shall have five (5) working days from the date of such notice within which to file with the awarding authority written objections to the substitution.

Failure to file written objections pursuant to the provisions of this section within the times specified herein shall constitute a complete waiver of objection to the substitution by the listed Subcontractor and, where the ground for substitution is an inadvertent clerical error, an agreement by the listed Subcontractor that an inadvertent clerical error was made.

If written objections are filed, the awarding authority shall give five (5) days notice to the Contractor and to the listed Subcontractor of a hearing by the awarding authority on the Contractor's request for substitution as provided in Public Contract Code section 4107. The determination by the awarding authority shall be final.

### **5.3 SUBCONTRACTUAL RELATIONS**

By appropriate agreement, written where legally required for validity, the Contractor shall require each Subcontractor, to the extent of the Work to be performed by the Subcontractor, to be bound to the Contractor by terms of the Contract Documents, and to assume toward the Contractor all obligations and responsibilities, which the Contractor, by the Contract Documents, assumes toward the Owner. Each subcontract agreement shall preserve and protect the rights of the Owner under the Contract Documents with respect to the Work to be performed by the Subcontractor so that subcontracting thereof will not prejudice such rights, and shall allow to the Subcontractor, unless specifically provided otherwise in the subcontract agreement, the benefit of all rights, remedies, and redress against the Contractor that the Contractor, by the Contract Documents, has against the Owner. Where appropriate, the Contractor shall require each Subcontractor to enter into similar agreements with Sub-subcontractors. The Contractor shall make available to each proposed Subcontractor, prior to the execution of the subcontract agreement, copies of the Contract Documents to which the Subcontractor will be bound. Upon written request of the Subcontractor, the Contractor shall identify to the Subcontractor the terms and conditions of the proposed subcontract agreement, which may be at variance with the Contract Documents. Subcontractors shall similarly make copies of applicable portions of such

documents available to their respective proposed Sub-subcontractors.

#### **5.4 CONTINGENT ASSIGNMENT OF SUBCONTRACTS**

Each subcontract agreement for a portion of the Work is assigned by the Contractor to the Owner provided that:

- A. Assignment is effective only after termination of the Contract with the Contractor by the Owner for cause pursuant to Article 14 and only for those subcontract agreements which the Owner accepts by notifying the Subcontractor in writing; and
- B. Assignment is subject to the prior rights of the surety, if any, obligated under any bond relating to the Contract.

#### **5.5 SUBCONTRACTOR'S RESPONSIBILITIES**

Every Subcontractor is bound to the following provisions, unless specifically noted to the contrary in the Subcontractor's contract subject to the limitations of section 5.3.

##### **5.5.1 SUPERVISION BY SUBCONTRACTORS**

Subcontractors shall efficiently supervise their Work, using their best skill and attention. Each of them shall carefully study and compare all Drawings, Specifications, and other instructions, shall at once report to Contractor any error or omission which any of them may discover, and shall subsequently proceed with the Work in accordance with instructions from the Contractor concerning such error or omission. Each Subcontractor shall be fully responsible for and shall bear the full risk of loss of all of its property.

##### **5.5.2 DISCIPLINE AND ORDER**

Each Subcontractor shall at all times enforce strict discipline and good order among its Subcontractors, material or equipment suppliers, or their agents, employees, and invitees, and shall establish and maintain surveillance over the activities of each of the foregoing to minimize any disturbance, damage, pollution, or unsightly conditions relative to property areas adjacent to or in the vicinity of the Site. The Contractor shall have the right to remove from the Work any employee of a Subcontractor for any reason including, without limitation, incompetence or carelessness.

##### **5.5.3 DEFECTS DISCOVERED**

Should the proper and accurate performance of the Work depend upon the proper and accurate performance of other work not included in its Contract, each Subcontractor shall use all necessary means to discover any defect in such other work and shall allow the Contractor, the Owner and Architect, or other Subcontractors as Contractor elects, a reasonable amount of time to remedy such defects. If the Subcontractor should proceed with its Work, it shall be considered



to have accepted such other work, unless the Subcontractor shall have proceeded pursuant to instructions in writing by the Contractor over its written objection.

#### **5.5.4 SUBCONTRACTOR INFORMATION**

Each Subcontractor shall submit to the Owner, the Contractor, or the Architect, as the case may be, promptly when requested by any of the foregoing, information with respect to the names, responsibilities, and titles of the principal members of its staff, the adequacy of the Subcontractor's equipment and the availability of necessary materials and supplies. Subcontractor shall fully cooperate with Contractor in its periodic review of the adequacy of Subcontractor's supervision, personnel, and equipment, and the availability of necessary materials and supplies and shall promptly comply with the requirements of the Contractor with respect thereto.

#### **5.5.5 TEMPORARY STRUCTURES**

Each Subcontractor shall furnish at its expense its own temporary facilities and storage except those specifically agreed to be furnished to it by the Contractor in the Subcontract Agreement. Subcontractor's material storage rooms and field offices, etc., will be placed in locations designated by the Contractor. When it becomes necessary due to the progress of the Work for the Subcontractor to relocate its field operations, it will do so in an expeditious manner and at no additional cost to Contractor or Owner. The construction of material storage rooms and field offices, etc., will be of fire resistive material only, such as concrete or gypsum block, rated drywall, or sheet metal.

#### **5.5.6 CHARGES TO SUBCONTRACTOR**

Each Subcontractor may be subject to the Contractor's reasonable charges for hoisting, repair to other work caused by the fault or negligence of Subcontractor, removal of Subcontractor's rubbish, and clean-up occasioned by Subcontractor.

#### **5.5.7 FINES IMPOSED**

Subcontractor shall comply with and pay any fines or penalties imposed for violation of any applicable law, ordinance, rule, regulation, Environmental Impact Report mitigation requirement, and lawful order of any public authority, including, without limitation, all OSHA and California OSHA requirements and those of other authorities having jurisdiction of the safety of persons or property.

#### **5.5.8 PROJECT SIGNS**

Each Subcontractor shall not display on or about the Project any sign, trademark, or other advertisement. The Owner will permit a single Project sign, which shall be subject to the Owner's prior and sole discretion and approval, as to all matters including, without limitation, size, location, material, colors, style and size of printing, logos and trademarks (if any), text, and

selection of names to be displayed.

#### **5.5.9 REMEDIES FOR FAILURE TO PERFORM**

Without limitation of any other right or remedy available to Contractor under the Contract Documents or at law, should: the Subcontractor fail to perform its portion of the Work in a skilled and expeditious manner in accordance with the terms of the Contract Documents with sufficient labor, materials, equipment, and facilities; delays the progress of the job or otherwise fail in any of its obligations; or either a receiver is appointed for the Subcontractor or the Subcontractor is declared to be bankrupt or insolvent, and such appointment, bankruptcy, or insolvency proceedings or declaration is not set aside within thirty (30) days, then the Contractor, upon three (3) days notice to the Subcontractor (subject to the requirements of Pub. Contracts Code, § 4107), may provide such labor, materials, or perform such work and recover the cost plus profit and overhead from monies due or to become due thereafter to the Subcontractor. The Contractor may terminate the employment of the Subcontractor, taking possession of its tools, materials, and equipment related to the Work and cause the entire portion of the Subcontractor's Work to be finished either by another Subcontractor or through the Contractor's own forces.

#### **5.5.10 DISPUTES NOT TO AFFECT WORK**

In the event of any dispute as to whether or not any portion of the Work is within the scope of the Work to be performed by a Subcontractor, or any dispute as to whether or not the Subcontractor is entitled to a Change Order for any Work requested of it or entitled to payment, the Subcontractor shall continue to proceed diligently with the performance of the Work. Regardless of the size or nature of the dispute, the Subcontractor shall not under any circumstances cease or delay performance of its portion of the Work during the existence of the dispute. The Contractor shall continue to pay the undisputed amounts called for under the Subcontract Agreement during the existence of the dispute. Any party stopping or delaying the progress of the Work because of a dispute shall be responsible in damages to the Owner, the Architect, and the Contractor for any losses suffered as a result of the delay.

#### **5.5.11 APPLICATION FOR PAYMENT**

Contractor agrees to advise the Subcontractor if any documentation in connection with the Subcontractor's application for payment has not been accepted or is in any way unsatisfactory.

#### **5.5.12 COMPLIANCE WITH PROCEDURES**

Each Subcontractor shall comply with all procedures established by the Contractor for coordination among the Owner, the Owner's consultants, Architect, Contractor, and the various Subcontractors for coordination of the Work with all local municipal authorities, government agencies, utility companies, and any other agencies with jurisdiction over all or any portion of the Work. The Subcontractor shall cooperate fully with all of the foregoing parties and authorities.

### **5.5.13 ON-SITE RECORD KEEPING**

Subcontractor shall comply with all on-Site record keeping systems established by the Contractor and shall, upon the request of the Contractor, provide the Contractor with such information and reports as the Contractor may deem appropriate. Without limitation of the foregoing, the Subcontractor shall assemble all required permits and certificates so that they are readily accessible at the Site.

### **5.5.14 NON-EXCLUSIVE OBLIGATIONS**

The specific requirements of Article 5 are not intended to exclude the obligation of the Subcontractor to comply with any of the other provisions of the General Conditions and the other Contract Documents which are relevant to the proper performance of its portion of the Work.

## **ARTICLE 6**

### **CONSTRUCTION BY OWNER OR BY SEPARATE CONTRACTORS**

#### **6.1 OWNER'S RIGHT TO PERFORM CONSTRUCTION AND TO AWARD SEPARATE CONTRACTS**

##### **6.1.1 OWNER'S RIGHTS**

The Owner reserves the right to perform Project work related to the Contract with the Owner's own forces, or to award separate contracts in connection with such other work or other construction or operations on the Site under conditions of the Contract identical or substantially similar to these including those portions related to insurance. Upon the election to perform such work with its own forces or by separate contracts, the Owner shall notify the Contractor. If the Contractor claims that delay or additional cost is involved because of such action by the Owner, the Contractor shall proceed pursuant to Section 4.5 in the Contract Documents.

##### **6.1.2 DESIGNATION AS CONTRACTOR**

When separate contracts are awarded for different portions of the Project or other construction or operations on the Site, the term "Contractor" in the Contract Documents in each of those contracts shall mean the contractor who executes each separate Owner/Contractor agreement.

##### **6.1.3 CONTRACTOR DUTIES**

Although the Owner shall have overall responsibility for coordination and scheduling of the activities of the Owner's own forces and of each separate contractor with the Work of the Contractor, Contractor shall cooperate with Owner. The Contractor shall participate with other separate contractors and the Owner in reviewing their construction schedules when directed to do so. The Contractor shall make any revisions to the construction schedule deemed necessary after a joint review and mutual agreement. The construction schedules shall then constitute the

schedules to be used by the Contractor until subsequently revised.

#### **6.1.4 OWNER OBLIGATIONS**

Unless otherwise provided in the Contract Documents, when the Owner performs work related to the Project with the Owner's own forces, the Owner shall be deemed to be subject to the same obligations, and to have the same rights, which apply to the Contractor under the General Conditions, including, without excluding others, those stated in Article 3, this Article 6 and Articles 10 and 12.

### **6.2 MUTUAL RESPONSIBILITY**

#### **6.2.1 DELIVERY AND STORAGE**

The Contractor shall afford the Owner and separate contractors reasonable opportunity for delivery and storage of their materials and equipment and performance of their activities, and shall connect and coordinate the separate contractors' construction and operations with theirs as required by the Contract Documents.

#### **6.2.2 NOTICE BY CONTRACTOR**

If part of the Contractor's Work depends upon proper execution or results from work by the Owner or a separate contractor, the Contractor shall, prior to proceeding with that portion of the Work, promptly report to the Owner patent discrepancies or defects in such other construction that would render it unsuitable for such proper execution and results. Failure of the Contractor to so report shall constitute an acknowledgment that the Owner's or separate contractors' completed or partially completed construction is fit and proper to receive the Contractor's Work, except as to defects not then reasonably discoverable.

#### **6.2.3 COSTS INCURRED**

Costs, expenses, and damages caused by delays, improperly timed activities, defective construction, or damages to another's work/Work or property shall be borne by the party responsible. Should Contractor cause damage to the work or property of any other contractor on the Project, or to the Project or the property of a third party, or cause any delay to any such contractor or third party, the Contractor shall defend, indemnify and hold Owner harmless for such damage or delay under Section 3.16, above. Owner may withhold from progress payments and/or retention for the cost of such damage or delay.

#### **6.2.4 CORRECTION OF DAMAGE**

The Contractor shall promptly remedy damage wrongfully caused by the Contractor to completed or partially completed construction or to property of the Owner or separate contractors.

### **6.3 OWNER'S RIGHT TO CLEAN UP**

If a dispute arises among the Contractor, separate contractors, and the Owner as to the responsibility under their respective contracts for maintaining the premises and surrounding area free from waste materials and rubbish as described in Section 3.13, the Owner may clean up and allocate the cost among those responsible as the Owner determines to be just.

## **ARTICLE 7**

### **CHANGES IN THE WORK**

#### **7.1 CHANGES**

##### **7.1.1 NO CHANGES WITHOUT AUTHORIZATION**

The Owner reserves the right to change the Work by making such alterations, deviations, additions to, or deletions from the plans and specifications, as may be deemed by the Owner to be necessary or advisable for the proper Completion or construction of the Work contemplated, and Owner reserves the right to require Contractor to perform such work. No adjustment will be made in the Contract unit price of any Contract item regardless of the quantity ultimately required.

Owner shall compensate Contractor with additional money or additional time, or both, as warranted under the Contract Documents for any extra work ordered by the Owner to be performed by Contractor; but such "extra work" shall not include any work or expense (a) that was known by, should have been known by, or was reasonably foreseeable to Contractor at the time of bidding, or (b) for which Contractor is responsible under the Contract Documents. Contractor shall follow the provisions of the Contract Documents, including General Conditions sections 4.5, 7.6, 7.7, and 8.4, when requesting additional money or additional time for such extra work. Contractor shall expeditiously perform all extra work upon direction, even if no agreement has been reached on extra time or money. For all such changes resulting in a credit to Owner, Contractor shall follow Sections 7.5 and 7.7 in providing the credit to Owner. Contractor shall bring all potential credits to the Owner's attention.

There shall be no change whatsoever in the drawings, specifications, or in the Work or payments under the Contract Documents without an executed Change Order, Construction Change Directive, or order by the Owner pursuant to Section 7.1.2. Owner shall not be liable for the cost of any extra work or any substitutions, changes, additions, omissions, or deviations from the Drawings and Specifications unless the same shall have been properly requested under Section 4.5 and authorized by, and the cost thereof approved in writing by, Change Order or Construction Change Directive. Owner shall not be liable for, and Contractor shall bear the burden of, any post-bid escalation in the costs of construction, whether or not foreseeable; but Contractor will retain the benefit of any post-bid cost decreases, whether or not foreseeable, and will retain the right to request additional compensation for cost increases incurred due to Owner delay. No extension of time for performance of the Work shall be allowed hereunder unless request for such extension is properly made under Section 4.5 and such time is thereof approved

in writing by Change Order or Construction Change Directive. The provisions of the Contract Documents shall apply to all such changes, additions, and omissions with the same effect as if originally embodied in the Drawings and Specifications.

### **7.1.2 AUTHORITY TO ORDER MINOR CHANGES**

The Owner has authority to order minor changes in the Work not involving any adjustment in the Contract Sum, an extension of the Contract Time, or a change which is inconsistent with the intent of the Contract Documents. Such changes shall be effected by written Construction Change Directive and shall be binding on the Contractor. The Contractor shall carry out such written orders promptly.

## **7.2 CHANGE ORDERS (“CO”)**

A CO is a written instrument signed by the Owner and the Contractor, stamped (or sealed) and signed by Architect, and approved by the Owner’s Governing Board and DSA, stating the agreement of Owner and Contractor upon all of the following:

- A. A change in the Work;
- B. The amount of the adjustment in the Contract Sum, if any; and
- C. The extent of the adjustment in the Contract Time, if any.

Unless expressly stated otherwise in the CO, any CO executed by Owner and Contractor constitutes and includes full and complete money and time (including but not limited to, adjustments to money and time) for all costs and effects caused by any of the changes described within it. Unless expressly stated otherwise in the CO, in consideration for the money received for the changes described in the CO, Contractor waives all Claims for all costs and effects caused by any of the changes, including but not limited to labor, equipment, materials, delay, extra work, overhead (home and field), profit, direct costs, indirect costs, acceleration, disruption, impaired productivity, time extensions, and any the costs and effects on Subcontractors and suppliers of any tier.

## **7.3 CONSTRUCTION CHANGE DIRECTIVES (“CCD”)**

### **7.3.1 DEFINITION**

A CCD is a written unilateral order signed by the Owner directing performance of the Work or a change in the Work. The CCD may state an adjustment in the Contract Sum, Contract Time, or Milestone Deadline. The Owner may by CCD, without invalidating the Contract, order changes in the Work within the general scope of the Contract consisting of additions, deletions, or other revisions pursuant to Section 7.1.1.

### **7.3.2 USE TO DIRECT CHANGE**

A CCD shall be used in the absence of agreement on the terms of a CO. If Contractor disagrees with the terms of a CCD, it shall nevertheless perform the work directed by the CCD, but it may pursue the Notice of Potential Change, COR and Claim procedures of Section 4.5 if Contractor believes it is entitled to changes in the Contract Sum or Contract Time.

## **7.4 REQUEST FOR INFORMATION (“RFI”)**

### **7.4.1 DEFINITION**

An RFI is a written request prepared by the Contractor asking the Owner to provide additional information necessary to clarify an item which the Contractor feels is not clearly shown or called for in the drawings or specifications, or to address problems which have arisen under field conditions.

### **7.4.2 SCOPE**

The RFI shall reference all the applicable Contract Documents including specification section, detail, page numbers, drawing numbers, and sheet numbers, etc. The Contractor shall make suggestions and/or interpretations of the issue raised by the RFI. An RFI cannot modify the Contract Sum, Contract Time, or the Contract Documents.

### **7.4.3 RESPONSE TIME**

Unless Owner expressly directs otherwise in writing, Contractor shall submit RFIs directly to the Architect, with copies forwarded to the Owner. Contractor shall submit a revised and updated priority schedule with each RFI. The Architect shall endeavor to follow the Contractor’s requested order of priorities. The Owner and Contractor agree that an adequate time period for the Architect (or other designated recipient of the RFI) to respond to an RFI is generally fourteen (14) calendar days after the Architect’s receipt of an RFI, unless the Owner and Contractor agree otherwise in writing. However, in all cases, the Architect shall take such time, whether more or less than 14 days, as is necessary in the Architect’s professional judgment to permit adequate review and evaluation of the RFI. If Contractor informs the Architect that it needs a response to an RFI expedited to avoid delay to the critical path, the Architect shall provide a response as quickly as reasonably possible. The total time required for the Architect to respond is subject to the complexity of the RFI, the number of RFI’s submitted concurrently and the reprioritization of pending RFI’s submitted by the Contractor, among other things. If Contractor believes that the Architect’s response results in a change in the Work that warrants additional money or time, or that Architect’s response was unreasonably delayed and caused delay to the Work’s critical path, Contractor shall follow the procedures for additional money or time under Section 4.5. No presumption shall arise as to the timeliness of the response if the response is more than fourteen (14) days after the Architect’s receipt of the RFI. Contractor shall review the Contract Documents before submitting an RFI to ensure that the information is not already in the Contract Documents. To compensate the Owner for time and costs incurred for each time the information was already in the Contract Documents, Owner may withhold \$100 from progress payments or

retention in addition to any other remedies which Owner may have the right to pursue.

#### **7.4.4 COSTS INCURRED**

The Contractor shall be invoiced by the Owner for any costs incurred for professional services, which shall be withheld from progress payments or retention, if an RFI requests an interpretation or decision of a matter where the information sought is equally available to the party making such request.

### **7.5 REQUEST FOR PROPOSAL (“RFP”)**

#### **7.5.1 DEFINITION**

An RFP is Owner’s written request asking the Contractor to submit to the Owner an estimate of the effect, including credits, of a proposed change on the Contract Sum and the Contract Time.

#### **7.5.2 SCOPE**

An RFP shall contain adequate information, including any necessary drawings and specifications, to enable Contractor to provide the cost breakdowns required by section 7.7. The Contractor shall not be entitled to any additional money for preparing a response to an RFP, whether ultimately accepted or not.

### **7.6 CHANGE ORDER REQUEST (“COR”)**

#### **7.6.1 DEFINITION**

A COR is any written request prepared by the Contractor asking the Owner for additional money or time, including a “proposed change order” or “PCO.” However, a Claim (see Sections 4.5.3-4.5.6) is not a COR. See Section 4.5.2 for additional COR requirements. The COR shall include all information necessary to establish the Contractor’s entitlement to additional money or time.

#### **7.6.2 CHANGES IN PRICE**

A COR shall include breakdowns per section 7.7 to validate any proposed change in Contract Sum.

#### **7.6.3 CHANGES IN TIME**

Where a change in a Milestone Deadline or Contract Time is requested, a COR shall also include delay analysis to validate any proposed change, and shall meet all requirements in these General Conditions, including but not limited to Section 8.4. Any additional time requested shall not be the number of days to make the proposed change, but must be based upon the impact to the Work schedule as defined in section 3.9 and Division 1 of the Specifications.



## 7.7 PRICE OF CHANGE ORDERS

### 7.7.1 SCOPE

Any COR shall provide in writing to the Owner, the Architect and any construction manager, the effect of the proposed CO upon the Contract Sum and the actual cost of construction, which shall include a complete itemized cost breakdown of all labor and material showing actual quantities, hours, unit prices, wage rates, required for the change, and the effect upon the Contract Time of such CO.

### 7.7.2 DETERMINATION OF COST

The amount of the increase or decrease in the Contract Sum resulting from a CO, if any, shall be determined in one or more of the following ways as applicable to a specific situation:

- A. Mutual acceptance of a lump sum properly itemized and supported by sufficient substantiating data to permit evaluation;
- B. Unit prices stated in the Contractor's original bid, the Contract Documents, or subsequently agreed upon between the Owner and the Contractor;
- C. Cost to be determined in a manner agreed upon by the parties and a mutually acceptable fixed or percentage fee; or
- D. By cost of material and labor and percentage of overhead and profit. If the value is determined by this method the following requirements shall apply:

#### 1. **Daily Reports by Contractor.**

a) General: At the close of each working day, the Contractor shall submit a daily report to the Inspector of Record and any construction manager, on forms approved by the Owner, together with applicable delivery tickets, listing all labor, materials, and equipment involved for that day, the location of the work, and for other services and expenditures when authorized concerning extra work items. An attempt shall be made to reconcile the report daily, and it shall be signed by the Inspector of Record and the Contractor. In the event of disagreement, pertinent notes shall be entered by each party to explain points which cannot be resolved immediately. Each party shall retain a signed copy of the report. Reports by Subcontractors or others shall be submitted through the Contractor.

b) Labor: Show names of workers, classifications, and hours worked.

c) Materials: Describe and list quantities of materials used.

d) Equipment: Show type of equipment, size, identification number,

and hours of operation, including, if applicable, loading and transportation.

e) Other Services and Expenditures: Describe in such detail as the Owner may require.

**2. Basis for Establishing Costs.**

a) Labor will be the actual cost for wages prevailing locally for each craft or type of workers at the time the extra work is done, plus employer payments of payroll taxes and insurance, health and welfare, pension, vacation, apprenticeship funds, and other direct costs resulting from Federal, State, or local laws, as well as assessments or benefits required by lawful collective bargaining agreements. The use of a labor classification, which would increase the extra work cost, will not be permitted unless the Contractor establishes the necessity for such additional costs. Labor costs for equipment operators and helpers shall be reported only when such costs are not included in the invoice for equipment rental.

b) Materials shall be at invoice or lowest current price at which such materials are locally available and delivered to the Site in the quantities involved, plus sales tax, freight, and delivery.

The Owner reserves the right to approve materials and sources of supply or to supply materials to the Contractor if necessary for the progress of the Work. No markup shall be applied to any material provided by the Owner.

c) Tool and Equipment Rental. No payment will be made for the use of tools which have a replacement value of \$100 or less.

Regardless of ownership, the rates to be used in determining equipment rental costs shall not exceed listed rates prevailing locally at equipment rental agencies or distributors at the time the work is performed.

The rental rates paid shall include the cost of fuel, oil, lubrication, supplies, small tools, necessary attachments, repairs and maintenance of any kind, depreciation, storage, insurance, and all incidentals.

Necessary loading and transportation costs for equipment used on the extra work shall be included. If equipment is used intermittently and, when not in use, could be returned to its rental source at less expense to the Owner than holding it at the work Site, it shall be returned unless the Contractor elects to keep it at the work Site at no expense to the Owner.

All equipment shall be acceptable to the Inspector of Record, in good working condition, and suitable for the purpose for which it is to be used. Manufacturer's ratings and modifications shall be used to classify equipment,

and equipment shall be powered by a unit of at least the minimum rating recommended by the manufacturer.

d) Other Items. The Owner may authorize other items which may be required on the extra work. Such items include labor, services, material, and equipment which are different in their nature from those required by the Work, and which are of a type not ordinarily available from the Contractor or any of the Subcontractors. Invoices covering all such items in detail shall be submitted with the Application for Payment.

e) Invoices. Vendors' invoices for material, equipment rental, and other expenditures shall be submitted with the COR. If the Application for Payment is not substantiated by invoices or other documentation, the Owner may establish the cost of the item involved at the lowest price which was current at the time of the Daily Report.

f) Overhead, premiums and profit. For overhead, including direct and indirect costs, submit with the COR and include: home office overhead, off-Site supervision, CO preparation/negotiation/research for Owner initiated changes, time delays, project interference and disruption, additional guaranty and warranty durations, on-Site supervision, additional temporary protection, additional temporary utilities, additional material handling costs, and additional safety equipment costs.

**7.7.3 FORMAT FOR PROPOSED COST CHANGE**

The following format shall be used as applicable by the Owner and the Contractor to communicate proposed additions and deductions to the Contract.

**Work Performed by Subcontractors:**

	<u>EXTRA</u>	<u>CREDIT</u>
A. Material (attach itemized quantity and unit cost plus sales tax, invoices, receipts, truck tags, etc., for force account work)	_____	_____
B. Labor (attach itemized hours and rates, daily logs, certified payroll, etc.)	_____	_____
C. Equipment (attach any invoices)	_____	_____
D. Subtotal	_____	_____

E.	Add Subcontractor's overhead and profit, not to exceed ten percent (10%) of item D.	_____	_____
F.	Subtotal	_____	_____
G.	General Contractor's Overhead and Profit, not to exceed five percent (5%) of Item F.	_____	_____
H.	Subtotal	_____	_____
I.	Bonds and insurance, not to exceed one and a half percent (1.5%) of Item H.	_____	_____
J.	TOTAL	_____	_____
K.	TIME in calendar days (zero unless indicated; "TBD" not permitted)	_____	_____

**Work Performed by Contractor:**

	<b><u>EXTRA</u></b>	<b><u>CREDIT</u></b>	
A.	Material (attach itemized quantity and unit cost plus sales tax, invoices, receipts, truck tags, etc., for force account work)	_____	_____
B.	Labor (attach itemized hours and rates, daily logs, certified payroll, etc.)	_____	_____
C.	Equipment (attach any invoices)	_____	_____
D.	Subtotal	_____	_____
E.	Add Contractor's overhead and profit, not to exceed fifteen percent (15%) of item D.	_____	_____
F.	Subtotal	_____	_____
G.	Bonds and insurance, not to exceed one percent (1.5%) of Item I.	_____	_____

H. TOTAL \_\_\_\_\_

I. TIME in calendar days (zero unless \_\_\_\_\_  
indicated; "TBD" not permitted) \_\_\_\_\_

For any claimed overhead costs (whether field overhead (i.e., general conditions costs) or home office overhead) pursuant to Section 8.4.2 below, Contractor may not recover any mark ups for overhead or profit.

It is expressly understood that the value of such extra work or changes, as determined by any of the aforementioned methods, expressly includes (1) any and all of the Contractor's costs and expenses, both direct and indirect, resulting from additional time required on the project or resulting from delay to the project, and (2) any costs of preparing a COR, including but not limited to delay analysis. Any costs or expenses not included are deemed waived.

**7.7.4 DISCOUNTS, REBATES, AND REFUNDS**

For purposes of determining the cost, if any, of any change, addition, or omission to the Work hereunder, all trade discounts, rebates, refunds, and all returns from the sale of surplus materials and equipment shall accrue and be credited to the Contractor, and the Contractor shall make provisions so that such discounts, rebates, refunds, and returns may be secured, and the amount thereof shall be allowed as a reduction of the Contractor's cost in determining the actual cost of construction for purposes of any change, addition, or omissions in the Work as provided herein.

**7.7.5 ACCOUNTING RECORDS**

With respect to portions of the Work performed by COs and CCDs on a time-and-materials, unit-cost, or similar basis, the Contractor shall keep and maintain cost-accounting records satisfactory to the Owner, which shall be available to the Owner on the same terms as any other books and records the Contractor is required to maintain under the Contract Documents.

**7.7.6 NOTICE REQUIRED**

Contractor shall submit a written Notice of Potential Change for additional money or time pursuant to section 4.5.1.

**7.7.7 APPLICABILITY TO SUBCONTRACTORS**

Any requirements under this Article 7 shall be equally applicable to COs or CCDs issued to Subcontractors by the Contractor to the same extent required of the Contractor.

**7.8 WAIVER OF RIGHT TO CLAIM MONEY OR TIME**

Failure to demand money based on costs, or time extensions, as part of a COR constitutes a complete waiver of Contractor's right to claim the omitted money or time. All money or time for

an issue must be included in the COR at the time submitted.

## **ARTICLE 8**

### **TIME**

#### **8.1 DEFINITIONS**

##### **8.1.1 CONTRACT TIME**

Unless otherwise provided, Contract Time is the period of time, including authorized adjustments, allotted in the Contract Documents for Completion of the Work.

##### **8.1.2 NOTICE TO PROCEED**

Contractor shall not commence the Work until it receives a Notice to Proceed from Owner. The date of commencement of the Work is the date established in the Notice to Proceed. The date of commencement shall not be postponed by the failure to act of the Contractor or of persons or entities for whom the Contractor is responsible.

##### **8.1.3 DAYS**

The term “day” as used in the Contract Documents shall mean calendar day unless otherwise specifically defined.

#### **8.2 HOURS OF WORK**

##### **8.2.1 SUFFICIENT FORCES**

Contractors and Subcontractors shall furnish sufficient forces to ensure the prosecution of the Work, including Work directed pursuant to a CCD (see Section 7.3, above), in accordance with the Construction Schedule.

##### **8.2.2 PERFORMANCE DURING WORKING HOURS**

Work shall be performed during regular working hours except that in the event of an emergency or when required to perform the Work in accordance with job progress, Work may be performed outside of regular working hours with the advance written consent of the Owner.

##### **8.2.3 LABOR CODE APPLICATION**

As provided in Article 3 (commencing at § 1810), Chapter 1, Part 7, Division 2 of the Labor Code, eight (8) hours of labor shall constitute a legal day’s work. The time of service of any worker employed at any time by the Contractor or by any Subcontractor on any subcontract under this Contract, upon the Work or upon any part of the Work contemplated by this Contract, is limited and restricted to eight (8) hours during any one calendar day and forty (40) hours

during any one calendar week, except as hereinafter provided. Notwithstanding the provision hereinabove set forth, Work performed by employees of Contractors in excess of eight (8) hours per day and forty (40) hours during any one week shall be permitted upon this public work with compensation provided for all hours worked in excess of eight (8) hours per day at not less than one and one-half (1-1/2) times the basic rate of pay.

Contractor or subcontractor shall pay to the Owner a penalty of Twenty-five Dollars (\$25.00) for each worker employed in the execution of this Contract by the Contractor, or by any Subcontractor, for each calendar day during which such worker is required or permitted to work more than eight (8) hours in any calendar day and forty (40) hours in any one (1) calendar week, in violation of the provisions of Article 3 (commencing at § 1810), Chapter 1, Part 7, Division 2 of the Labor Code, unless compensation for the workers so employed by Contractor is not less than one and one-half (1-1/2) times the basic rate of pay for all hours worked in excess of eight (8) hours per day.

#### **8.2.4 COSTS FOR AFTER HOURS INSPECTIONS**

If the work done after hours is required by the Contract Documents to be done outside the Contractor's or the Inspector of Record's regular working hours, the costs of any inspections, if required to be done outside normal working hours, shall be borne by the Owner.

If the Owner allows the Contractor to do work outside regular working hours for the Contractor's own convenience, the costs of any inspections required outside regular working hours, among other remedies, shall be invoiced to the Contractor by the Owner and withheld from progress payments and/or retention. Contractor shall give Owner at least 48 hours notice prior to working outside regular working hours.

If the Contractor elects to perform work outside the Inspector of Record's regular working hours, costs of any inspections required outside regular working hours, among other remedies, may be invoiced to the Contractor by the Owner and withheld from progress payments and/or retention.

#### **8.2.5 TIME FOR COMMENCEMENT BY SUBCONTRACTORS**

Unless otherwise provided in the Contract Documents, all Subcontractors shall commence their Work within two (2) consecutive business days after notice to them by the Contractor and shall prosecute their Work in accordance with the progress of the Work.

### **8.3 PROGRESS AND COMPLETION**

#### **8.3.1 TIME OF THE ESSENCE**

Time limits stated in the Contract Documents are of the essence of the Contract. By executing the Agreement the Contractor confirms that the Milestone Deadlines and Contract Time are reasonable periods for performing the Work.

### 8.3.2 NO COMMENCEMENT WITHOUT INSURANCE

The Contractor shall not knowingly, except by agreement or instruction of the Owner, in writing, commence operations on the Site or elsewhere prior to the effective date of insurance required by Article 11 to be furnished by the Contractor. The date of commencement of the Work shall not be changed by the effective date of such insurance.

### 8.3.3 EXPEDITIOUS COMPLETION

The Contractor shall proceed expeditiously to perform the Work, including Work directed pursuant to a CCD (see Section 7.3, above), with adequate forces, labor, materials, equipment, services and management, shall achieve all Milestone Deadlines, and shall achieve Completion within the Contract Time.

## 8.4 EXTENSIONS OF TIME - LIQUIDATED DAMAGES

Contractor waives all rights and remedies as to any delay experienced during the Work (including any right to rescind the Contract and any right to refuse to perform the Contract) except for the rights and remedies expressly allowed by the Contract (including but not limited to time extensions and delay damages pursuant to this Section 8.4.1 and Section 8.4.2 below, and termination pursuant to Section 14.1 below).

### 8.4.1 CONDITIONS ALLOWING FOR EXTENSIONS OF TIME TO COMPLETE THE WORK ONLY (EXCUSABLE DELAY)

The Contractor shall be granted a reasonable time extension under the Contract Documents, including but not limited to Sections 3.18 and 4.5 and Article 7, for excusable delays, which are those delays that meet each and every of the following conditions:

- (a) The delay was beyond the control of Contractor and its subcontractors and material suppliers;
- (b) The delay was caused by events that were not reasonably foreseeable to Contractor at the time of bidding;
- (c) All float in the schedule had been used, and the delay impacted and delayed the controlling items of Work (i.e., the as-built critical path, as determined from the as-planned schedule and the actual progress of the Work), thus delaying the achievement of a Milestone Deadline or the Completion of the whole Work within the Contract Time;
- (d) The delay was not caused by Contractor or its subcontractors or suppliers, including but not limited to their breaches of contract or the standard of care;
- (e) The delay was not associated with loss of time resulting from the necessity of submittals to Owner for approval, or from necessary Owner surveys, measurements, inspections and testing; and
- (f) The delay could not have been prevented or mitigated by the exercise of care, prudence, foresight, and diligence by Contractor.



To be entitled to a time extension for excusable delay caused by weather, the Contractor must establish, in addition to (a)-(f) above, that the weather delay to the critical path exceeded the number of weather days required to be included in the schedule (see Section 3.9.1, above). For example, if the schedule included two calendar days of weather delay for a particular month, and the Contractor establishes five calendar days of actual weather delay to the critical path, then the Contractor may be entitled to a time extension of three calendar days.

Excusable delays may include acts of God, acts of public enemy, acts of the Owner or anyone employed by it, acts of another contractor in performance of a contract (other than this Contract) with the Owner, fires, floods, epidemics, quarantine restrictions, labor disputes, weather, unforeseen site conditions, or delays of subcontractors due to such causes. Owner shall take into consideration other relevant factors such as concurrent delays. Contractor has the burden of proving that any delay was excusable.

#### **8.4.2 COMPENSABLE DELAY (TIME AND MONEY)**

Compensable delays are those excusable delays for which Contractor is also entitled to money. To be compensable, an excusable delay must be one for which the Owner is responsible, where the delay was unreasonable under the circumstances involved, and where the delay was not within the contemplation of the parties; *however*, Contractor shall not be entitled to monetary compensation when (a) Contractor could have reasonably anticipated the delay and avoided or minimized the cost impacts of it, (b) there was a concurrent delay which does not qualify for monetary compensation under this paragraph, (c) the cause of the delay was reasonably unforeseen by the Owner or the delay was caused by factors beyond the control of the Owner, including but not limited to a delay under Section 2.2.8 above or a delay caused by a utility company's failure to perform despite Owner's reasonable arrangements for such performance; or (d) any other defense available to Owner under law or equity applies. Contractor has the burden of proving that any delay was excusable and compensable, including an analysis that establishes non-concurrency. Compensation shall be limited to field overhead (i.e., general conditions) and home office overhead, as may be allowed by law.

#### **8.4.3 NOTICE BY CONTRACTOR REQUIRED; PROCEDURES FOR DEMANDING ADDITIONAL TIME OR MONEY**

For notice and other required procedures related to requests by Contractor for additional time or money related to delay, Contractor shall comply with the Contract Documents, including but not limited to Sections 3.18 and 4.5, and Article 7, above.

#### **8.4.4 EARLY COMPLETION**

Regardless of the cause therefore, the Contractor may not maintain any Claim or cause of action against the Owner for damages incurred as a result of its failure or inability to Complete its Work on the Project in a shorter period than established in the Contract Documents, the parties stipulating that the period set forth in the Contract Documents is a reasonable time within which to perform the Work on the Project.

#### **8.4.5 LIQUIDATED DAMAGES**

Failure to Complete the Work within the Contract Time and in the manner provided for by the Contract Documents, or failure to complete any specified portion of the Work by a milestone deadline, shall subject the Contractor to liquidated damages as described in Article III of the Agreement and the Contract Documents. Accordingly, the parties agree that the amount set forth in the Agreement shall be presumed to be the amount of damages which the Owner shall directly incur as a result of each calendar day by which Completion of the Work is delayed beyond the Contract Time as adjusted by Change Orders.

In addition, delaying another contractor's work on the Project or causing delay to the *completion* of the Project shall subject the Contractor to liquidated damages as described in Article III of the Agreement and the Contract Documents. Accordingly, the parties agree that the amount set forth in the Agreement shall be presumed to be the amount of damages which the Owner shall directly incur as a result of each calendar day by which Contractor delays the work of others on the Project or *completion* of the Project itself.

If liquidated damages accrue as described above, the Owner, in addition to all other remedies provided by law, shall have the right to assess and withhold as provided in Article III of the Agreement and the Contract Documents.

#### **8.5 GOVERNMENT APPROVALS**

Owner shall not be liable for any delays or damages related to the time required to obtain government approvals.

### **ARTICLE 9**

#### **PAYMENTS AND COMPLETION**

##### **9.1 CONTRACT SUM**

The Contract Sum is stated in the Agreement, later adjusted by Change Orders and Construction Change Directives, and is the total amount payable by the Owner to the Contractor for performance of the Work under the Contract Documents.

##### **9.2 COST BREAKDOWN**

###### **9.2.1 REQUIRED INFORMATION**

On forms approved by the Owner, the Contractor shall furnish the following:

- A. Within ten (10) days of the mailing, faxing or delivering of the Notice of Award of the Contract, a detailed breakdown of the Contract Sum (Schedule of Values) for the Work. Each item in the schedule of values shall include its proper share of the overhead and profit.

- B. Within ten (10) days of the mailing, faxing or delivering of the Notice of Award of the Contract, a schedule of estimated monthly payment requests (cash flow) due the Contractor showing the values and construction time of the various portions of the Work to be performed by it and by its Subcontractors or material and equipment suppliers containing such supporting evidence as to its correctness as the Owner may require;
- C. Five (5) days prior to the submission of a pay request, an itemized breakdown of work done for the purpose of requesting partial payments;
- D. Within ten (10) days of the mailing, faxing or delivering of the Notice of Award of the Contract, the name, address, telephone number, fax number, license number and classification, and (for all projects over Twenty-Five Thousand Dollars (\$25,000)) the public works contractor registration number of all of its Subcontractors and of all other parties furnishing labor, material, or equipment for its Contract, along with the amount of each such subcontract or the price of such labor, material, and equipment needed for its entire portion of the Work.

## **9.2.2 OWNER ACCEPTANCE REQUIRED**

The Owner shall review all submissions received pursuant to paragraph 9.2.1 in a timely manner. All submissions must be accepted by the Owner before becoming the basis of any payment.

## **9.3 APPLICATIONS FOR PAYMENT**

### **9.3.1 PROCEDURE**

On or before the fifth (5th) day of each calendar month during the progress of the portion of the Work for which payment is being requested, the Contractor shall submit to the Architect, unless there is a construction manager for the Project or the Owner directs otherwise, an itemized Application for Payment for operations completed in accordance with the Schedule of Values through the end of the previous calendar month. Such application shall be notarized, if required, and supported by the following:

- A. The amount paid to the date of the Application to the Contractor, to all its Subcontractors, and all others furnishing labor, material, or equipment for its Contract;
- B. The amount being requested with the Application for Payment by the Contractor on its own behalf and separately stating the amount requested on behalf of each of the Subcontractors and all others furnishing labor, material, and equipment under the Contract;
- C. The balance that will be due to each of such entities after said payment is made;

- D. A certification that the Record Drawings and Annotated Specifications are current;
- E. The Owner approved additions to and subtractions from the Contract Sum and Time;
- F. A summary of the retentions (each Application shall provide for retention, as set out in Article 9.6);
- G. Material invoices, evidence of equipment purchases, rentals, and other support and details of cost as the Owner may require from time to time;
- H. The percentage of Completion of the Contractor's Work by line item in the schedule of values;
- I. A statement showing all payments made by the Contractor for labor and materials on account of the Work covered in the preceding Application for Payment. Such applications shall not include requests for payment of amounts the Contractor does not intend to pay to subcontractors or others because of a dispute or other reason;
- J. Conditional and unconditional waivers and releases in exchange for progress payments, including final progress payments, in compliance with Civil Code sections 8132-8138;
- K. Contractor's monthly reports, daily reports, and monthly schedule updates for all months of Work prior to the Application for Payment that Contractor has not previously submitted;
- L. Certification that all required certified payroll records have been submitted to the DIR; and
- M. A report regarding the status of all stop payment notices that have been submitted, or a statement that no stop payment notices have been submitted.

### 9.3.2 PURCHASE OF MATERIALS AND EQUIPMENT

As the Contractor is required to order, obtain, and store materials and equipment sufficiently in advance of its Work at no additional cost or advance payment from Owner, to assure that there will be no delays, payment by the Owner for stored material shall be made only in unusual circumstances where the Architect specifically recommends, and Owner specifically approves the payment in writing. If payments are to be made on account of materials and equipment not incorporated in the Work, but delivered and suitably stored at the Site or at some other location agreed upon in writing by the Owner, the payments shall be conditioned upon submission by the Contractor, Subcontractor, or vendor of bills of sale and such other documents satisfactory to the

Owner to establish the Owner's title to such materials or equipment free of all liens and encumbrances, and otherwise protect the Owner's interest, including, without limitation, provision of applicable insurance and transportation to the Site. All stored items shall be inventoried, specified by identification numbers (if applicable), released to the Owner by sureties of the Contractor and the Subcontractor and, if stored off-Site, stored only in a bonded warehouse.

### **9.3.3 WARRANTY OF TITLE**

The Contractor warrants that title to all Work covered by an Application for Payment will pass to the Owner no later than the time of payment. The Contractor further warrants that upon submittal of an Application for Payment all Work for which Certificates for Payment have been previously issued and payments received from the Owner shall, to the best of the Contractor's knowledge, information, and belief, be free and clear of liens, claims, security interests, or encumbrances in favor of the Contractor, Subcontractors, material and equipment suppliers, or other persons or entities making a claim by reason of having provided labor, materials, and equipment relating to the Work. Transfer of title to Work does not constitute a waiver by Owner of any defects in the Work.

## **9.4 REVIEW OF PROGRESS PAYMENT**

### **9.4.1 OWNER ACCEPTANCE**

The Owner will, within seven (7) days after receipt of the Contractor's Application for Payment, either accept such payment or notify the Contractor in writing of the Owner's reasons for withholding acceptance in whole or in part.

### **9.4.2 OWNER'S REVIEW**

The review of the Contractor's Application for Payment by the Owner will be based, at least in part, on the Owner's observations at the Site and the data comprising the Application for Payment that the Work has progressed to the point indicated. The review is also subject to an evaluation of the Work for conformance with the Contract Documents, to results of subsequent tests and inspections, to minor deviations from the Contract Documents correctable prior to Completion, and to specific qualifications expressed by the Owner. The Owner may reject the Application for Payment if it is not complete under section 9.3. The issuance of a Certificate for Payment will constitute a representation that the Contractor is entitled to payment in the amount certified, subject to any withholdings under Section 9.5.1 or any specific qualifications Owner expresses in the Certificate for Payment. However, Contractor's entitlement to payment may be affected by subsequent evaluations of the Work for conformance with the Contract Documents, test and inspections and discovery of minor deviations from the Contract Documents correctable prior to Completion. The issuance of a Certificate for Payment will not be a waiver by the Owner of any defects in the Work covered by the Application for Payment, nor will it be a representation that the Owner has:

- A. Made exhaustive or continuous on-Site inspections to check the quality or

quantity of the Work;

- B. Reviewed construction means, methods, techniques, sequences, or procedures;
- C. Reviewed copies of requisitions received from Subcontractors, material and equipment suppliers, and other data requested by the Owner to substantiate the Contractor's right to payment; or
- D. Made an examination to ascertain how or for what purpose the Contractor has used money previously paid on account of the Contract Sum.

## 9.5 DECISIONS TO WITHHOLD PAYMENT

### 9.5.1 REASONS TO WITHHOLD PAYMENT

The Owner may withhold from a progress payment, in whole or in part, to such extent as may be necessary to protect the Owner due to any of the following:

- A. Defective or incomplete Work not remedied;
- B. Stop Payment Notices. For any stop payment notice, the Owner shall withhold the amount stated in the stop payment notice, the stop notice claimant's anticipated interest and court costs and an amount to provide for the Owner's reasonable cost of any litigation pursuant to the stop payment notice. For any stop payment notice action the parties resolve before judgment is entered, Owner has the right to permanently withhold for any reasonable cost of litigation for that stop payment notice, even if it exceeds the amount originally withheld by Owner for the estimated reasonable cost of litigation. However, if (1) the Contractor at its sole expense provides a bond or other security satisfactory to the Owner in the amount of at least one hundred twenty-five percent (125%) of the claim, in a form satisfactory to the Owner, which protects the Owner against such claim, and (2) the Owner chooses to accept the bond, then Owner would release the withheld stop payment notice funds to the Contractor, except that Owner may permanently withhold for any reasonable cost of litigation. Any stop payment notice release bond shall be executed by a California admitted, fiscally solvent surety, completely unaffiliated with and separate from the surety on the payment and performance bonds, that does not have any assets pooled with the payment and performance bond sureties.
- C. Liquidated damages against the Contractor, whether already accrued or estimated to accrue in the future;
- D. Reasonable doubt that the Work can be Completed for the unpaid balance of any Contract Sum or within the Contract Time;
- E. Damage to the property or work of the Owner, another contractor, or

subcontractor;

- F. Unsatisfactory prosecution of the Work by the Contractor;
- G. Failure to store and properly secure materials;
- H. Failure of the Contractor to submit on a timely basis, proper and sufficient documentation required by the Contract Documents, including, without limitation, monthly progress schedules, shop drawings, submittal schedules, schedule of values, product data and samples, proposed product lists, executed change orders, and verified reports;
- I. Failure of the Contractor to maintain record drawings;
- J. Erroneous estimates by the Contractor of the value of the Work performed, or other false statements in an Application for Payment;
- K. Unauthorized deviations from the Contract Documents;
- L. Failure of the Contractor to prosecute the Work in a timely manner in compliance with established progress schedules and Completion deadlines;
- M. Subsequently discovered evidence or observations nullifying the whole or part of a previously issued Certificate for Payment;
- N. Failure by Contractor to pay Subcontractors or material suppliers as required by Contract or law, which includes but is not limited to Contractor's failure to pay prevailing wage and any assessment of statutory penalties;
- O. Overpayment to Contractor on a previous payment;
- P. Credits owed to Owner for reduced scope of work or work that Contractor will not perform, including credits for any unspent allowance;
- Q. The estimated cost of performing work pursuant to Section 2.4;
- R. Actual damages related to false claims by Contractor;
- S. Breach of any provision of the Contract Documents;
- T. Owner's potential or actual loss, liability or damages caused by the Contractor, including defense costs and attorneys' fees incurred due to Contractor's failure to defend an action pursuant to the indemnity provisions in the Contract Documents; and
- U. As permitted by other provisions in the Contract or as otherwise allowed by law,

including statutory penalties Owner or other entities assessed against Contractor. (See e.g., Labor Code section 1813 (working hours) or Public Contract Code section 4110 (subcontractor listings and substitutions))

Owner may, but is not required to, provide to Contractor written notice of the items for which Owner is withholding amounts from a progress payment.

To claim a breach of contract or violation of law based on wrongful withholding by the Owner from a progress payment or based on a late progress payment, or if Contractor otherwise disputes any progress payment or lack thereof, within fifteen (15) days of the alleged breach of contract, violation of law, or late or disputed progress payment Contractor shall submit a Claim pursuant and subject to Sections 4.5.3-4.5.6. The Contractor need not submit a Notice of Potential Change or a Change Order Request.

For any withhold amount based on an estimate where the actual amount later becomes known and certain, no later than the final accounting for the Contract the Owner will release any amount withheld over that certain and known amount. If the certain and known amount exceeds the amount previously withheld, Owner may withhold additional amounts from Contractor to cover the excess amount. If available funds are not sufficient, Contractor shall pay Owner the difference.

Despite any withholding from a progress payment, or any other dispute about a progress payment, Contractor shall continue to expeditiously perform the Work pursuant to the Contract Documents, including but not limited to General Conditions sections 4.5.8, 7.1.1, 8.3.1, and 8.3.3.

#### **9.5.2 PAYMENT AFTER CURE**

When Contractor removes or cures the grounds for withholding amounts, payment shall be made for amounts withheld because of them. No interest shall be paid on any retainage or amounts withheld due to the failure of the Contractor to perform in accordance with the terms and conditions of the Contract Documents.

#### **9.5.3 OVERPAYMENT AND/OR FAILURE TO WITHHOLD**

Neither Owner's overpayment to Contractor, nor Owner's failure to withhold an amount from payment that Owner had the right to withhold, shall constitute a waiver by Owner of its rights to withhold those amounts from future payments to Contractor or to otherwise pursue recovery of those amounts from Contractor.

### **9.6 PROGRESS PAYMENTS**

#### **9.6.1 PAYMENTS TO CONTRACTOR**

Progress payments shall be made in accordance with Public Contract Code sections 7201, 9203, and 20104.50. Unless otherwise stated in the Contract Documents, within thirty (30) days after



receipt of an undisputed and properly submitted Application for Payment (“properly submitted” means in compliance with the law and the Contract Documents, including submittal of all documents required to accompany the Application [see Section 9.3.1, above]), Contractor shall be paid a sum equal to ninety-five percent (95%) of the undisputed value of the Work performed up to the last day of the previous month, less the aggregate of previous payments; and Owner shall withhold the other five percent (5%) of the undisputed value of the Work as retainage (or “retention”). The value of the Work completed shall be an estimate only, no inaccuracy or error in said estimate shall operate to release the Contractor, or any bondsman, from damages arising from such Work or from enforcing each and every provision of this Contract, and the Owner shall have the right subsequently to correct any error made in any estimate for payment. Contractor shall base an Application for Payment only on the original Contract Sum plus any fully executed and Board-approved Change Orders. Contractor shall not include Notices of Potential Claims, CORs, Claims or disputed amounts.

The Contractor shall not be entitled to have any payment requests processed, or be entitled to have any payment made for work performed, so long as any lawful or proper direction given by the Owner concerning the Work, or any portion thereof, remains uncomplied with. Payment shall not be a waiver of any such direction.

#### **9.6.2 PAYMENTS TO SUBCONTRACTORS**

No later than ten (10) days after receipt of payment from Owner, pursuant to Business and Professions Code section 7108.5, the Contractor shall pay to each Subcontractor, out of the amount paid to the Contractor on account of such Subcontractor’s portion of the Work, the amount to which said Subcontractor is entitled, reflecting percentages actually retained from payments to the Contractor on account of such Subcontractor’s portion of the Work. The Contractor shall, by appropriate agreement with each Subcontractor, require each Subcontractor to make payments to Sub-subcontractors in a similar manner.

#### **9.6.3 PERCENTAGE OF COMPLETION OR PAYMENT INFORMATION**

The Owner will, on request, furnish to a Subcontractor, if practicable, information regarding percentages of Completion or amounts applied for by the Contractor, and action taken thereon by the Owner, on account of portions of the Work done by such Subcontractor.

#### **9.6.4 NO OBLIGATION OF OWNER FOR SUBCONTRACTOR PAYMENT**

The Owner shall have no obligation to pay, or to see to the payment of, money to a Subcontractor except as may otherwise be required by law.

#### **9.6.5 PAYMENT TO SUPPLIERS**

Payment to material or equipment suppliers shall be treated in a manner similar to that provided in paragraphs 9.6.2, 9.6.3 and 9.6.4.

#### **9.6.6 PAYMENT NOT CONSTITUTING APPROVAL OR ACCEPTANCE**

An accepted Application for Payment, issuance of a Certificate for Payment, a progress payment, or partial or entire use or occupancy of the Project by the Owner shall not constitute acceptance or approval of any portion of the Work, especially any Work not in accordance with the Contract Documents.

#### **9.6.7 JOINT CHECKS**

Owner shall have the right, if necessary for the protection of the Owner, to issue joint checks made payable to the Contractor and Subcontractors and/or material or equipment suppliers. The joint check payees shall be responsible for the allocation and disbursement of funds included as part of any such joint payment. However, Owner has no duty to issue joint checks. In no event shall any joint check payment be construed to create any contract between the Owner and a Subcontractor of any tier, any obligation from the Owner to such Subcontractor, or rights in such Subcontractor against the Owner.

### **9.7 COMPLETION OF THE WORK**

#### **9.7.1 CLOSE-OUT PROCEDURES**

When the Contractor considers that the Work is Complete and submits a written notice to Owner requesting an inspection of the Work, the Owner shall review the Work and prepare and submit to the Contractor a comprehensive list of items to be Completed or corrected (the "Punch List"). The Punch List shall include all outstanding obligations of Contractor, including training, start-up, testing, and submission to Owner of all required documentation (e.g., written guarantees, warranties, invoices, as-built drawings, manuals, bonds, and the documents described in Sections 9.3 and 9.9). The Contractor and/or its Subcontractors shall proceed promptly to Complete and correct items on the Punch List. Failure to include an item on the Punch List does not alter the responsibility of the Contractor to Complete all Work (including the omitted item) in accordance with the Contract Documents, and to Complete or correct the Work so long as the statute of limitations (or repose) has not run.

When the Contractor believes the Punch List Work is Complete and in accordance with the Contract Documents, it shall then submit a request for an additional inspection by the Owner to determine Completion. Owner shall again inspect the Work and inform the Contractor of any items that are not complete or correct. Contractor shall promptly Complete or correct items until no items remain.

After the Work, including all Punch List Work, is inspected and informally deemed by the Owner to be Complete, the Owner's governing body may formally accept the Work as Complete at a meeting of the governing body. Warranties required by the Contract Documents shall commence on the date of Contractor's Completion of the Work (see Sections 3.5, 12.2.5, and 12.2.6).

Owner may record a Notice of Completion as allowed by Civil Code section 9200 *et seq.*

## **9.7.2 COSTS OF MULTIPLE INSPECTIONS**

More than two (2) requests by Contractor to make inspections to confirm Completion as required under paragraph 9.7.1 shall be considered an additional service of Owner, and all subsequent costs will be invoiced to Contractor and withheld from remaining payments.

## **9.8 PARTIAL OCCUPANCY OR USE**

The Owner may occupy or use any completed, or partially completed, portion of the Work at any stage prior to acceptance, or prior to Completion if there is no formal acceptance. Occupancy or use of any portion of the Work, or the whole Work, shall not constitute approval or acceptance of it, nor shall such occupancy or use relieve Contractor of any of its obligations under the Contract Documents regarding that portion of, or the whole, Work.

The Owner and the Contractor shall agree in writing to the responsibilities assigned to each of them for payments, security, maintenance, heat, utilities, damage to the Work, insurance, the period for correction of the Work, and the commencement of warranties required by the Contract Documents. When the Contractor considers a portion complete, the Contractor may request an inspection of that portion and preparation of a Punch List by the Owner for that portion, as set forth for the entire Work under paragraph 9.7.1; however, such inspection and Punch List shall not act as any form of approval or acceptance of that portion of the Work, or of any Work not complying with the requirements of the Contract, and that portion shall be subject to subsequent inspections and Punch Lists.

Immediately prior to such partial occupancy or use, the Owner, the Architect and the Contractor shall jointly inspect the area to be occupied or portion of the Work to be used in order to determine and record the condition of the Work.

## **9.9 FINAL PROGRESS PAYMENT AND RELEASE OF RETENTION**

### **9.9.1 FINAL APPLICATION FOR PROGRESS PAYMENT**

When, pursuant to Section 9.7.1, the Owner finds all of the Work is Completed in accordance with the Contract Documents, it shall so notify Contractor, who shall then submit to the Owner its final Application for Payment.

Upon receipt and approval of such final Application for Payment, the Owner shall issue a final Certificate of Payment, based on its knowledge, information, and belief, and on the basis of its observations, inspections, and all other data accumulated or received by the Owner in connection with the Work, that such Work has been Completed in accordance with the Contract Documents. If required to do so under Labor Code section 1773.3(d), Owner shall withhold final payment.

### **9.9.2 PROCEDURES FOR APPLICATION FOR FINAL PROGRESS PAYMENT**

The Application for Final Progress Payment pursuant to Section 9.9.1 shall be accompanied by

the same details as set forth in Section 9.3, and in addition, the following conditions must be fulfilled:

- A. The Work shall be Complete, and the Contractor shall have made, or caused to have been made, all corrections to the Work which are required to remedy any defects therein, to obtain compliance with the Contract Documents or any requirements of applicable codes and ordinances, or to fulfill any of the orders or directions of Owner required under the Contract.
- B. Each Subcontractor shall have delivered to the Contractor all written guarantees, warranties, applications, and bonds required by the Contract Documents for its portion of the Work, and Contractor delivered them to the Owner.
- C. The Contractor shall deliver to the Owner (i) reproducible final Record Drawings and Annotated Specifications showing the Contractor's Work "as built," with the Contractor's certification of the accuracy of the Record Drawings and Annotated Specifications, (ii) all warranties and guarantees, (iii) operation and maintenance instructions, manuals and materials for equipment and apparatus, and (iv) all other documents required by the Contract Documents.
- D. Contractor shall provide extensive assistance in the utilization of any equipment or system such as initial start-up or testing, adjusting and balancing, preparation of operation and maintenance manuals and training personnel for operation and maintenance.

Acceptance of Final Progress Payment shall constitute a complete waiver of Claims except for those previously identified in writing and identified by that payee as unsettled at the time of Final Progress Payment.

### **9.9.3 RELEASE OF RETAINAGE**

Owner shall withhold not less than 5% of the Contract Sum ("retainage," or "retention") until Completion and acceptance of the Project, per Public Contract Code section 9203.

Owner may withhold from release or payment of retainage up to 150% of disputed amounts, including but not limited to the issues listed in Section 9.5. If retainage is held in an escrow account pursuant to an escrow agreement under Public Contract Code section 22300 (see Section 9.10) and Owner withholds from release of retainage based on a breach of the Contract, or other default, by Contractor, Owner may withdraw the withheld retainage from the escrow account.

Owner shall release the undisputed retainage within sixty (60) days after Completion of the Project. For this purpose, "Completion" is defined in Public Contract Code section 7107(c). No interest shall be paid on any retainage, or on any amounts withheld, except as provided to the contrary in any Escrow Agreement and General Conditions between the Owner and the

Contractor under Public Contract Code section 22300.

To claim a breach of contract or violation of law based on wrongful withholding by the Owner from retention or based on a late payment or late release of retention, or if Contractor otherwise disputes any payment or release of retention or lack thereof, within fifteen (15) days of the alleged breach of contract, violation of law, or late or disputed payment/release of retention Contractor shall submit a Claim pursuant and subject to Sections 4.5.3-4.5.6. The Contractor need not submit a Notice of Potential Change or a Change Order Request.

#### **9.10 SUBSTITUTION OF SECURITIES**

In accordance with section 22300 of the Public Contract Code, the Owner will permit the substitution of securities for any retention monies withheld by the Owner to ensure performance under the Contract. At the request and expense of the Contractor, securities equivalent to the amount withheld shall be deposited with the Owner, or with a state or federally chartered bank as the escrow agent, who shall then pay such retention monies to the Contractor. Upon Completion of the Contract, the securities shall be returned to the Contractor if Owner has no basis to withhold under the Contract Documents.

Securities eligible for investment under this section shall include those listed in Government Code section 16430, bank or savings and loan certificates of deposit, interest-bearing, demand-deposit accounts, standby letters of credit, or any other security mutually agreed to by the Contractor and the Owner.

The Contractor shall be the beneficial owner of any securities substituted for monies withheld and shall receive any interest thereon.

Any escrow agreement entered by Owner and Contractor pursuant to Public Contract Code section 22300, shall be substantially similar to the form set forth in Public Contract Code section 22300.

### **ARTICLE 10**

#### **PROTECTION OF PERSONS AND PROPERTY**

##### **10.1 SAFETY PRECAUTIONS AND PROGRAMS**

###### **10.1.1 CONTRACTOR RESPONSIBILITY**

The Contractor shall have responsibility for initiating, maintaining, and supervising all safety precautions and programs in connection with the performance of the Contract. Each Contractor shall designate a responsible member of its organization whose duties shall include loss and accident prevention, and who shall have the responsibility and full authority to enforce the program. This person shall attend meetings with the representatives of the various Subcontractors employed to ensure that all employees understand and comply with the programs. Contractor will ensure that his employees and Subcontractors cooperate and coordinate safety matters with any

other contractors on the Project to form a joint safety effort.

#### **10.1.2 SUBCONTRACTOR RESPONSIBILITY**

Subcontractors have the responsibility for participating in, and enforcing, the safety and loss prevention programs established by the Contractor for the Project, which will cover all Work performed by the Contractor and its Subcontractors. Each Subcontractor shall designate a responsible member of its organization whose duties shall include loss and accident prevention, and who shall have the responsibility and full authority to enforce the program. This person shall attend meetings with the representatives of the various Subcontractors employed to ensure that all employees understand and comply with the programs.

#### **10.1.3 COOPERATION**

All Subcontractors and material or equipment suppliers, shall cooperate fully with Contractor, the Owner, and all insurance carriers and loss prevention engineers.

#### **10.1.4 ACCIDENT REPORTS**

Subcontractors shall promptly report in writing to the Contractor all accidents whatsoever arising out of, or in connection with, the performance of the Work, whether on or off the Site, which caused death, personal injury, or property damage, giving full details and statements of witnesses. In addition, if death or serious injuries or serious damages are caused, the accident shall be reported immediately by telephone or messenger. Contractor shall thereafter promptly report the facts in writing to the Owner giving full details of the accident.

#### **10.1.5 FIRST-AID SUPPLIES AT SITE**

The Contractor will provide and maintain at the Site first-aid supplies for minor injuries.

### **10.2 SAFETY OF PERSONS AND PROPERTY**

#### **10.2.1 THE CONTRACTOR**

The Contractor shall take reasonable precautions for the safety of, and shall provide reasonable protection to prevent damage, injury, or loss to:

- A. Employees on the Work and other persons who may be affected thereby;
- B. The Work, material, equipment, tools, construction equipment, and machinery to be incorporated therein or necessary for the proper execution and Completion of the Work, whether in storage on or off the Site, under the care, custody, or control of the Contractor or the Contractor's Subcontractors or Sub-subcontractors; and
- C. Other property at the Site or adjacent thereto such as trees, shrubs, lawns, walks, pavement, roadways, structures, and utilities not designated for removal,

relocation, or replacement in the course of construction.

#### **10.2.2 CONTRACTOR NOTICES**

The Contractor shall give notices and comply with applicable laws, ordinances, rules, regulations, and lawful orders of public authorities bearing on the safety of persons or property or their protection from damage, injury, or loss.

#### **10.2.3 SAFETY BARRIERS AND SAFEGUARDS**

The Contractor shall erect and maintain, as required by existing conditions and performance of the Contract, reasonable safeguards for safety and protection, including posting danger signs and other warnings against hazards, promulgating safety regulations, and notifying owners and users of adjacent sites and utilities.

#### **10.2.4 USE OR STORAGE OF HAZARDOUS MATERIAL**

When use or storage of explosives, other hazardous materials or equipment, or unusual methods are necessary for execution of the Work, the Contractor shall exercise utmost care and carry on such activities under supervision of properly qualified personnel. The Contractor shall notify the Owner any time that explosives or hazardous materials are expected to be stored on Site. Location of storage shall be coordinated with the Owner and local fire authorities.

#### **10.2.5 FINGERPRINTING**

At its own expense, Contractor shall comply with all fingerprinting requirements under law and Contract, including but not limited to the requirements of Education Code section 45125.2 and the Independent Contractor Student Contact Form which is a part of the Contract. Contractor shall hold harmless, defend and indemnify the Owner under section 3.16, for any costs, including attorneys' fees, Owner incurs from Contractor's failure to comply.

### **10.3 PROTECTION OF WORK AND PROPERTY**

#### **10.3.1 PROTECTION OF WORK**

The Contractor and Subcontractors shall continuously protect the Work, the Owner's property, and the property of others, from damage, injury, or loss until the earlier of formal acceptance of the Work or Completion of the Work. The Contractor and Subcontractors shall make good any such damage, injury, or loss, except such as may be solely due to, or caused by, agents or employees of the Owner; except that for projects not solely funded through revenue bonds, (a) Contractor shall not be responsible for damages caused by a tidal wave to the extent that the damages exceed 5% of the Contract Sum, and (b) Contractor shall not be responsible for damages caused by an earthquake above 3.5 on the Richter Scale in magnitude to the extent that the damages exceed 5% of the Contract Sum, per Public Contract Code §7105(a).

### **10.3.2 PROTECTION FOR ELEMENTS**

The Contractor will remove all mud, water, or other elements as may be required for the proper protection and prosecution of its Work. The Contractor shall at all times provide heat, coverings, and enclosures necessary to maintain adequate protection against weather so as to preserve the Work, materials, equipment, apparatus, and fixtures free from injury or damage.

### **10.3.3 SHORING AND STRUCTURAL LOADING**

The Contractor shall not impose structural loading upon any part of the Work under construction or upon existing construction on or adjacent to the Site in excess of safe limits, or loading such as to result in damage to the structural, architectural, mechanical, electrical, or other components of the Work. The design of all temporary construction equipment and appliances used in construction of the Work and not a permanent part thereof, including, without limitation, hoisting equipment, cribbing, shoring, and temporary bracing of structural steel, is the sole responsibility of the Contractor. All such items shall conform to the requirements of governing codes and all laws, ordinances, rules, regulations, and orders of all authorities having jurisdiction. The Contractor shall take special precautions, such as shoring of masonry walls and temporary tie bracing of structural steel work, to prevent possible wind damage during construction of the Work. The installation of such bracing or shoring shall not damage or cause damage to the Work in place or the Work installed by others. Any damage which does occur shall be promptly repaired by the Contractor at no cost to the Owner.

### **10.3.4 CONFORMANCE WITHIN ESTABLISHED LIMITS**

The Contractor and Subcontractors shall confine their construction equipment, the storage of materials, and the operations of workers to the limits indicated by laws, ordinances, permits, and the limits established by the Owner, and shall not unreasonably encumber the premises with construction equipment or materials.

### **10.3.5 SUBCONTRACTOR ENFORCEMENT OF RULES**

Subcontractors shall enforce the Owner's and the Contractor's instructions, laws, and regulations regarding signs, advertisements, fires, smoking, the presence of liquor, and the presence of firearms by any person at the Site.

### **10.3.6 SITE ACCESS**

The Contractor and the Subcontractors shall use only those ingress and egress routes designated by the Owner, observe the boundaries of the Site designated by the Owner, park only in those areas designated by the Owner, which areas may be on or off the Site, and comply with any parking control program established by the Owner such as furnishing license plate information and placing identifying stickers on vehicles.



### **10.3.7 PROTECTION OF MATERIALS**

The Contractor and the Subcontractors shall receive, count, inspect for damage, record, store, and protect construction materials for the Work and Subcontractors shall promptly send to the Contractor evidence of receipt of such materials, indicating thereon any shortage, change, or damage (failure to so note shall constitute acceptance by the Subcontractor of financial responsibility for any shortage).

## **10.4 EMERGENCIES**

### **10.4.1 EMERGENCY ACTION**

In an emergency affecting the safety of persons or property, the Contractor shall take any action necessary, at the Contractor's discretion, to prevent threatened damage, injury, or loss. Additional money or extension of time claimed by the Contractor on account of an emergency shall be determined as provided in Section 4.5 and Article 7.

### **10.4.2 ACCIDENT REPORTS**

The Contractor shall promptly report in writing to the Owner all accidents arising out of or in connection with the Work, which caused death, personal injury, or property damage, giving full details and statements of any witnesses. In addition, if death, serious personal injuries, or serious property damages are caused, the accident shall be reported immediately by telephone or messenger to the Owner.

## **10.5 HAZARDOUS MATERIALS**

### **10.5.1 DISCOVERY OF HAZARDOUS MATERIALS**

In the event the Contractor encounters or suspects the presence on the Site material reasonably believed to be asbestos, polychlorinated biphenyl (PCB), or any other material defined as being hazardous by section 25249.5 of the California Health and Safety Code, which (a) has not been rendered harmless, and (b) the handling or removal of which is not within the scope of the Work, the Contractor shall immediately stop Work in the area affected and report the condition to the Owner and the Architect in writing, whether such material was generated by the Contractor, another contractor, or the Owner. The Work in the affected area shall not thereafter be resumed, except by written agreement of the Owner and the Contractor, if in fact the material is asbestos, polychlorinated biphenyl (PCB), or other hazardous material, and has not been rendered harmless. The Work in the affected area shall be resumed only in the absence of asbestos, polychlorinated biphenyl (PCB), or other hazardous material, or when it has been rendered harmless by written agreement of the Owner and the Contractor.

### **10.5.2 HAZARDOUS MATERIAL WORK LIMITATIONS**

In the event that the presence of hazardous materials is suspected or discovered on the Site, the Owner shall retain an independent testing laboratory to determine the nature of the material

encountered and whether corrective measures or remedial action is required. The Contractor shall not be required pursuant to Article 7 to perform without consent any Work in the affected area of the Site relating to asbestos, polychlorinated biphenyl (PCB), or other hazardous material, until any known or suspected hazardous material has been removed, or rendered harmless, or determined to be harmless by Owner, as certified by an independent testing laboratory and/or approved by the appropriate government agency.

#### **10.5.3 INDEMNIFICATION BY OWNER FOR HAZARDOUS MATERIAL NOT CAUSED BY CONTRACTOR**

In the event the presence of hazardous materials on the Site is not caused by the Contractor, Owner shall pay for all costs of testing and remediation, if any, and shall compensate Contractor for any delay or additional costs incurred in accordance with the applicable provisions of Articles 7 and 8 herein. Owner shall defend, indemnify and hold harmless the Contractor and its agents, officers, directors and employees from and against any and all claims, damages, losses, costs and expenses incurred in connection with or arising out of, or relating to, the performance of the Work in the area affected by the hazardous material, except to the extent the claims, damages, losses, costs, or expenses were caused by Contractor's active negligence, sole negligence or willful misconduct. By providing this indemnification, Owner does not waive any immunities.

#### **10.5.4 NATURALLY OCCURRING ASBESTOS**

If the Site is found to contain naturally occurring asbestos (asbestos naturally contained in rocks which can become airborne when released "NOA"), in addition to complying with applicable provisions in sections 10.5.1-10.5.3 above, Contractor shall comply with, and be solely responsible for, all applicable NOA requirements of the California Air Resources Board (CARB), California Department of Industrial Relations, California Division of Occupational Safety and Health (Cal/OSHA), any local air quality management district with jurisdiction over the Site, the County, and all other applicable federal, State and local governmental entities. This compliance and responsibility includes, but is not limited to, dust control mitigation measures and a monitoring plan.

#### **10.5.5 INDEMNIFICATION BY CONTRACTOR FOR HAZARDOUS MATERIAL CAUSED BY CONTRACTOR**

In the event the presence of hazardous materials on the Site is caused by Contractor, Subcontractors, materialmen or suppliers, the Contractor shall pay for all costs of testing and remediation, if any, and shall compensate the Owner for any additional costs incurred as a result of the generation of hazardous material on the Project Site. In addition, the Contractor shall defend, indemnify and hold harmless Owner and its agents, officers, and employees from and against any and all claims, damages, losses, costs and expenses incurred in connection with, arising out of, or relating to, the presence of hazardous material on the Site, except to the extent the claims, damages, losses, costs, or expenses were caused by Owner's active negligence, sole negligence or willful misconduct.

#### **10.5.6 TERMS OF HAZARDOUS MATERIAL PROVISION**

The terms of this Hazardous Material provision shall survive the Completion of the Work and/or any termination of this Contract.

#### **10.5.7 ARCHEOLOGICAL MATERIALS**

In the event the Contractor encounters or reasonably suspects the presence on the Site of archeological materials, the Contractor shall immediately stop Work in the area affected and report the condition to the Owner and the Architect in writing. The Work in the affected area shall not thereafter be resumed, except after Contractor's receipt of written notice from the Owner.

### **ARTICLE 11**

#### **INSURANCE AND BONDS**

##### **11.1. CONTRACTOR'S LIABILITY INSURANCE**

###### **11.1.1 LIABILITY INSURANCE REQUIREMENTS**

11.1.1 By the earlier of the deadline set forth in the Instructions to Bidders or the commencement of the Work and within limits acceptable to the Owner, the Contractor shall purchase from and maintain in a company or companies lawfully authorized to do business in California as admitted carriers with a financial rating of at least A+, Class XII status as rated in the most recent edition of Best's Insurance Reports such commercial general liability insurance per occurrence for bodily injury, personal injury and property damage as set forth in the Agreement and automobile liability insurance per accident for bodily injury and property damage combined single limit as set forth in the Agreement as will protect the Contractor from claims set forth below, which may arise out of or result from the Contractor's operations under the Contract and for which the Contractor may be legally liable, whether such operations are by the Contractor, by a Subcontractor, by Sub-subcontractor, by anyone directly or indirectly employed by any of them, or by anyone for whose acts any of them may be liable:

- 11.1.1.1 claims for damages because of bodily injury (including emotional distress), sickness, disease, or death of any person other than the Contractor's employees. This coverage shall be provided in a form at least as broad as Insurance Services Office (ISO) Form CG 0001 11188;
- 11.1.1.2 claims for damages arising from personal or advertising injury in a form at least as broad as ISO Form CG 0001 11188;
- 11.1.1.3 claims for damages because of injury or destruction of tangible property, including loss of use resulting therefrom, arising from operations under the Contract Documents; and

- 11.1.1.4 claims for damages because of bodily injury, death of a person, or property damage arising out of the ownership, maintenance, or use of a motor vehicle, all mobile equipment, and vehicles moving under their own power and engaged in the Work; and
- 11.1.1.5 claims involving blanket contractual liability applicable to the Contractor's obligations under the Contract Documents, including liability assumed by and the indemnity and defense obligations of the Contractor and the Subcontractors; and
- 11.1.1.6 claims involving Completed Operations, Independent Contractors' coverage, and Broad Form property damage, without any exclusions for collapse, explosion, demolition, underground coverage, and excavating. (XCU)

If commercial general liability insurance or another insurance form with a general aggregate limit is used, either the general aggregate limit shall apply separately to the project location (with the ISO CG 2501 or insurer's equivalent endorsement provided to the Owner) or the general aggregate limit shall be twice the required occurrence limit.

Any deductible or self-insured retention must be declared to and approved by the Owner. At the option of the Owner, either the insurer shall reduce or eliminate such deductibles or self-insured retentions as respects the Owner, its Board of Trustees, members of its Board of Trustees, officers, employees, agents and volunteers; or the Contractor shall procure a bond guaranteeing payment of losses and related investigations, claim administration and defense expenses.

#### **11.1.2 SUBCONTRACTOR INSURANCE REQUIREMENTS**

The Contractor shall require its Subcontractors and any Sub-subcontractors to take out and maintain similar public liability insurance and property damage insurance, in a company or companies lawfully authorized to do business in California as admitted carriers with a financial rating of at least A+, Class XII status as rated in the most recent edition of Best's Insurance Reports, in like amounts and scope of coverage.

#### **11.1.3 OWNER'S INSURANCE**

The Owner shall be responsible for purchasing and maintaining the Owner's usual liability insurance. Optionally, the Owner may purchase and maintain other insurance for self protection against claims which may arise from operations under the Contract. The Contractor shall not be responsible for purchasing and maintaining this optional Owner's liability insurance unless specifically required by the Contract Documents.

#### **11.1.4 ADDITIONAL INSURED ENDORSEMENT REQUIREMENTS**

The Contractor shall name, on any policy of insurance, the Owner and the Architect as additional insureds. Subcontractors shall name the Contractor, the Owner and the Architect as additional insureds. The Additional Insured Endorsement included on all such insurance policies shall state that coverage is afforded the additional insured with respect to claims arising out of operations performed by or on behalf of the insured. If the additional insureds have other insurance which is applicable to the loss, such other insurance shall be excess to any policy of insurance required herein. The amount of the insurer's liability shall not be reduced by the existence of such other insurance.

#### **11.1.5 WORKERS' COMPENSATION INSURANCE**

During the term of this Contract, the Contractor shall provide workers' compensation insurance for all of the Contractor's employees engaged in Work under this Contract on or at the Site of the Project and, in case any of the Contractor's work is sublet, the Contractor shall require the Subcontractor to provide workers' compensation insurance for all the Subcontractor's employees engaged in Work under the subcontract. Any class of employee or employees not covered by a Subcontractor's insurance shall be covered by the Contractor's insurance. In case any class of employees engaged in Work under this Contract on or at the Site of the Project is not protected under the Workers' Compensation laws, the Contractor shall provide or cause a Subcontractor to provide adequate insurance coverage for the protection of those employees not otherwise protected. The Contractor shall file with the Owner certificates of insurance as required under this Article and in compliance with Labor Code section 3700.

If the contractor fails to maintain such insurance, the Owner may take out compensation insurance which the Owner might be liable to pay under the provisions of the Act by reason of an employee of the Contractor being injured or killed, and withhold from progress payments and/or retention the amount of the premium for such insurance.

#### **11.1.6 BUILDER'S RISK/"ALL RISK" INSURANCE**

##### **11.1.6.1 COURSE-OF-CONSTRUCTION INSURANCE REQUIREMENTS**

Unless provided by Owner at Owner's sole discretion, Contractor, during the progress of the Work and until final acceptance of the Work by Owner upon Completion of the entire Contract, shall maintain Builder's Risk/Course-of-Construction insurance satisfactory to the Owner, issued on a completed value basis on all insurable Work included under the Contract Documents. This insurance shall insure against all risks, including but not limited to the following perils: Vandalism, theft, malicious mischief, fire, sprinkler leakage, civil authority, sonic boom, explosion, collapse, flood including tidal wave (however, for projects not solely funded through revenue bonds, Contractor is only required to provide insurance for damages caused by a tidal wave up to 5% of the Contract Sum [except as provided in Section 11.1.6.2, below; see Public Contract Code §7105(a)], earthquake (however, for projects not solely funded through revenue bonds, Contractor is only required to provide insurance for damages caused by an earthquake above 3.5 magnitude on the Richter Scale up to 5% of the Contract Sum [except as provided in

Section 11.1.6.3, below; see Public Contract Code §7105(a)), wind, hail, lightning, smoke, riot or civil commotion, debris removal (including demolition) and reasonable compensation for the Architect's services and expenses required as a result of such insured loss. This insurance shall provide coverage in an amount not less than the full cost to repair, replace or reconstruct the Work. Such insurance shall include the Owner, the Architect, and any other person or entity with an insurable interest in the Work as an additional named insured.

The Contractor shall submit to the Owner for its approval all items deemed to be uninsurable under the Builder's Risk/Course-of-Construction insurance. The risk of the damage to the Work due to the perils covered by the Builder's Risk/Course-of-Construction insurance, as well as any other hazard which might result in damage to the Work, is that of the Contractor and the surety, and no claims for such loss or damage shall be recognized by the Owner, nor will such loss or damage excuse the Complete and satisfactory performance of the Contract by the Contractor.

#### 11.1.6.2 TIDAL WAVE INSURANCE

If the Contract is not solely funded through revenue bonds and Owner accepts an alternate bid by Contractor for insurance coverage for a tidal wave, Contractor shall maintain, in effect during the Work and until final acceptance of the Work by Owner upon Completion of the entire Contract, insurance providing coverage for loss, destruction or damage arising out of or caused by tidal wave and other similar acts of God. This insurance shall provide coverage in an amount not less than the full cost to repair, replace or reconstruct the Work.

#### 11.1.6.3 EARTHQUAKE INSURANCE

If the Contract is not solely funded through revenue bonds and Owner accepts an alternate bid by Contractor for insurance coverage for an earthquake over 3.5 on the Richter Scale, Contractor shall maintain, in effect during the Work and until final acceptance of the Work by Owner upon Completion of the entire Contract, insurance providing coverage for loss, destruction or damage arising out of or caused by earthquake and/or other earth movement, whether seismic or volcanic in origin, over 3.5 on the Richter Scale in magnitude. This insurance shall provide coverage in an amount not less than the full cost to repair, replace or reconstruct the Work.

#### 11.1.7 CONSENT OF INSURER FOR PARTIAL OCCUPANCY OR USE

Partial occupancy or use in accordance with the Contract Documents shall not commence until the insurance company providing property insurance has consented to such partial occupancy or use by endorsement or otherwise. The Owner and the Contractor shall take reasonable steps to obtain consent of the insurance company and shall, without mutual consent, take no action with respect to partial occupancy or use that would cause cancellation, lapse, or reduction of the insurance.

#### 11.1.8 FIRE INSURANCE

Before the commencement of the Work, the Contractor shall procure, maintain, and cause to be maintained at the Contractor's expense, fire insurance on all Work included under the Contract

Documents, insuring the full replacement value of such Work as well as the cost of any removal and demolition necessary to replace or repair all Work damaged by fire. The amount of fire insurance shall be subject to approval by the Owner and shall be sufficient to protect the Work against loss or damage in full until the Work is accepted by the Owner. Should the Work being constructed be damaged by fire or other causes during construction, it shall be replaced in accordance with the requirements of the drawings and specifications without additional expense to the Owner.

#### **11.1.9 OTHER INSURANCE**

The Contractor shall provide all other insurance required to be maintained under applicable laws, ordinances, rules, and regulations.

#### **11.1.10 PROOF OF CARRIAGE OF INSURANCE**

The Contractor shall not commence Work nor shall it allow any Subcontractor to commence Work under this Contract until all required insurance, certificates, and an Additional Insured Endorsement and Declarations Page have been obtained and delivered in duplicate to the Owner for approval subject to the following requirements:

- (a) Certificates and insurance policies shall include the following clause:

This policy shall not be non-renewed, canceled, or reduced in required limits of liability or amounts of insurance until notice has been mailed to the Owner. Date of cancellation or reduction may not be less than thirty (30) days after the date of mailing notice.

- (b) Certificates of insurance shall state in particular those insured, the extent of insurance, location and operation to which the insurance applies, the expiration date, and cancellation and reduction notices.
- (c) Certificates of insurance shall clearly state that the Owner and the Architect are named as additional insureds under the policy described and that such insurance policy shall be primary to any insurance or self-insurance maintained by Owner and any other insurance carried by the Owner with respect to the matters covered by such policy shall be excess and non-contributing.
- (d) The Contractor and its Subcontractors shall produce a certified copy of any insurance policy required under this Section upon written request of the Owner.

#### **11.1.11 COMPLIANCE**

In the event of the failure of any contractor to furnish and maintain any insurance required by this Article, the Contractor shall be in default under the Contract. Compliance by Contractor

with the requirement to carry insurance and furnish certificates, policies, Additional Insured Endorsement and Declarations Page evidencing the same shall not relieve the Contractor from liability assumed under any provision of the Contract Documents, including, without limitation, the obligation to defend and indemnify the Owner and the Architect.

## **11.2 PERFORMANCE AND PAYMENT BONDS**

### **11.2.1 BOND REQUIREMENTS**

Unless otherwise specified in the Contract Documents, prior to commencing any portion of the Work, the Contractor shall apply for and furnish Owner separate payment and performance bonds for its portion of the Work which shall cover 100% faithful performance of and payment of all obligations arising under the Contract Documents and/or guaranteeing the payment in full of all claims for labor performed and materials supplied for the Work. All bonds shall be provided by a corporate surety authorized and admitted to transact business in California. All bonds shall be submitted on the Owner's approved form.

To the extent, if any, that the Contract Sum is increased in accordance with the Contract Documents, the Contractor shall cause the amount of the bonds to be increased accordingly and shall promptly deliver satisfactory evidence of such increase to the Owner. To the extent available, the bonds shall further provide that no change or alteration of the Contract Documents (including, without limitation, an increase in the Contract Sum, as referred to above), extensions of time, or modifications of the time, terms, or conditions of payment to the Contractor will release the surety. If the Contractor fails to furnish the required bond, the Owner may terminate the Contract for cause.

### **11.2.2 SURETY QUALIFICATION**

Only bonds executed by admitted Surety insurers as defined in Code of Civil Procedure section 995.120 shall be accepted. The surety insurers must, unless otherwise agreed to by Owner in writing, at the time of issuance of the bonds, have a rating not lower than "A-" as rated by A.M. Best Company, Inc. or other independent rating companies. Owner reserves the right to approve or reject the surety insurers selected by Contractor and to require Contractor to obtain bonds from surety insurers satisfactory to the Owner.

## **ARTICLE 12**

### **UNCOVERING AND CORRECTION OF WORK**

#### **12.1 UNCOVERING OF WORK**

##### **12.1.1 UNCOVERING WORK FOR REQUIRED INSPECTIONS**

If a portion of the Work is covered contrary to the Owner's request or to requirements specifically expressed in the Contract Documents, Contractor must, if required in writing by the Owner, uncover it for the Owner's observation and replace the removed work at the Contractor's



expense without change in the Contract Sum or Time.

#### **12.1.2 COSTS FOR INSPECTIONS NOT REQUIRED**

If a portion of the Work has been covered which the Owner has not specifically requested to observe prior to its being covered, the Owner may request to see such work, and it shall be uncovered by the Contractor. If such work is in accordance with the Contract Documents, costs of uncover and replacement shall, by appropriate Change Order, be paid by the Owner. If such work is not in accordance with Contract Documents, the Contractor shall pay such costs, unless the condition was caused by the Owner or a separate contractor, in which event the Owner shall be responsible for payment of such costs to the Contractor.

### **12.2 CORRECTION OF WORK; WARRANTY**

#### **12.2.1 CORRECTION OF REJECTED WORK**

The Contractor shall promptly correct the work rejected by the Owner for failing to conform to the requirements of the Contract Documents, until the statutes of limitation (or repose) and all warranties have run, as applicable, and whether or not fabricated, installed or completed. The Contractor shall bear costs of correcting the rejected work, including additional testing, inspections, and compensation for the Owner's expenses and costs incurred.

#### **12.2.2 REMOVAL OF NONCONFORMING WORK**

The Contractor shall remove from the Site portions of the Work which are not in accordance with the requirements of the Contract Documents and are not corrected by the Contractor or accepted or approved by the Owner.

#### **12.2.3 OWNER'S RIGHTS IF CONTRACTOR FAILS TO CORRECT**

If the Contractor fails to correct nonconforming work within a reasonable time, the Owner may correct it in accordance with Section 2.4. As part of Owner's correction of the work, the Owner may remove any portion of the nonconforming Work and store any salvageable materials or equipment at the Contractor's expense. If the Contractor does not pay costs of such removal and storage within ten (10) days after written notice, the Owner may upon ten (10) additional days written notice sell such material or equipment at auction or at private sale and shall account for the proceeds thereof, after deducting costs and damages that should have been borne by the Contractor, including compensation for the Architect's and other professionals and representatives' services and expenses, made necessary thereby. If such proceeds of sale do not cover costs which the Contractor should have borne, the Contractor shall be invoiced for the deficiency or Owner may withhold such costs from payment pursuant to Section 9.5. If progress payments or retention then or thereafter due the Contractor are not sufficient to cover such amount, the Contractor shall pay the difference to the Owner.

#### **12.2.4 COST OF CORRECTING THE WORK**

The Contractor shall bear the cost of correcting destroyed or damaged construction of the Owner or separate contractors, whether completed or partially completed, caused by the Contractor's correction or removal of the nonconforming work.

#### **12.2.5 WARRANTY CORRECTIONS (INCLUDES REPLACEMENT)**

Pursuant to the warranty in Sections 3.5 and 9.7.1, if within one (1) year after the Completion of the Work or within a longer time period for an applicable special warranty or guarantee required by the Contract Documents, any of the Work does not comply with the Contract Documents, the Contractor shall correct it after receipt of Owner's written notice to do so, unless the Owner has previously waived in writing such right to demand correction. Contractor shall correct the Work promptly, and passage of the applicable warranty period shall not release Contractor from its obligation to correct the Work if Owner provided the written notice within the applicable warranty period. Contractor's obligation to correct the warranty item continues until the correction is made. After the correction is made to Owner's satisfaction, a new warranty period of the same length as the original warranty period shall run on the corrected work. The obligations under this paragraph 12.2.5 shall survive acceptance of the Work under the Contract and termination of the Contract.

#### **12.2.6 NO TIME LIMITATION**

Nothing contained in this Section 12.2 shall be construed to establish a period of limitation with respect to other obligations which the Contractor might have under the Contract Documents. Establishment of the time period of one (1) year as described in Sections 3.5, 9.7.1, and 12.2.5 relates only to the specific warranty obligation of the Contractor to correct the Work after the date of commencement of warranties, and has, for example, no relationship to the time within which the obligation to comply with the Contract Documents may be sought to be enforced, or to the time within which proceedings may be commenced to establish the Contractor's liability with respect to the Contractor's obligations under the Contract Documents.

#### **12.3 NONCONFORMING WORK AND WITHHOLDING THE VALUE OF IT**

If it is found at any time before Completion of the Work that the Contractor has varied from the Contract Documents in materials, quality, form, finish, or in the amount or value of the materials or labor used, the Owner may, in addition to other remedies in the Contract Documents or under law and as allowed by law, accept the improper Work. The Owner may withhold from any amount due or to become due Contractor that sum of money equivalent to the difference in value between the Work performed and that called for by the Drawings and Specifications. The Owner shall determine such difference in value. No structural-related Work shall be accepted that is not in conformance with the Contract Documents.

## **ARTICLE 13**

### **MISCELLANEOUS PROVISIONS**

#### **13.1 GOVERNING LAW**

The Contract shall be governed by the law of the place where the Project is located.

#### **13.2 SUCCESSORS AND ASSIGNS**

The Owner and the Contractor respectively bind themselves, their partners, successors, assigns, and legal representatives to the other party hereto and to partners, successors, assigns, and legal representatives of such other party in respect to covenants, agreements, and obligations contained in the Contract Documents. Neither party to the Contract shall assign the Contract as a whole or in part without written consent of the other. If either party attempts to make such an assignment without such consent, that party shall nevertheless remain legally responsible for all obligations under the Contract.

#### **13.3 WRITTEN NOTICE**

In the absence of specific notice requirements in the Contract Documents, any written notice required by the Contract Documents shall be deemed to have been duly served if delivered in person to the individual, member of the firm or entity, or to an officer of the corporation for which it was intended, or if delivered at or sent by registered or certified or overnight mail to the last business address known to the party giving notice. Owner shall, at Contractor's cost, timely notify Contractor of Owner's receipt of any third party claims relating to the Contract pursuant to Public Contract Code section 9201.

#### **13.4 RIGHTS AND REMEDIES**

##### **13.4.1 DUTIES AND OBLIGATIONS CUMULATIVE**

Duties and obligations imposed by the Contract Documents and rights and remedies available thereunder shall be in addition to and not a limitation of duties, obligations, rights, and remedies otherwise imposed or available by law.

##### **13.4.2 NO WAIVER**

No action or failure to act by the Owner, Inspector of Record, Architect or any construction manager shall constitute a waiver of a right or duty afforded them under the Contract Documents, nor shall such action or failure to act constitute approval of or acquiescence in a breach thereunder, except as may be specifically agreed to in a written amendment to the Contract.

## **13.5 TESTS AND INSPECTIONS**

### **13.5.1 COMPLIANCE**

Tests, inspections, and approvals of portions of the Work required by the Contract Documents will comply with Title 24, and with all other laws, ordinances, rules, regulations, or orders of public authorities having jurisdiction.

### **13.5.2 INDEPENDENT TESTING LABORATORY**

The Owner will select and pay an independent testing laboratory to conduct all tests and inspections, including shipping or transportation costs or expenses (mileage and hours). Selection of the materials required to be tested shall be made by the laboratory and not by the Contractor. However, if Contractor requests that the Owner use a different testing laboratory and Owner chooses to approve such request, Contractor shall reimburse the Owner for any additional shipping or transportation costs or expenses (mileage and hours). Owner may invoice such costs or expenses to the Contractor or withhold such costs or expenses from progress payments and/or retention.

### **13.5.3 ADVANCE NOTICE TO INSPECTOR OF RECORD**

The Contractor shall notify the Inspector of Record a sufficient time in advance of its readiness for required observation or inspection so that the Inspector of Record may arrange for same. The Contractor shall notify the Inspector of Record a sufficient time in advance of the manufacture of material to be supplied under the Contract Documents which must, by terms of the Contract Documents, be tested in order that the Inspector of Record may arrange for the testing of the material at the source of supply.

### **13.5.4 TESTING OFF-SITE**

Any material shipped by the Contractor from the source of supply, prior to having satisfactorily passed such testing and inspection or prior to the receipt of notice from said Inspector of Record that such testing and inspection will not be required, shall not be incorporated in the Work.

### **13.5.5 ADDITIONAL TESTING OR INSPECTION**

If the Inspector of Record, the Architect, the Owner, or public authority having jurisdiction determines that portions of the Work require additional testing, inspection, or approval not included under section 13.5.1, the Inspector of Record will, upon written authorization from the Owner, make arrangements for such additional testing, inspection, or approval. The Owner shall bear such costs except as provided in section 13.5.6.

### **13.5.6 COSTS FOR RETESTING**

If such procedures for testing, inspection, or approval under sections 13.5.1, 13.5.2 and 13.5.5 reveal failure of the portions of the Work to comply with requirements established by the

Contract Documents, the Contractor shall bear all costs arising from such failure, including those of re-testing, re-inspection, or re-approval, including, but not limited to, compensation for the Architect's services and expenses. Any such costs shall be paid by the Owner, invoiced to the Contractor, and, among other remedies, can be withheld from progress payments and/or retention.

#### **13.5.7 COSTS FOR PREMATURE TEST**

In the event the Contractor requests any test or inspection for the Project and is not completely ready for the inspection, the Contractor shall be invoiced by the Owner for all costs and expenses resulting from that testing or inspection, including, but not limited to, the Architect's fees and expenses, and the amount of the invoice can among other remedies, be withheld from progress payments and/or retention.

#### **13.5.8 TESTS OR INSPECTIONS NOT TO DELAY WORK**

Tests or inspections conducted pursuant to the Contract Documents shall be made promptly to avoid unreasonable delay in the Work.

#### **13.6 [INTENTIONALLY LEFT BLANK]**

#### **13.7 TRENCH EXCAVATION**

##### **13.7.1 TRENCHES GREATER THAN FIVE FEET**

Pursuant to Labor Code section 6705, if the Contract Sum exceeds \$25,000 and involves the excavation of any trench or trenches five (5) feet or more in depth, the Contractor shall, in advance of excavation, submit to the Owner or a registered civil or structural engineer employed by the Owner a detailed plan showing the design of shoring for protection from the hazard of caving ground during the excavation of such trench or trenches.

##### **13.7.2 EXCAVATION SAFETY**

If such plan varies from the Shoring System Standards established by the Construction Safety Orders, the plan shall be prepared by a registered civil or structural engineer, but in no case shall such plan be less effective than that required by the Construction Safety Orders. No excavation of such trench or trenches shall be commenced until said plan has been accepted by the Owner or by the person to whom authority to accept has been delegated by the Owner.

##### **13.7.3 NO TORT LIABILITY OF OWNER**

Pursuant to Labor Code section 6705, nothing in this Article shall impose tort liability upon the Owner or any of its employees.

#### **13.7.4 NO EXCAVATION WITHOUT PERMITS**

The Contractor shall not commence any excavation work until it has secured all necessary permits including the required CAL OSHA excavation/shoring permit. Any permits shall be prominently displayed on the Site prior to the commencement of any excavation.

### **13.8 WAGE RATES**

#### **13.8.1 WAGE RATES**

Pursuant to the provisions of Article 2 (commencing at § 1770), Chapter 1, Part 7, Division 2, of the Labor Code, the governing board of the Owner has obtained the general prevailing rate of per diem wages and the general prevailing rate for holiday and overtime work in the locality in which this public work is to be performed for each craft, classification, or type of worker needed for this Project from the Director of Industrial Relations (“Director”). These rates are on file with the Clerk of the Owner’s governing board, and copies will be made available to any interested party on request. The Contractor shall post a copy of such wage rates at the Site.

#### **13.8.2 HOLIDAY AND OVERTIME PAY**

Holiday and overtime work, when permitted by law, shall be paid for at a rate of at least one and one-half (1½) times the above specified rate of per diem wages, unless otherwise specified. Holidays shall be defined in the Collective Bargaining Agreement applicable to each particular craft, classification, or type of worker employed.

#### **13.8.3 WAGE RATES NOT AFFECTED BY SUBCONTRACTS**

The Contractor shall pay and shall cause to be paid each worker engaged in the Work not less than the general prevailing rate of per diem wages determined by the Director, regardless of any contractual relationship which may be alleged to exist between the Contractor or any Subcontractor and such workers.

#### **13.8.4 CHANGE IN PREVAILING WAGE DURING BID OR CONSTRUCTION**

If during the period this bid is required to remain open, the Director of Industrial Relations determines that there has been a change in any prevailing rate of per diem wages in the locality in which this public work is to be performed, such change shall not alter the wage rates discussed in the Notice to Bidders or the Contract subsequently awarded.

#### **13.8.5 FORFEITURE AND PAYMENTS**

Pursuant to Labor Code section 1775, the Contractor and any subcontractor under the Contractor shall as a penalty to the Owner, forfeit not more than Two Hundred Dollars (\$200.00) for each calendar day, or portion thereof, for each worker paid less than the prevailing rate of per diem wages, determined by the Director, for such craft or classification in which such worker is employed for any public work done under the Agreement by the Contractor or by any

Subcontractor under it. Minimum penalties shall apply, as also provided in Civil Code section 1775. The amount of the penalty shall be determined by the Labor Commissioner and shall be based on both of the following: (1) whether the failure of the contractor or subcontractor to pay the correct rate of per diem wages was a good faith mistake and, if so, the error was promptly and voluntarily corrected upon being brought to the attention of the contractor or subcontractor; and (2) whether the contractor or subcontractor has a prior record of failing to meet its prevailing wage obligations. The difference between such prevailing rate of per diem wage and the amount paid to each worker for each calendar day or portion thereof for which each worker was paid less than the prevailing rate of per diem wage shall be paid to each work by the Contractor or subcontractor. Labor Code section 1777.1 shall also apply.

### **13.8.6 MINIMUM WAGE RATES**

Any worker employed to perform Work, which Work is not covered by any craft or classification listed in the general prevailing rate of per diem wages determined by the Director, shall be paid not less than the minimum rate of wages specified therein for the craft or classification which most nearly corresponds to the Work to be performed by them, and such minimum wage rate shall be retroactive to time of initial employment of such person in such craft or classification.

### **13.8.7 PER DIEM WAGES**

Pursuant to Labor Code section 1773.1, per diem wages includes employer payments for health and welfare, pension, and vacation pay.

### **13.8.8 POSTING OF WAGE RATES AND OTHER REQUIRED JOB SITE NOTICES**

The Contractor shall post at appropriate conspicuous points on the Site, a schedule showing all determined minimum wage rates and all authorized deductions, if any, from unpaid wages actually earned and all other required job site notices as prescribed by regulation.

## **13.9 RECORD OF WAGES PAID: INSPECTION**

### **13.9.1 APPLICATION OF LABOR CODE**

Pursuant to section 1776 of the Labor Code:

(a) Each Contractor and subcontractor shall keep accurate payroll records, showing the name, address, social security number, work classification, and straight time and overtime hours worked each day and week, and the actual per diem wages paid to each journeyman, apprentice, worker, or other employee employed by him or her in connection with the public work. Each payroll record shall contain or be verified by a written declaration that is made under penalty of perjury, stating both of the following:

- (1) The information contained in the payroll record is true and correct.
- (2) The employer has complied with the requirements of sections 1771, 1811

and 1815 for any work performed by his or her employees on the public works project.

(b) The payroll records enumerated under subdivision (a) shall be certified and shall be available for inspection at all reasonable hours at the principal office of the Contractor on the following basis:

(1) A certified copy of an employee's payroll record shall be made available for inspection or furnished to the employee or his or her authorized representative on request.

(2) A certified copy of all payroll records enumerated in subdivision (a) shall be made available for inspection or furnished upon request to a representative of the Owner and the Division of Labor Standards Enforcement of the Department of Industrial Relations ("DIR") and as may be required by the Labor Commissioner under Labor Code section 1771.4. The Contractor and each subcontractor shall furnish a certified copy of all payroll records directly to the Labor Commissioner monthly or more frequently, if so specified in the Agreement and in a format the Labor Commissioner prescribes.

(3) A certified copy of all payroll records enumerated in subdivision (a) shall be made available upon request by the public for inspection or for copies thereof. However, a request by the public shall be made through either the body awarding the contract or the Division of Labor Standards Enforcement of the DIR. If the requested payroll records have not been provided pursuant to paragraph (2), the requesting party shall, prior to being provided the records, reimburse the costs of the preparation by the contractor, subcontractors, and the entity through which the request was made. The public may not be given access to such records at the principal office of the Contractor.

(c) Unless required as of January 1, 2015, to be furnished directly to the Labor Commissioner under Labor Code section 1771.4(a)(3), the certified payroll records shall be on forms provided by the Division of Labor Standards Enforcement of the DIR or shall contain the same information as the forms provided by the division. The payroll records may consist of printouts of payroll data that are maintained as computer records, if the printouts contain the same information as the forms provided by the division and the printouts are verified in the manner specified in (a) above.

(d) A Contractor or subcontractor shall file a certified copy of the records enumerated in subdivision (a) with the entity that requested such records within 10 days after receipt of a written request.

(e) Except as provided in subdivision (f), any copy of records made available for inspection as copies and furnished upon request to the public or any public agency by the awarding body or the Division of Labor Standards Enforcement of the DIR shall be marked or obliterated to prevent disclosure of an individual's name, address and social security number. The name and address of the Contractor awarded the Contract or the



subcontractor performing the Contract shall not be marked or obliterated. Any copy of records made available for inspection by, or furnished to, a multiemployer Taft-Hartley trust fund (29 U.S.C. Sec. 186(c)(5) that requests the records for the purposes of allocating contributions to participants shall be marked or obliterated only to prevent disclosure of an individual's full social security number, but shall provide the last four digits of the social security number. Any copy of records made available for inspection by, or furnished to, a joint labor-management committee established pursuant to the federal Labor Management Cooperation Act of 1978 (29 U.S.C. Sec. 175a) shall be marked or obliterated only to prevent disclosure of an individual's social security number.

(f) Notwithstanding any other provision of law, agencies that are included in the Joint Enforcement Strike Force on the Underground Economy established pursuant to Section 329 of the Unemployment Insurance Code and other law enforcement agencies investigating violations of law shall, upon request, be provided nonredacted copies of certified payroll records. Any copies of records or certified payroll made available for inspection and furnished upon request to the public by an agency included in the Joint Enforcement Strike Force on the Underground Economy or to a law enforcement agency investigating a violation of law shall be marked or redacted to prevent disclosure of an individual's name, address, and social security number. An employer shall not be liable for damages in a civil action for any reasonable act or omission taken in good faith in compliance with this subsection.

(g) The contractor shall inform the body awarding the contract of the location of the records enumerated under subdivision (a), including the street address, city and county, and shall, within five working days, provide a notice of a change of location and address.

(h) The contractor or subcontractor has 10 days in which to comply subsequent to receipt of written notice requesting the records enumerated in subdivision (a). In the event that the Contractor or subcontractor fails to comply within the 10-day period, he or she shall, as a penalty to the state or political subdivision on whose behalf the contract is made or awarded, forfeit One Hundred Dollars (\$100.00) for each calendar day, or portion thereof, for each worker, until strict compliance is effectuated. Upon the request of the Division of Labor Standards Enforcement of the DIR, these penalties shall be withheld from progress payments then due. A contractor is not subject to a penalty assessment pursuant to this section due to the failure of the subcontractor to comply with this section.

## 13.10 APPRENTICES

### 13.10.1 APPRENTICE WAGES AND DEFINITIONS

All apprentices employed by the Contractor to perform services under the Contract shall be paid the standard wage paid to apprentices under the regulations of the craft or trade at which he or she is employed, and shall be employed only at the work of the craft or trade to which he or she

is registered. Only apprentices, as defined in section 3077 of the Labor Code, who are in training under apprenticeship standards and written apprenticeship agreements under Chapter 4 (commencing with § 3070) of Division 3, are eligible to be employed under this Contract. The employment and training of each apprentice shall be in accordance with the apprenticeship standards and apprentice agreements under which he or she is training. Contractor shall pay apprentices for any preemployment activities, as set forth in Labor Code section 1777.5.

### **13.10.2 APPRENTICE LABOR POOL**

When the Contractor to whom the Contract is awarded by the Owner, or any Subcontractor under him or her, in performing any of the Work under the Contract or subcontract, employs workers in any apprenticeable craft or trade, the Contractor and Subcontractor shall apply to the joint apprenticeship committee administering the apprenticeship standards of the craft or trade in the area of the Site of the Project, for a certificate approving the Contractor or Subcontractor under the apprenticeship standards for the employment and training of apprentices in the area or industry affected. However, approval as established by the joint apprenticeship committee or committees shall be subject to the approval of the Administrator of Apprenticeship. The joint apprenticeship committee or committees, subsequent to approving the subject Contractor or Subcontractor, shall arrange for the dispatch of apprentices to the Contractor or Subcontractor in order to comply with this section. Every Contractor and Subcontractor shall submit the contract award information to the applicable joint apprenticeship committee which shall include an estimate of journeyman hours to be performed under the Contract, the number of apprentices to be employed, and the approximate dates the apprentices will be employed. There shall be an affirmative duty upon the joint apprenticeship committee or committees administering the apprenticeship standards of the crafts or trade in the area of the Site of the public work, to ensure equal employment and affirmative action and apprenticeship for women and minorities. Contractors or Subcontractors shall not be required to submit individual applications for approval to local joint apprenticeship committees provided they are already covered by the local apprenticeship standards. The ratio of work performed by apprentices to journeymen, who shall be employed in the craft or trade on the Project, may be the ratio stipulated in the apprenticeship standards under which the joint apprenticeship committee operates, but, except as otherwise provided in this section, in no case shall the ratio be less than one (1) hour of apprentice work for every five (5) hours of labor performed by a journeyman. However, the minimum ratio for the land surveyor classification shall not be less than one (1) apprentice for each five (5) journeymen.

### **13.10.3 JOURNEYMAN/APPRENTICE RATIO; COMPUTATION OF HOURS**

Any ratio shall apply during any day or portion of a day when any journeyman, or the higher standard stipulated by the joint apprenticeship committee, is employed at the job Site and shall be computed on the basis of the hours worked during the day by journeymen so employed, except for the land surveyor classification. The Contractor shall employ apprentices for the number of hours computed as above before the end of the Contract. However, the Contractor shall endeavor, to the greatest extent possible, to employ apprentices during the same time period that the journeymen in the same craft or trade are employed at the job Site. Where an hourly apprenticeship ratio is not feasible for a particular craft or trade, the Division of Apprenticeship

Standards, upon application of a joint apprenticeship committee, may order a minimum ratio of not less than one (1) apprentice for each five (5) journeymen in a craft or trade classification.

#### 13.10.4 JOURNEYMAN/APPRENTICE RATIO

The Contractor or Subcontractor, if he or she is covered by this section upon the issuance of the approval certificate, or if he or she has been previously approved in the craft or trade, shall employ the number of apprentices or the ratio of apprentices to journeymen stipulated in the apprenticeship standards. Upon proper showing by the Contractor that he or she employs apprentices in the craft or trade in the state on all of his or her contracts on an annual average of not less than one (1) hour of apprentice work for every five (5) hours of labor performed by a journeyman, or in the land surveyor classification, one (1) apprentice for each five (5) journeymen, the Division of Apprenticeship Standards may grant a certificate exempting the Contractor from the 1-to-5 hourly ratio as set forth in this section. This section shall not apply to contracts of general contractors or to contracts of specialty contractors not bidding for work through a general or prime contractor, when the contracts of general contractors or those specialty contractors involve less than Thirty Thousand Dollars (\$30,000) or twenty (20) working days. Any work performed by a journeyman in excess of eight (8) hours per day or forty (40) hours per week, shall not be used to calculate the hourly ratio required by this section.

13.10.4.1 *Apprenticeable Craft or Trade.* “Apprenticeable craft or trade” as used in this Article means a craft or trade determined as an apprenticeable occupation in accordance with the rules and regulations prescribed by the California Apprenticeship Council. The joint apprenticeship committee shall have the discretion to grant a certificate, which shall be subject to the approval of the Administrator of Apprenticeship, exempting a Contractor from the 1-to-5 ratio set forth in this Article when it finds that any one of the following conditions is met:

- A. Unemployment for the previous three-month period in the area exceeds an average of fifteen percent (15%).
- B. The number of apprentices in training in such area exceeds a ratio of 1-to-5.
- C. There is a showing that the apprenticeable craft or trade is replacing at least one-thirtieth (1/30) of its journeymen annually through the apprenticeship training, either on a statewide basis or on a local basis.
- D. Assignment of an apprentice to any work performed under this contract would create a condition which would jeopardize his or her life or the life, safety, or property of fellow employees or the public at large or if the specific task to which the apprentice is to be assigned is of such a nature that training cannot be provided by a journeyman.

#### 13.10.5 RATIO EXEMPTION

When exemptions are granted to an organization which represents Contractors in a specific trade from the 1-to-5 ratio on a local or statewide basis, the member Contractors will not be required to

submit individual applications for approval to local joint apprenticeship committees, if they are already covered by the local apprenticeship standards.

#### **13.10.6 APPRENTICE FUND**

A Contractor to whom the Contract is awarded or any Subcontractor under him or her, who, in performing any of the work under the Contract, employs journeymen or apprentices in any apprenticeable craft or trade and who is not contributing to a fund or funds to administer and conduct the apprenticeship program in any such craft or trade in the area of the Site of the Project, to which fund or funds other contractors in the area of the Site of the Project are contributing, shall contribute to the fund or funds in each craft or trade in which he or she employs journeymen or apprentices on the Project in the same amount or upon the same basis and in the same manner as the other contractors do, but where the trust fund administrators are unable to accept the funds, contractors not signatory to the trust agreement shall pay a like amount to the California Apprenticeship Council. The Contractor or Subcontractor may add the amount of the contributions in computing his or her bid for the contract. The Division of Labor Standards Enforcement is authorized to enforce the payment of the contributions to the fund or funds as set forth in the Labor Code section 227.

#### **13.10.7 PRIME CONTRACTOR COMPLIANCE**

The responsibility of compliance with section 13.10 and section 1777.5 of the Labor Code for all apprenticeable occupations is with the Contractor.

#### **13.10.8 DECISIONS OF JOINT APPRENTICESHIP COMMITTEE**

All decisions of the joint apprenticeship committee under this section 13.10 and Labor Code section 1777.5 are subject to Labor Code section 3081.

#### **13.10.9 NO BIAS**

It shall be unlawful for an employer or a labor union to refuse to accept otherwise qualified employees as registered apprentices on any public works on the grounds of race, religious creed, color, national origin, ancestry, sex, or age, except as provided in the Labor Code section 3077.

#### **13.10.10 VIOLATION OF LABOR CODE**

Pursuant to Labor Code sections 1777.1 and 1777.7, in the event a Contractor or Subcontractor fails to comply with the provisions of this section 13.10 and Labor Code section 1777.5, penalties shall apply, including among other things:

- (a) If a Contractor or Subcontractor willfully fails to comply, the Labor Commissioner may deny to the contractor or subcontractor, and to its responsible officers, the right to bid on, or be awarded or perform work as a subcontractor on, any public works project for a period of up to one year for the first violation and for a period of up to three years for the second and subsequent violation. Each period of

debarment shall run from the date the determination of noncompliance by the Labor Commissioner becomes a final order.

(b) A contractor or subcontractor who violates section 1777.5 shall forfeit as a civil penalty an amount not exceeding the sum of One Hundred Dollars (\$100) for each full calendar day of noncompliance. Upon receipt of a determination that a civil penalty has been imposed, the awarding body shall enforce the penalty, which includes withholding the amount of the civil penalty from the contract progress payments or retention then due or to become due.

(c) In lieu of the penalty provided, the Labor Commissioner may for a first time violation and with the concurrence of an applicable apprenticeship program, order the contractor or subcontractor to provide apprentice employment equivalent to the work hours that would have been provided for apprentices during the period of noncompliance.

(d) Any funds withheld by the awarding body pursuant to this section shall be deposited in the General Fund.

(e) The interpretation and enforcement of section 1777.5 and this section shall be in accordance with the regulations of the California Apprenticeship Council.

Pursuant to Public Contract Code section 6109, no contractor or subcontractor may bid on, be awarded, or perform work as a subcontractor on a public works project if ineligible to bid or work on, or be awarded, a public works project pursuant to section 1777.1 of the Labor Code.

## **13.11 ASSIGNMENT OF ANTITRUST CLAIMS**

### **13.11.1 APPLICATION**

Pursuant to Public Contract Code section 7103.5 and Government Code section 4552, in entering into a public works contract or a subcontract to supply goods, services, or materials pursuant to a public works contract, the Contractor or Subcontractor offers and agrees to assign to the Owner all rights, title, and interest in and to all causes of action it may have under Section 4 of the Clayton Act, (15 U.S.C. § 15) or under the Cartwright Act (Chapter 2 [commencing with § 16700] of Part 2 of Division 7 of the Bus. & Prof. Code), arising from the purchase of goods, services, or materials pursuant to the public works contract or the subcontract. This assignment shall be made and become effective at the time the awarding body tenders Final Progress Payment to the Contractor, without further acknowledgment by the parties. If the Owner receives, either through judgment or settlement, a monetary recovery for a cause of action assigned under Chapter 11 (commencing with § 4550) of Division 5 of Title 1 of the Government Code, the assignor may, upon demand, recover from the Owner any portion of the recovery, including treble damages, attributable to overcharges that were paid by the assignor but were not paid by the Owner as part of the bid price, less the expenses incurred in obtaining that portion of the recovery.

### 13.11.2 ASSIGNMENT OF CLAIM

Upon demand in writing by the assignor, the Owner shall, within one (1) year from such demand, reassign the cause of action assigned pursuant to this Article if the assignor has been or may have been injured by the violation of law for which the cause of action arose and the Owner has not been injured thereby or the Owner declines to file a court action for the cause of action.

### 13.12 AUDIT

Pursuant to and in accordance with the provisions of Government Code section 8546.7, or any amendments thereto, all books, records, and files of the Owner, the Contractor, or any Subcontractor connected with the performance of this Contract involving the expenditure of state funds in excess of Ten Thousand Dollars (\$10,000.00), including, but not limited to, the administration thereof, shall be subject to the examination and audit of the Office of the Auditor General of the State of California for a period of three (3) years after release of all retention under this Contract. Contractor shall preserve and cause to be preserved such books, records, and files for the audit period. During the progress of the Work and for three (3) years after Completion of the Work, Owner shall also have the right to an audit of all of Contractor's books, records, subcontracts, material and equipment contracts, files, and information related to the Contract, and Contractor must cooperate by producing all requested items within seven (7) days.

### 13.13 STORM WATER DISCHARGE PERMIT

If applicable, the Contractor shall file a Notice of Intent to comply with the terms of the general permit to discharge storm water associated with construction activity (WQ Order No. 920-08-DWQ). The Notice of Intent must be sent to the following address along with the appropriate payment (warrant to be furnished by the Owner upon request by the Contractor, allow warrant processing time.): California State Water Resources Control Board, Division of Water Quality, Storm Water Permit Unit, P.O. Box 1977, Sacramento, CA 95812-1977. The Contractor may also call the State Water Board's Construction Activity Storm Water Hotline at (916) 657-1146. The Notice of Intent shall be filed prior to the start of any construction activity.

## ARTICLE 14

### TERMINATION OR SUSPENSION OF THE CONTRACT

#### 14.1 TERMINATION BY THE CONTRACTOR FOR CAUSE

Contractor may not terminate performance for convenience. Contractor may only terminate performance for cause if the Work is stopped by others for a period of one hundred eighty (180) consecutive days through no act or fault of the Contractor, a Subcontractor of any tier, their agents or employees, or any other persons performing portions of the Work for whom the Contractor is contractually responsible, **and** the Work was stopped by others for one of the following reasons: (A) Issuance of an order of a court or other public authority having jurisdiction which requires Owner to stop all Work; or (B) an act of government, such as a declaration of national emergency, making material unavailable which requires Owner to stop all

Work. If such grounds exist, the Contractor may serve written notice of such grounds on Owner and demand a meet-and-confer conference to negotiate a resolution in good faith within twenty (20) days of Owner's receipt of such notice. If such conference does not lead to resolution and the grounds for termination still exist, Contractor may terminate the Contract and recover from the Owner payment for Work executed and for reasonable verified costs with respect to materials, equipment, tools, construction equipment, and machinery, including reasonable overhead, profit, and damages for the Work executed, but excluding overhead (field and home office) and profit for (i) Work not performed and (ii) the period of time that the Work was stopped.

## 14.2 TERMINATION BY THE OWNER FOR CAUSE

### 14.2.1 GROUNDS FOR TERMINATION

The Owner may terminate performance of the Contract if the Contractor:

- A. Refuses or fails to supply enough properly skilled workers or proper materials, or refuses or fails to take steps to adequately prosecute the Work to meet a Milestone Deadline or to Complete within the Contract Time;
- B. Fails to make payment to Subcontractors for materials or labor in accordance with Public Contract Code section 10262 or Business and Professions Code section 7108.5, as applicable;
- C. Violates Labor Code section 1771.1(a), subject to the provisions of Labor Code section 1771.1(f);
- D. Disregards laws, ordinances, rules, regulations, or orders of a public authority having jurisdiction; or
- E. Otherwise is in breach of the Contract Documents.

### 14.2.2 NOTIFICATION OF TERMINATION

When any of the above reasons exist, the Owner may, without prejudice to any other rights or remedies of the Owner, give notice to Contractor of the grounds for termination and demand cure of the grounds within seven (7) days (a "Notice of Intent to Terminate"). If Contractor fails to **either** (a) completely cure the grounds for termination within seven (7) days **or** (b) reasonably commence cure of the grounds for termination within seven (7) days and reasonably continue to cure the grounds for termination until such cure is complete, then Owner may terminate the performance of Contract effective immediately upon service of written Notice of Termination and may, subject to any prior rights of Contractor's surety on the performance bond ("Surety"):

- A. Take possession of the Site and of all material, equipment, tools, and construction equipment and machinery thereon owned by the Contractor;

- B. Accept assignment of subcontracts pursuant to section 5.4; and
- C. Complete the Work by whatever reasonable method the Owner may deem expedient, including tender of completion to the Surety.

### 14.2.3 PAYMENTS

If the Owner terminates performance of the Contract for one of the reasons stated in section 14.2.1, the Contractor shall not be entitled to receive further payment until the Work is Complete.

If the unpaid balance of the Contract Sum exceeds costs of Completing the Work, including compensation for professional services and expenses made necessary thereby, such excess shall be paid to the Contractor. If such costs exceed the unpaid balance, the Contractor shall pay the difference to the Owner. This payment obligation shall survive Completion of the Work.

### 14.2.4 WRONGFUL TERMINATION

To claim a breach of contract or violation of law based on alleged wrongful termination for cause by the Owner, or if Contractor otherwise seeks any payment or damages related to a termination, within fifteen (15) days of the alleged breach of contract, violation of law, or wrongful termination Contractor shall submit a Claim pursuant and subject to Sections 4.5.3-4.5.6. The Contractor need not submit a Notice of Potential Change or a Change Order Request.

### 14.2.5 INCLUSION OF TERMINATION FOR CONVENIENCE

Any purported termination by Owner for cause under this section 14.2, which is revoked or determined to not have been for cause, shall be deemed to have been a termination for convenience effective as of the same date as the purported termination for cause.

## 14.3 SUSPENSION OR TERMINATION BY THE OWNER FOR CONVENIENCE

### 14.3.1 SUSPENSION BY OWNER

The Owner may, without cause, order the Contractor in writing to suspend, delay, or interrupt the Work in whole or in part for such period of time as the Owner may determine.

14.3.1.1 *Adjustments.* An adjustment shall be made for increases in the cost of performance of the Contract, including profit on the increased cost of performance caused by suspension, delay, or interruption. No adjustment shall be made to the extent:

- A. That performance is, was or would have been so suspended, delayed, or interrupted by another cause for which the Contractor is responsible; or
- B. That an equitable adjustment is made or denied under another provision of this Contract.



14.3.1.2 *Adjustments for Fixed Cost.* Adjustments made in the cost of performance may have a mutually agreed fixed or percentage fee.

#### 14.3.2 TERMINATION BY THE OWNER FOR CONVENIENCE

14.3.2.1 The Owner may, at any time, terminate performance of the Contract for the Owner's convenience and without cause.

14.3.2.2 Upon receipt of written notice from the Owner of such termination for the Owner's convenience, the Contractor shall:

1. Cease operations as directed by the Owner in the notice;
2. Take actions necessary, or that the Owner may direct, for the protection and preservation of the Work; and
3. Except for Work directed to be performed prior to the effective date of termination stated in the notice, terminate all existing subcontracts and purchase orders and enter into no further subcontracts and purchase orders.

14.3.2.3 In case of such termination for the Owner's convenience, the Contractor shall be entitled to receive payment for Work executed, and costs incurred by reason of such termination.

#### 14.4 NOT A WAIVER

Any suspension or termination by Owner of performance by Contractor for convenience or cause under this Article 14 shall not act as a waiver of any claims by Owner against Contractor or others for damages based on breach of contract, negligence or other grounds.

#### 14.5 MUTUAL TERMINATION FOR CONVENIENCE

The Contractor and the Owner may mutually agree in writing to terminate performance of this Contract for convenience. The Contractor shall receive payment for all Work performed to the date of termination in accordance with the provisions of Article 9.

#### 14.6 EARLY TERMINATION

Notwithstanding any provision herein to the contrary, if for any fiscal year of this Contract the governing body of the Owner fails to appropriate or allocate funds for future periodic payments under the Contract after exercising reasonable efforts to do so, the Owner may upon thirty (30) days' notice, order Work on the Project to cease. The Owner will remain obligated to pay for the Work already performed but shall not be obligated to pay the balance remaining unpaid beyond the fiscal period for which funds have been appropriated or allocated and for which the Work has not been done.

**SPECIAL CONDITIONS**  
**DOCUMENT 00 62 01**

In the event of any conflict between the Special Conditions and the General Conditions, the conflict shall be resolved as described in the General Conditions.

**1. Mitigation Measures**

Contractor shall comply with all applicable mitigation measures, if any, adopted by any public agency with respect to this Project pursuant to the California Environmental Quality Act. (Public Resources Code section 21000 *et seq.*)

**2. Modernization Projects**

**2.1 Access.** Access to the school buildings and entry to buildings, classrooms, restrooms, mechanical rooms, electrical rooms, or other rooms, for construction purposes, must be coordinated with District and onsite District personnel before Work is to start. Unless agreed to otherwise in writing, only a school custodian will be allowed to unlock and lock doors in existing building(s). The custodian will be available only while school is in session. If a custodian is required to arrive before 7:00 a.m. or leave after 3:30 p.m. to accommodate Contractor's Work, the overtime wages for the custodian will be paid by the Contractor, unless at the discretion of the District, other arrangements are made in advance.

**2.2 Keys.** Upon request, the District may, at its own discretion, provide keys to the school site for the convenience of the Contractor. The Contractor agrees to pay all expenses to re-key the entire school site and all other affected District buildings if the keys are lost or stolen, or if any unauthorized party obtains a copy of the key or access to the school.

**2.3 Maintaining Services.** The Contractor is advised that Work is to be performed in spaces regularly scheduled for instruction. Interruption and/or periods of shutdown of public access, electrical service, water service, lighting, or other utilities shall be only as arranged in advance with the District. Contractor shall provide temporary services to all facilities interrupted by Contractor's Work.

**2.4 Maintaining Utilities.** The Contractor shall maintain in operation during duration of Contract, drainage lines, storm drains, sewers, water, gas, electrical, steam, and other utility service lines within working area.

**2.5 Confidentiality.** Contractor shall maintain the confidentiality of all information, documents, programs, procedures and all other items that Contractor encounters while performing the Work. This requirement shall be ongoing and shall survive the expiration

or termination of this Contract and specifically includes, without limitation, all student, parent, and employee disciplinary information and health information.

**2.6 Work during Instructional Time.** By submitting its bid, Contractor affirms that Work may be performed during ongoing instruction in existing facilities. If so, Contractor agrees to cooperate to the best of its ability to minimize any disruption to school operations and any use of school facilities by the public up to, and including, rescheduling specific work activities, at no additional cost to District.

**2.7 No Work during Student Testing.** Contractor shall, at no additional cost to the District and at the District's request, coordinate its Work to not disturb District students including, without limitation, not performing any Work when students at the Site are taking State or Federally-required tests.

**3. Badge Policy for Contractors**

All Contractors doing work for the District will provide their workers with identification badges. These badges will be worn by all members of the Contractor's staff who are working in a District facility.

**3.1** Badges must be filled out in full and contain the following information:

**3.1.1** Name of Contractor

**3.1.2** Name of Employee

**3.1.3** Contractor's address and phone number

**3.2** Badges are to be worn when the Contractor or his/her employees are on site and must be visible at all times. Contractors must inform their employees that they are required to allow District employees, the Architect, the Construction Manager, the Program Manager, or the Project Inspector to review the information on the badges upon request.

**3.3** Continued failure to display identification badges as required by this policy may result in the individual being removed from the Project or assessment of fines against the Contractor.

**4. Substitution for Specified Items**

See all requirements for substitutions in the Contract Documents, including but not limited to the General Conditions and Division 01.

**4.1** Whenever in the Specifications any materials, process, or article is indicated or specified by grade, patent, or proprietary name, or by name of manufacturer, that Specification shall be deemed to be followed by the words "or equal." Contractor may,

unless otherwise stated, offer any material, process, or article that shall be substantially equal or better in every respect to that so indicated or specified.

**4.1.1** If the material, process, or article offered by Contractor is not, in the opinion of the District, substantially equal or better in every respect to that specified, then Contractor shall furnish the material, process, or article specified in the Specifications without any additional compensation or change order.

**4.1.2** This provision shall not be applicable with respect to any material, product, thing or service for which District made findings and gave notice in accordance with Public Contract Code section 3400(c); therefore, Contractor shall not be entitled to request a substitution with respect to those materials, products or services.

**4.1.3 Proprietary Systems, Equipment, Materials & Vendors** – Pursuant to Board of Education Resolution No. 2122-0152 in compliance with Public Contract Code §3400(c)(2), Oakland Unified School District designates and approves the following proprietary systems, equipment, materials and vendors for which there are no compatible “or equal” substitutions suggested in any of the technical specification sections

▪ iPhone	IP Series door entry systems
▪ Alerton	Energy Management Systems (EMCS)
▪ Avaya	Phone System, IP-500
▪ BLUM	Casework hinges
▪ Bosch/Radionics	Intrusion System, B9512G
▪ Chicago	Faucets
▪ Cisco	Phone systems - 7841 (Classrooms), 8841/8851 (Offices), 8865 (Video enabled for use with iPhone door entry systems and ADA solutions)
▪ Cisco	4500X Network Switches
▪ Falcon	Alternate manufacturer of door closers
▪ Honeywell	Thermostats - VP525A & TP970 Thermostat Modernization Kit with Universal Adaptor
▪ Ives	Door hardware, continuous & butt hinges, coordinators, flush bolts, door stops and holders, kick plates, mop plates, push/pul plates, latch protectors, door silencers
▪ Milestone	XProtect Pro CCTV systems
▪ National Guard Products	Door thresholds, door smoke seal, weatherstrip, door sweeps, astragals, mullion seals, drip guards
▪ Norton	Door closers
▪ Rauland	Clock, Bell, Speaker Systems - Telecenter TCU
▪ Schlage	Door hardware, key system & cylindrical locks
▪ Simplex (JCI)	Fire Alarm Systems, 4100ES
▪ Sloan	Flush Valves, Royal Flushometer
▪ SofTILE	Soft surface pad surfacing

**4.2** A request for a substitution shall be submitted as follows:

**4.2.1** For any request for a substitution prior to bidding, Contractor shall notify the District in writing of such request at least ten (10) days prior to bid opening as indicated in the Instructions to Bidders.

**4.2.2** Requests for Substitutions after award of the Contract shall be submitted within thirty-five (35) days of the date of the Notice of Award.

**4.3** With every request for a substitution, Contractor shall provide data substantiating a request for substitution of “an equal” item, including but not limited to the following:

**4.3.1** All variations of the proposed substitute from the material specified including, but not limited to, principles of operation, materials, or construction finish, thickness or gauge of materials, dimensions, weight, and tolerances;

**4.3.2** Available maintenance, repair or replacement services;

**4.3.3** Increases or decreases in operating, maintenance, repair, replacement, and spare parts costs;

**4.3.4** Whether or not acceptance of the substitute will require other changes in the Work (or in work performed by the District or others under Contract with the District); and

**4.3.5** The time impact on any part of the Work resulting directly or indirectly from acceptance of the proposed substitute.

**4.4** No substitutions shall be made until approved, in writing, by the District. The burden of proof as to equality of any material, process, or article shall rest with Contractor. The Contractor warrants that if substitutes are approved:

**4.4.1** The proposed substitute is equal or superior in all respects to that specified, and that such proposed substitute is suitable and fit for the intended purpose and will perform adequately the function and achieve the results called for by the general design and the Contract Documents;

**4.4.2** The Contractor provides the same warranties and guarantees for the substitute that would be provided for that specified;

**4.4.3** The Contractor shall be fully responsible for the installation of the substitute and any changes in the Work required, either directly or indirectly, because of the acceptance of such substitute, with no increase in Contract Price or Contract Time. Incidental changes or extra component parts required to accommodate the substitute will be made by the Contractor without a change in the Contract Price or Contract Time;

4.4.4 The Contractor shall be responsible for any re-design costs occasioned by District's acceptance and/or approval of any substitute; and

4.4.5 The Contractor shall, in the event that a substitute is less costly than that specified, credit the District with one hundred percent (100%) of the net difference between the substitute and the originally specified material. In this event, the Contractor agrees to execute a deductive Change Order to reflect that credit.

4.5 In the event Contractor furnishes a material, process, or article more expensive than that specified, the difference in the cost of that material, process, or article so furnished shall be borne by Contractor.

4.6 In no event shall the District be liable for any increase in Contract Price or Contract Time due to any claimed delay in the evaluation of any proposed substitute or in the acceptance or rejection of any proposed substitute.

4.7 Contractor shall be responsible for any costs the District incurs for professional services, DSA fees, or delay to the Project Schedule, if applicable, while DSA reviews changes for the convenience of Contractor and/or to accommodate Contractor's means and methods. District may deduct those costs from any amounts owing to the Contractor for the review of the request for substitution, even if the request for substitution is not approved. District, at its sole discretion, shall deduct from the payments due to and/or invoice Contractor for all the professional services and/or DSA fees or delay to the Project Schedule, if applicable, while DSA reviews changes for the convenience of Contractor and/or to accommodate Contractor's means and methods arising herein.

## 5. Weather Days

Time extensions for weather shall be awarded pursuant to the provisions in the other Contract Documents, including but not limited to Articles 4 and 8 in the General Conditions.

Contractor shall specifically include in its schedule and schedule updates (see Section 3.9.1 of the General Conditions) at least the following number of calendar days of weather delay to the critical path (if no number is inserted for a particular month, it shall be assumed to be "0"):

- January = \_\_\_\_\_
- February = \_\_\_\_\_
- March = \_\_\_\_\_
- April = \_\_\_\_\_
- May = \_\_\_\_\_
- June = \_\_\_\_\_
- July = \_\_\_\_\_
- August = \_\_\_\_\_
- September = \_\_\_\_\_
- October = \_\_\_\_\_
- November = \_\_\_\_\_
- December = \_\_\_\_\_

**6. Owner-Controlled or Wrap-Up Insurance Program**

Contractor and all Subcontractors under the Contractor shall participate in and comply with the owner-controlled or wrap-up insurance program (“OCIP”). In addition, Contractor shall procure and maintain, at its own expense, until completion and final acceptance of the Work at least the following insurance from insurance companies with an A.M. Best rating of no less than \_\_\_\_\_, except for those coverages provided by the OCIP as described in the OCIP Manual:

<del>{Commercial General Liability}</del>	Personal Injury Liability, Broad Form Property Damage including completed operations, and Explosion, Collapse and Underground Hazards	<del>{E.G. \$2,000,000}</del>
<del>{Automobile Liability—Any Auto}</del>	Bodily Injury and Property Damage	<del>{E.G. \$4,000,000}</del>
<del>{Workers Compensation}</del>		Statutory limits pursuant to State law
<del>{Employers<sup>2</sup> Liability}</del>		<del>{E.G. \$2,000,000}</del>

**7. Insurance Policy Limits**

Insurance shall be provided as outlined in the Agreement and General Conditions.

**8. Permits, Certificates, Licenses, Fees, Approvals**

**8.1** Payment for Permits, Certificates, Licenses, Fees, and Approvals. As required in the General Conditions, the Contractor shall secure and pay for all permits, licenses, approvals, and certificates necessary for the prosecution of the Work with the exception of the following:

**8.1.1** \_\_\_\_\_

With respect to the above-listed items, Contractor shall be responsible for securing such items; however, District will be responsible for payment of these charges or fees. Contractor shall notify the District of the amount due with respect to such items and to whom the amount is payable. Contractor shall provide the District with an invoice and receipt with respect to such charges or fees.

**8.2** General Permit For Storm Water Discharges Associated With Construction and Land Disturbance Activities

**8.2.1** Contractor acknowledges that all California school districts are obligated to develop and implement the following requirements for the discharge of storm water to surface waters from its construction and land disturbance activities (storm water requirements), without limitation:

**8.2.1.1** Municipal Separate Storm Sewer System (MS4) is a system of conveyances used to collect and/or convey storm water, including, without limitation, catch basins, curbs, gutters, ditches, man-made channels, and storm drains.

**8.2.1.2** Storm Water Pollution Prevention Plan (“SWPPP”) contains specific best management practices (“BMPs”) and establishes numeric effluent limitations at:

**8.2.1.2.1** Sites where the District engages in maintenance (e.g. fueling, cleaning, repairing) for transportation activities.

**8.2.1.2.2** Construction sites where:

**8.2.1.2.2.1** One (1) or more acres of soil will be disturbed, or

**8.2.1.2.2.2** The project is part of a larger common plan of development that disturbs more than one (1) acre of soil.

**8.2.2** Contractor shall comply with any District storm water requirements that are approved by the District and applicable to the Project, at no additional cost to the District.

**8.2.3** At no additional cost to the District, Contractor shall provide a Qualified Storm Water Practitioner who shall be onsite and implement and monitor any and all SWPPP requirements applicable to the Project, including but not limited to:

**8.2.3.1** At least forty eight (48) hours prior to a forecasted rain event, implementing the Rain Event Action Plan (REAP) for any rain event requiring implementation of the REAP, including any erosion and sediment control measures needed to protect all exposed portions of the site; and

**8.2.3.2** Monitoring any Numeric Action Levels (NALs), if applicable.

## **9. Project Labor Agreement/Payroll Records**

The District has entered into a Project Labor Agreement (“PLA”), which covers this Project. Accordingly, the following provision is added as Section 26.4.6:

**9.1** As Contractor and its subcontractors have agreed to be bound by the terms of the PLA entered into by the District [on or about / dated ] \_\_\_\_\_, Contractor and its subcontractors may be excused from uploading CPRs electronically using DIR’s eCPR System by uploading the CPRs by electronic XML file or entering each record manually using the DIR’s iform (or current form) online at <http://www.dir.ca.gov/Public-Works/Certified-Payroll-Reporting.html> , or by using a more current application and



URL. However, within ten (10) days of any request by the District or Labor Commissioner, Contractor and its subcontractors shall provide CPRs showing the name, address, social security number, work classification, straight time, and overtime hours worked each day and week, and the actual per diem wages paid to each journeyman, apprentice, worker, or other employee employed by the Contractor and/or each subcontractor in connection with the Work.

**10. As-Builts and Record Drawings**

**10.1** When called for by Division 1, Contractor shall submit As-Built Drawings pursuant to the Contract Documents consisting of one set of computer-aided design and drafting (“CADD”) files in the following format \_\_\_\_\_, plus one set of As-Built Drawings on vellum or mylar.

**10.2** Contractor shall submit Record Drawings pursuant to the Contract Documents consisting of one set of computer-aided design and drafting (“CADD”) files in the following format \_\_\_\_\_, plus one set of Record Drawings on vellum or mylar].

**11. Fingerprinting**

Contractor shall comply with the fingerprinting requirements as outlined in the Fingerprinting Notice and Acknowledgement Form submitted with Contractor’s bid. See the Instructions to Bidders. Contractor shall not permit any employee to have any contact with District pupils until such time as Contractor has verified in writing to the governing board of the District, that such employee has not been convicted of a violent or serious felony, as defined in Education Code section 45122.1. Contractor shall fully complete and perform all tasks required pursuant to the Fingerprinting Notice and Acknowledgement Form.

**12. Disabled Veteran Business Enterprises**

Contractor shall comply with DVBE requirements when submitting its bid. See the Instructions to Bidders.

**13. [Not Used]**

**14. [Not Used]**

**15. Federal Funds**

As this Project is funded in whole or in part by federal funds, Contractor and all Subcontractors are subject to civil or criminal prosecution for any violation of the federal False Claims Act set forth under section 1001 of title 18 and section 231 of title 31 of the United States Code.

Therefore, the following provisions are added as Section 13.14 of the General Conditions:

## FEDERAL LABOR, WAGE & HOUR, APPRENTICE, AND RELATED PROVISIONS

### **15.1 Minimum Wages**

The Davis-Bacon Act and 29 CFR parts 1 through 7 shall apply if the Project is financed in whole or in part from Federal funds or in accordance with guarantees of a Federal agency or financed from funds obtained by pledge of any contract of a Federal agency to make a loan, grant or annual contribution.

**15.1.1** All laborers and mechanics employed or working upon the Site of the Work (or under the United States Housing Act of 1937 or under the Housing Act of 1949 in the construction or development of the Project), will be paid unconditionally and not less often than once a week, and without subsequent deduction or rebate on any account, except such payroll deductions as are permitted by regulations issued by the Secretary of Labor under the Copeland Act (29 CFR part 3) , the full amount of wages and bona fide fringe benefits, or cash equivalents thereof, due at time of payment computed at rates not less than those contained in the applicable wage determination of the Secretary of Labor regardless of any contractual relationship which may be alleged to exist between the Contractor and such laborers and mechanics.

Contributions made or costs reasonably anticipated for bona fide fringe benefits under section 1(b)(2) of the Davis-Bacon Act on behalf of laborers or mechanics are considered wages paid to such laborers or mechanics, subject to the provisions of this section, including but not limited to paragraph 27.1.7; also, regular contributions made or costs incurred for more than a weekly period, but not less often than quarterly, under plans, funds, or programs which cover the particular weekly period, are deemed to be constructively made or incurred during such weekly period. Such laborers and mechanics shall be paid the appropriate wage rate and fringe benefits on the wage determination for the classification of Work actually performed, without regard to skill, except as provided in 29 CFR 5.5(a)(4). Laborers or mechanics performing Work in more than one classification may be compensated at the rate specified for each classification for the time actually worked therein: Provided, that the employer's payroll records accurately set forth the time spent in each classification in which Work is performed. The wage determination including any additional classification and wage rates conformed under this section, including but not limited to paragraph 27.1.6 and the Davis-Bacon poster (WH-1321) shall be posted at all times by the Contractor and its Subcontractors at the Site of the Work in a prominent and accessible place where it can be easily seen by the workers.

**15.1.2** Any class of laborers and mechanics, including helpers, and which is to employed under the Contract which is not listed in the wage determination shall be classified in conformance with the wage determination. An additional classification and wage rate and fringe benefits will not be approved unless when the following criteria have been met:

**15.1.2.1** The Work to be performed by the classification requested is not performed by a classification in the wage determination; and

**15.1.2.2** The classification is utilized in the area by the construction industry; and

**15.1.2.3** The proposed wage rate, including any bona fide fringe benefits, bears a reasonable relationship to the wage rates contained in the wage determination.

**15.1.3** If the Contractor and the laborers and mechanics to be employed in the classification (if known), or their representatives, and the District agree on the classification and wage rate (including the amount designated for fringe benefits where appropriate), a report of the action taken shall be sent by the Contractor to the Administrator of the Wage and Hour Division, Employment Standards Administration, U.S. Department of Labor, Washington, DC 20210.

**15.1.4** In the event the Contractor, the laborers or mechanics to be employed in the classification or their representatives, and the District do not agree on the proposed classification and wage rate (including the amount designated for fringe benefits, where appropriate), the Contractor shall provide the questions, including the views of all interested parties and the recommendation of the District, to the District for the District's review and referral to the Administrator for determination.

**15.1.5** The wage rate (including fringe benefits where appropriate) determined pursuant to this section, shall be paid to all workers performing Work in the classification under this Contract from the first day on which Work is performed in the classification.

**15.1.6** Whenever the minimum wage rate prescribed in any applicable wage determination for a class of laborers or mechanics includes a fringe benefit which is not expressed as an hourly rate, Contractor shall either pay the benefit as stated in the wage determination or shall pay another bona fide fringe benefit or an hourly cash equivalent thereof.

**15.1.7** If the Contractor does not make payments to a trustee or other third person, the Contractor may consider, as part of the wages of any laborer or mechanic, the amount of any costs reasonably anticipated in providing bona fide fringe benefits under a plan or program, provided that the Secretary of Labor has found, upon the written request of the Contractor, that the applicable standards of the Davis-Bacon Act have been met. If the Secretary of Labor so requires, the Contractor shall set aside in a separate account sufficient assets to meet obligations under the plan or program.

**15.2 Withholding.** District may, upon its own action or upon written request of an authorized representative of the Department of Labor, withhold or cause to be withheld from the Contractor under this Contract or any other Federal contract with the same Contractor, or any other federally-assisted contract subject to Davis-Bacon prevailing wage requirements, which is held by the same Contractor, so much of the accrued payments or advances as may be considered necessary to pay laborers and mechanics, including apprentices, trainees, and helpers, employed by the Contractor or any Subcontractor the full amount of wages required by the Contract. In the event of Contractor's or any Subcontractors' failure to pay any laborer or mechanic, including any apprentice, trainee, or helper, employed or working on the Site of the Work (or under the

United States Housing Act of 1937 or under the Housing Act of 1949 in the construction or development of the project), all or part of the wages required by the Contract, the District may, after written notice to the Contractor, sponsor, applicant, or owner, take such action as it deems necessary to cause the suspension of any further payment, advance, or guarantee of funds until such violations have ceased.

### **15.3 Payrolls and basic records.**

**15.3.1** Payrolls and basic records relating thereto shall be maintained by the Contractor during the course of the Work and preserved for a period of three years thereafter for all laborers and mechanics working at the Site of the Work (or under the United States Housing Act of 1937, or under the Housing Act of 1949, in the construction or development of the project). Such records shall contain the name, address, and social security number of each worker, his or her correct classification, hourly rates of wages paid (including rates of contributions or costs anticipated for bona fide fringe benefits or cash equivalents thereof of the types described in section 1(b)(2)(B) of the Davis-Bacon Act), daily and weekly number of hours worked, deductions made and actual wages paid. Whenever the Secretary of Labor has found under 29 CFR 5.5(a)(1)(iv) that the wages of any laborer or mechanic include the amount of any costs reasonably anticipated in providing benefits under a plan or program described in section 1(b)(2)(B) of the Davis-Bacon Act, the Contractor shall maintain records that show that the commitment to provide such benefits is enforceable, that the plan or program is financially responsible, and that the plan or program has been communicated in writing to the laborers or mechanics affected, and records which show the costs anticipated or the actual cost incurred in providing such benefits. Contractors employing apprentices or trainees under approved programs shall maintain written evidence of the registration of apprenticeship programs and certification of trainee programs, the registration of the apprentices and trainees, and the ratios and wage rates prescribed in the applicable programs.

**15.3.2** The Contractor shall submit weekly for each week in which any Contract Work is performed a copy of all payrolls to the District. The payrolls submitted shall set out accurately and completely all of the information required to be maintained under 29 CFR 5.5(a)(3)(i), except that full social security numbers and home addresses shall not be included on weekly transmittals. Instead the payrolls shall only need to include an individually identifying number for each employee (e.g., the last four digits of the employee's social security number). The required weekly payroll information shall be submitted on a form acceptable to the District. Optional Form WH-347 is available for this purpose from the Wage and Hour Division Web site at <https://www.dol.gov/whd/programs/dbra/wh347.htm> or its successor site. Contractor is responsible for the submission of copies of payrolls by all Subcontractors. Contractor and Subcontractors shall maintain the full social security number and current address of each covered worker, and shall provide them upon request to the District, the Contractor, or the Wage and Hour Division of the Department of Labor for purposes of an investigation or audit of compliance with prevailing wage requirements. Contractor may require a Subcontractor to provide addresses and social security numbers to the Contractor for its own records, without weekly submission to the District or other government agency

**15.3.3** Each payroll submitted shall be accompanied by a “Statement of Compliance,” signed by the Contractor or Subcontractor or his or her agent who pays or supervises the payment of the persons employed under the Contract and shall certify the following:

**15.3.3.1** That the payroll for the payroll period contains the information required to be provided under 29 CFR 5.5 (a)(3)(ii) of Regulations, 29 CFR part 5,

**15.3.3.2** That the appropriate information is being maintained under 29 CFR 5.5 (a)(3)(i) of Regulations, 29 CFR part 5, and

**15.3.3.3** That such information is correct and complete;

**15.3.3.4** That each laborer or mechanic (including each helper, apprentice, and trainee) employed on the Contract during the payroll period has been paid the full weekly wages earned, without rebate, either directly or indirectly, and

**15.3.3.5** That no deductions have been made either directly or indirectly from the full wages earned, other than permissible deductions as set forth in Regulations, 29 CFR part 3;

**15.3.3.6** That each laborer or mechanic has been paid not less than the applicable wage rates and fringe benefits or cash equivalents for the classification of Work performed, as specified in the applicable wage determination incorporated into or applicable to the Contract.

**15.3.3.7** The weekly submission of a properly executed certification in the form set forth on the reverse side of Optional Form WH-347 shall satisfy the requirement for submission of the “Statement of Compliance” required by paragraph 27.3.3 of this section.

**15.3.3.8** The falsification of any of the above certifications may subject the Contractor or one or more Subcontractors to civil or criminal prosecution under section 1001 of title 18 and section 231 of title 31 of the United States Code.

**15.3.3.9** The Contractor or Subcontractor shall make the records required under this section available for inspection, copying, or transcription by authorized representatives of the District or the federal Department of Labor, and shall permit representatives to interview employees during working hours on the job. If the Contractor or Subcontractor fails to submit the required records or to make them available, the Federal agency may, after written notice to the Contractor, sponsor, applicant, or owner, take such action as may be necessary to cause the suspension of any further payment, advance, or guarantee of funds. Furthermore, failure to submit the required records upon request or to make such records available may be grounds for debarment action pursuant to 29 CFR 5.12.

## **15.4 Apprentices and trainees**

**15.4.1 Apprentices.** Apprentices will be permitted to work at less than the predetermined rate for the Work they performed when they are employed pursuant to and

individually registered in a bona fide apprenticeship program registered with the U.S. Department of Labor, Employment and Training Administration, Office of Apprenticeship Training, Employer and Labor Services, or with a State Apprenticeship Agency recognized by the Office, or if a person is employed in his or her first ninety (90) days of probationary employment as an apprentice in an eligible apprenticeship program, who is not individually registered in the program, but who has been certified by the Office of Apprenticeship Training, Employer and Labor Services or a State Apprenticeship Agency (where appropriate) to be eligible for probationary employment as an apprentice. The allowable ratio of apprentices to journeymen on the job Site in any craft classification shall not be greater than the ratio permitted to the Contractor as to the entire work force under the registered program. Any worker listed on a payroll at an apprentice wage rate, who is not registered or otherwise employed as stated above, shall be paid not less than the applicable wage rate on the wage determination for the classification of Work actually performed. In addition, any apprentice performing Work on the job Site in excess of the ratio permitted under the registered program shall be paid not less than the applicable wage rate on the wage determination for the Work actually performed. Where a Contractor is performing construction on a project in a locality other than that in which its program is registered, the ratios and wage rates (expressed in percentages of the journeyman's hourly rate) specified in the Contractor's or Subcontractor's registered program shall be observed. Every apprentice must be paid at not less than the rate specified in the registered program for the apprentice's level of progress, expressed as a percentage of the journeyman hourly rate specified in the applicable wage determination. Apprentices shall be paid fringe benefits in accordance with the provisions of the apprenticeship program. If the apprenticeship program does not specify fringe benefits, apprentices must be paid the full amount of fringe benefits listed on the wage determination for the applicable classification. If the Administrator determines that a different practice prevails for the applicable apprentice classification, fringes shall be paid in accordance with that determination. In the event the Office of Apprenticeship Training, Employer and Labor Services, or a State Apprenticeship Agency recognized by the Office, withdraws approval of an apprenticeship program, the Contractor will no longer be permitted to utilize apprentices at less than the applicable predetermined rate for the Work performed until an acceptable program is approved.

**15.4.2 Trainees.** Except as provided in 29 CFR 5.16, trainees will not be permitted to Work at less than the predetermined rate for the Work performed unless they are employed pursuant to and individually registered in a program which has received prior approval, evidenced by formal certification by the U.S. Department of Labor, Employment and Training Administration. The ratio of trainees to journeymen on the job Site shall not be greater than permitted under the plan approved by the Employment and Training Administration. Every trainee must be paid at not less than the rate specified in the approved program for the trainee's level of progress, expressed as a percentage of the journeyman hourly rate specified in the applicable wage determination. Trainees shall be paid fringe benefits in accordance with the provisions of the trainee program. If the trainee program does not mention fringe benefits, trainees shall be paid the full amount of fringe benefits listed on the wage determination unless the Administrator of the Wage and Hour Division determines that there is an apprenticeship program associated with the corresponding journeyman wage rate on the wage determination which provides for less

than full fringe benefits for apprentices. Any employee listed on the payroll at a trainee rate who is not registered and participating in a training plan approved by the Employment and Training Administration shall be paid not less than the applicable wage rate on the wage determination for the classification of Work actually performed. In addition, any trainee performing Work on the job Site in excess of the ratio permitted under the registered program shall be paid not less than the applicable wage rate on the wage determination for the Work actually performed. In the event the Employment and Training Administration withdraws approval of a training program, the Contractor will no longer be permitted to utilize trainees at less than the applicable predetermined rate for the Work performed until an acceptable program is approved.

**15.6 Equal employment opportunity.** The utilization of apprentices, trainees and journeymen under this part shall be in conformity with the equal employment opportunity requirements of Executive Order 11246, as amended, and 29 CFR part 30.

**15.7 Compliance with Copeland Act requirements.** Contractor shall comply with the requirements of 29 CFR part 3, which are incorporated by reference in this Contract.

**15.8 Subcontracts.** The Contractor or Subcontractor shall insert in any subcontracts the clauses contained in 29 CFR 5.5(a)(1) through (10) and such other clauses as the Federal agency may by appropriate instructions require, and also a clause requiring the Subcontractors to include these clauses in any lower tier subcontracts. The Contractor shall be responsible for the compliance by any Subcontractor or lower tier Subcontractor with all the Contract clauses in 29 CFR 5.5.

**15.9 Contract termination: debarment.** A breach of the Contract clauses in 29 CFR 5.5 may be grounds for termination of the Contract, and for debarment as a Contractor and a Subcontractor as provided in 29 CFR 5.12.

**15.10 Compliance with Davis-Bacon and Related Act requirements.** All rulings and interpretations of the Davis-Bacon and Related Acts contained in 29 CFR parts 1, 3, and 5 are herein incorporated by reference in this Contract.

**15.11 Disputes concerning labor standards.** Disputes arising out of the labor standards provisions of this Contract shall not be subject to the general disputes clause of this Contract. Such disputes shall be resolved in accordance with the procedures of the Department of Labor set forth in 29 CFR parts 5, 6, and 7. Disputes within the meaning of this clause include disputes between the Contractor (or any of its Subcontractors) and the contracting agency, the U.S. Department of Labor, or the employees or their representatives.

**15.12 Certification of eligibility.**

**15.12.1** By entering into this Contract, the Contractor certifies that neither it (nor he or she) nor any person or firm who has an interest in the Contractor's firm is a person or firm ineligible to be awarded Government contracts by virtue of section 3(a) of the Davis-Bacon Act or 29 CFR 5.12(a)(1).

**15.12.2** No part of this Contract shall be subcontracted to any person or firm ineligible for award of a Government contract by virtue of section 3(a) of the Davis-Bacon Act or 29 CFR 5.12(a)(1).

**15.12.3** Contractor shall be subject to the penalty for making false statements prescribed in the U.S. Criminal Code, 18 U.S.C. 1001.

**16. Clauses Mandated by Contract Work Hours and Safety Standards Act.**

As used in the following paragraphs, the terms laborers and mechanics include watchmen and guards.

**16.1 Overtime requirements.** No Contractor or Subcontractor contracting for any part of the Contract Work which may require or involve the employment of laborers or mechanics shall require or permit any such laborer or mechanic in any workweek in which he or she is employed on such Work to work in excess of forty hours in such workweek unless such laborer or mechanic receives compensation at a rate not less than one and one-half times the basic rate of pay for all hours worked in excess of forty hours in such workweek.

**16.2 Violation; liability for unpaid wages; liquidated damages.** In the event of any violation of the clause set forth in the foregoing paragraph the Contractor and any Subcontractor responsible therefor shall be liable for the unpaid wages. In addition, such Contractor and Subcontractor shall be liable to the United States for liquidated damages. Such liquidated damages shall be computed with respect to each individual laborer or mechanic, including watchmen and guards, employed in violation of the foregoing paragraph, in the sum of \$10 for each calendar day on which such individual was required or permitted to Work in excess of the standard workweek of forty hours without payment of the overtime wages required by the foregoing paragraph.

**16.3 Withholding for unpaid wages and liquidated damages.** The District may upon its own action or upon written request of an authorized representative of the Department of Labor withhold or cause to be withheld, from any moneys payable on account of Work performed by the Contractor or Subcontractor under the Contract or any other Federal contract with the same Contractor, or any other federally-assisted contract subject to the Contract Work Hours and Safety Standards Act, which is held by the same Contractor, such sums as may be determined to be necessary to satisfy any liabilities of such Contractor or Subcontractor for unpaid wages and liquidated damages as provided in the foregoing paragraph.

**16.3.1 Subcontracts.** The Contractor or Subcontractor shall insert in any subcontracts the foregoing paragraphs concerning "Overtime requirements" and "Violation; liability for unpaid wages; liquidated damages" and also a clause requiring each Subcontractor to include these clauses in any lower tier subcontracts. Contractor shall be responsible for compliance by any Subcontractor or lower tier Subcontractor with the clauses set forth in paragraphs 27.11.1 through 27.11.4 of this section.



**17. Preliminary Schedule of Values**

The schedule of values shall be submitted as required by the Notice to Proceed and General Conditions section 9.2.1.A. In addition, a preliminary schedule of values shall be submitted within five (5) days of the Notice to Proceed, which must include, at a minimum, the following information and the following structure:

**17.1** The preliminary schedule of values shall not provide for values any greater than the following percentages of the Contract value:

**17.1.1** Mobilization and layout combined to equal not more than one percent (1%);

**17.1.2** Submittals, samples and shop drawings combined to equal not more than three percent (3%); and

**17.1.3** Bonds and insurance combined to equal not more than two percent (2%).

END OF DOCUMENT

**HAZARDOUS MATERIALS**  
**PROCEDURES & REQUIREMENTS**

**1. Summary**

This document includes information applicable to hazardous materials and hazardous waste abatement.

**2. Notice of Hazardous Waste or Materials**

- a. Contractor shall give notice in writing to the District, the Construction Manager, and the Architect promptly, before any of the following materials are disturbed, and in no event later than twenty-four (24) hours after first observance, of any:
  - 1) Material that Contractor believes may be a material that is hazardous waste or hazardous material, as defined in section 25117 of the Health and Safety Code, that is required to be removed to a Class I, Class II, or Class III disposal site in accordance with provisions of existing law;
  - 2) Other material that may present a substantial danger to persons or property exposed thereto in connection with Work at the site.
- b. Contractor's written notice shall indicate whether the hazardous waste or material was shown or indicated in the Contract Documents to be within the scope of Work, and whether the materials were brought to the site by Contractor, its Subcontractors, suppliers, or anyone else for whom Contractor is responsible. As used in this section the term "hazardous materials" shall include, without limitation, asbestos, lead, Polychlorinated biphenyl (PCB), petroleum and related hydrocarbons, and radioactive material.
- c. In response to Contractor's written notice, the District shall investigate the identified conditions.
- d. If the District determines that conditions do not involve hazardous materials or that no change in terms of Contract is justified, the District shall so notify Contractor in writing, stating reasons. If the District and Contractor cannot agree on whether conditions justify an adjustment in Contract Price or Contract Time, or on the extent of any adjustment, Contractor shall proceed with the Work as directed by the District.
- e. If after receipt of notice from the District, Contractor does not agree to resume Work based on a reasonable belief it is unsafe, or does not agree to resume Work under special conditions, then District may order such portion of Work that is in connection with such hazardous condition or such affected area to be deleted from the Work, or performed by others, or District may invoke its rights to terminate the Contract in whole or in part. District will determine entitlement to or the amount or extent of an adjustment, if any, in Contract Price or Contract Time as a result of deleting such portion of Work, or performing the Work by others.

- f. If Contractor stops Work in connection with any hazardous condition and in any area affected thereby, Contractor shall immediately redeploy its workers, equipment, and materials, as necessary, to other portions of the Work to minimize delay and disruption.

### **3. Additional Warranties and Representations**

- a. Contractor represents and warrants that it, its employees, and its subcontractors and their employees, shall at all times have the required levels of familiarity with the Site and the Work, training, and ability to comply fully with all applicable laws and contractual requirements for safe and expeditious performance of the Work, including whatever training is or may be required regarding the activities to be performed (including, but not limited to, all training required to address adequately the actual or potential dangers of Contract performance).
- b. Contractor represents and warrants that it, its employees, and its subcontractors and their employees, shall at all times have and maintain in good standing any and all certifications and licenses required by applicable federal, state, and other governmental and quasi-governmental requirements applicable to the Work.
- c. Contractor represents and warrants that it has studied carefully all requirements of the Specifications regarding procedures for demolition, hazardous waste abatement, or safety practices, specified in the Contract, and prior to submitting its bid, has either (a) verified to its satisfaction that the specified procedures are adequate and sufficient to achieve the results intended by the Contract Documents, or (b) by way of approved "or equal" request or request for clarification and written Addenda, secured changes to the specified procedures sufficient to achieve the results intended by the Contract Documents. Contractor accepts the risk that any specified procedure will result in a completed Project in full compliance with the Contract Documents.

### **4. Monitoring and Testing**

- a. District reserves the right, in its sole discretion, to conduct air monitoring, earth monitoring, Work monitoring, and any other tests (in addition to testing required under the agreement or applicable law), to monitor Contract requirements of safe and statutorily compliant work methods and (where applicable) safe re-entry level air standards under state and federal law upon completion of the job, and compliance of the work with periodic and final inspection by public and quasi-public entities having jurisdiction.
- b. Contractor acknowledges that District has the right to perform, or cause to be performed, various activities and tests including, but not limited to, pre-abatement, during abatement, and post-abatement air monitoring, that District shall have no obligation to perform said activities and tests, and that a portion of said activities and tests may take place prior to the completion of the Work by Contractor. In the event District elects to perform these activities and tests, Contractor shall afford District ample access to the Site and all areas of the Work as may be necessary for the performance of these activities and tests. Contractor will include the potential impact of these activities or tests by District in the Contract Price and the Scheduled Completion Date.

- c. Notwithstanding District's rights granted by this paragraph, Contractor may retain its own industrial hygiene consultant at Contractor's own expense and may collect samples and may perform tests including, but not limited to, pre-abatement, during abatement, and post-abatement personal air monitoring, and District reserves the right to request documentation of all such activities and tests performed by Contractor relating to the Work and Contractor shall immediately provide that documentation upon request.

**5. Compliance with Laws**

- a. Contractor shall perform safe, expeditious, and orderly work in accordance with the best practices and the highest standards in the hazardous waste abatement, removal, and disposal industry, the applicable law, and the Contract Documents, including, but not limited to, all responsibilities relating to the preparation and return of waste shipment records, all requirements of the law, delivering of all requisite notices, and obtaining all necessary governmental and quasi-governmental approvals.
- b. Contractor represents that it is familiar with and shall comply with all laws applicable to the Work or completed Work including, but not limited to, all federal, state, and local laws, statutes, standards, rules, regulations, and ordinances applicable to the Work relating to:
  - (1) The protection of the public health, welfare and environment;
  - (2) Storage, handling, or use of asbestos, PCB, lead, petroleum based products, radioactive material, or other hazardous materials;
  - (3) The generation, processing, treatment, storage, transport, disposal, destruction, or other management of asbestos, PCB, lead, petroleum, radioactive material, or hazardous waste materials or other waste materials of any kind; and
  - (4) The protection of environmentally sensitive areas such as wetlands and coastal areas.

**6. Disposal**

- a. Contractor has the sole responsibility for determining current waste storage, handling, transportation, and disposal regulations for the job Site and for each waste disposal facility. Contractor must comply fully at its sole cost and expense with these regulations and any applicable law. District may, but is not obligated to, require submittals with this information for it to review consistent with the Contract Documents.
- b. Contractor shall develop and implement a system acceptable to District to track hazardous waste from the Site to disposal, including appropriate "Hazardous Waste Manifests" on the EPA form, so that District may track the volume of waste it put in each landfill and receive from each landfill a certificate of receipt.
- c. Contractor shall provide District with the name and address of each waste disposal facility prior to any disposal, and District shall have the express right to

reject any proposed disposal facility. Contractor shall not use any disposal facility to which District has objected. Contractor shall document actual disposal or destruction of waste at a designated facility by completing a disposal certificate or certificate of destruction forwarding the original to the District.

## **7. Permits**

- a. Before performing any of the Work, and at such other times as may be required by applicable law, Contractor shall deliver all requisite notices and obtain the approval of all governmental and quasi-governmental authorities having jurisdiction over the Work. Contractor shall submit evidence satisfactory to District that it and any disposal facility:
  - 1) have obtained all required permits, approvals, and the like in a timely manner both prior to commencement of the Work and thereafter as and when required by applicable law; and
  - 2) are in compliance with all such permits, approvals and the regulations.

For example, before commencing any work in connection with the Work involving asbestos-containing materials, or PCBs, or other hazardous materials subject to regulation, Contractor agrees to provide the required notice of intent to renovate or demolish to the appropriate state or federal agency having jurisdiction, by certified mail, return receipt requested, or by some other method of transmittal for which a return receipt is obtained, and to send a copy of that notice to District. Contractor shall not conduct any Work involving asbestos-containing materials or PCBs unless Contractor has first confirmed that the appropriate agency having jurisdiction is in receipt of the required notification. All permits, licenses, and bonds that are required by governmental or quasi-governmental authorities, and all fees, deposits, tap fees, offsite easements, and asbestos and PCB disposal facilities expenses necessary for the prosecution of the Work, shall be procured and paid for by Contractor. Contractor shall give all notices and comply with the all applicable laws bearing on the conduct of the Work as drawn and specified. If Contractor observes or reasonably should have observed that Plans and Specifications and other Contract Documents are at variance therewith, it shall be responsible for promptly notifying District in writing of such fact. If Contractor performs any Work contrary to applicable laws, it shall bear all costs arising therefrom.

- b. In the case of any permits or notices held in District's name or of necessity to be made in District's name, District shall cooperate with Contractor in securing the permit or giving the notice, but the Contractor shall prepare for District review and execution upon approval, all necessary applications, notices, and other materials.

## **8. Indemnification**

To the fullest extent permitted by law, the indemnities and limitations of liability expressed throughout the Contract Documents apply with equal force and effect to any claims or liabilities imposed or existing by virtue of the removal, abatement, and disposal of hazardous waste. This includes, but is not limited to, liabilities connected

to the selection and use of a waste disposal facility, a waste transporter, personal injury, property damage, loss of use of property, damage to the environment or natural resources, or "disposal" and "release" of materials associated with the Work (as defined in 42 U.S.C. § 9601 *et seq.*).

**9. Termination**

District shall have an absolute right to terminate for default immediately without notice and without an opportunity to cure should Contractor knowingly or recklessly commit a material breach of the terms of the Contract Documents, or any applicable law, on any matter involving the exposure of persons or property to hazardous waste. However, if the breach of contract exposing persons or property to hazardous waste is due solely to an ordinary, unintentional, and non-reckless failure to exercise reasonable care, then the procedures for termination for cause shall apply without modification.

END OF DOCUMENT

# **DIVISION 01 SPECIFICATIONS**

## **for Design-Bid-Build Contract**

### **For the Various Sites Door Entry Systems Group 1 & 2 Project**

#### **Oakland Unified School District**

If any provision in these Division 01 specifications conflicts with any provision in the other Contract Documents, then the provision in the other Contract Document shall control.

***[NOTE TO OWNER: For each project, fill in the necessary information for that project (as highlighted in yellow) in Sections 01 11 00, 01 21 00, 01 22 00, 01 32 00, 01 32 13, 01 45 00, 01 50 00, and 01 52 13.]***

**01 11 00**

**SUMMARY OF WORK ..... 12**

**PART 1 - GENERAL ..... 12**

1.01 RELATED DOCUMENTS AND PROVISIONS, AND CONFLICTS: ..... 12

1.02 SUMMARY OF WORK COVERED BY CONTRACT DOCUMENTS ..... 12

1.03 CONTRACTS ..... 12

1.04 WORK BY OTHERS ..... 12

1.05 CODES, REGULATIONS, AND STANDARDS ..... 13

1.06 PROJECT RECORD DOCUMENTS: ..... 13

1.07 EXAMINATION OF EXISTING CONDITIONS ..... 14

1.08 CONTRACTOR'S USE OF PREMISES ..... 14

1.09 PROTECTION OF EXISTING STRUCTURES AND UTILITIES ..... 15

1.10 UTILITY SHUTDOWNS AND INTERRUPTIONS ..... 15

1.11 STRUCTURAL INTEGRITY ..... 15

**PART 2 – PRODUCTS (NOT USED) ..... 15**

**PART 3 – EXECUTION (NOT USED) ..... 15**

**01 21 00**

**ALLOWANCES ..... 16**

**PART 1 - GENERAL ..... 16**

1.01 RELATED DOCUMENTS AND PROVISIONS: ..... 16

**PART 2 – PRODUCTS (NOT USED) ..... 19**

**PART 3 – EXECUTION ..... 19**

3.01 EXAMINATION: ..... 19

3.02 PREPARATION: ..... 19

3.03 SCHEDULE OF ALLOWANCES IN CONTRACT (DELETE F NOT APPLICABLE)  
19

**01 22 00**

**ALTERNATES AND UNIT PRICING ..... 20**

**PART 1 – ALTERNATES ..... 20**

1.01 RELATED DOCUMENTS AND PROVISIONS: ..... 20

1.02 DESCRIPTION ..... 20

1.03 GENERAL ..... 20

1.04 BASE BID ..... 20

1.05 ALTERNATES ..... 20

**PART 2 - UNIT PRICING ..... 21**

2.01 GENERAL ..... 21

2.02 UNIT PRICES ..... 21



<b>01 25 13</b>	
<b>PRODUCT OPTIONS AND SUBSTITUTIONS.....</b>	<b>22</b>
<b>PART 1 - GENERAL .....</b>	<b>22</b>
1.01    RELATED DOCUMENTS AND PROVISIONS .....	22
1.02    SUBSTITUTIONS OF MATERIALS AND EQUIPMENT (SEE GENERAL CONDITIONS § 3.11):	22
<b>PART 2 – PRODUCTS (NOT USED) .....</b>	<b>23</b>
<b>PART 3 – EXECUTION (NOT USED) .....</b>	<b>23</b>
<b>01 29 00</b>	
<b>1.01.    GENERAL INFORMATION.....</b>	<b>24</b>
<b>1.02.    MAKING PAYMENT .....</b>	<b>24</b>
<b>CONDITIONAL WAIVER AND RELEASE ON PROGRESS PAYMENT (CIVIL CODE SECTION 8132) .....</b>	<b>25</b>
<b>UNCONDITIONAL WAIVER AND RELEASE ON PROGRESS PAYMENT (CIVIL CODE SECTION 8134) .....</b>	<b>27</b>
<b>CONDITIONAL WAIVER AND RELEASE ON FINAL PAYMENT (CIVIL CODE SECTION 8136) .....</b>	<b>29</b>
<b>UNCONDITIONAL WAIVER AND RELEASE ON FINAL PAYMENT (CIVIL CODE SECTION 8138) .....</b>	<b>30</b>
<b>01 30 00</b>	
<b>ADMINISTRATIVE REQUIREMENTS.....</b>	<b>31</b>
<b>PART 1 - GENERAL .....</b>	<b>31</b>
1.01    SUMMARY: .....	31
<b>01 31 00</b>	
<b>PROJECT MANAGEMENT AND COORDINATION .....</b>	<b>38</b>
<b>PART 1 - GENERAL .....</b>	<b>38</b>
1.01    RELATED DOCUMENTS:.....	38
<b>01 31 19</b>	
<b>PROJECT MEETINGS .....</b>	<b>52</b>
<b>PART 1 – GENERAL .....</b>	<b>52</b>
1.01    RELATED DOCUMENTS AND PROVISIONS: .....	52
1.02    PROGRESS MEETINGS: .....	52
1.03    PRE-INSTALLATION/PERFORMANCE MEETING: .....	53
<b>PART 2 - PRODUCTS (NOT USED).....</b>	<b>53</b>

<b>PART 3 - EXECUTION (NOT USED).....</b>	<b>53</b>
<b>01 32 00</b>	
<b>CONSTRUCTION PROGRESS DOCUMENTATION .....</b>	<b>54</b>
<b>PART 1 - GENERAL .....</b>	<b>54</b>
1.01    RELATED DOCUMENTS:.....	54
<b>01 32 13</b>	
<b>SCHEDULING OF WORK .....</b>	<b>66</b>
<b>PART 1 – GENERAL .....</b>	<b>66</b>
1.01    RELATED DOCUMENTS AND PROVISIONS:.....	66
1.02    SECTION INCLUDES: .....	66
1.03    CONSTRUCTION SCHEDULE; HOURS OF WORK:.....	66
1.04    QUALIFICATIONS.....	67
1.05    GENERAL .....	67
1.06    [NOT USED] .....	68
1.07    BASELINE CPM SCHEDULE.....	68
1.08    ADJUSTMENTS TO BASELINE CPM SCHEDULE .....	71
1.09    MONTHLY CPM SCHEDULE UPDATE SUBMITTALS .....	72
1.10    SCHEDULE REVISIONS .....	73
1.11    RECOVERY SCHEDULE.....	74
1.12    TIME IMPACTS EVALUATION (“TIE”) FOR CHANGE ORDERS, AND OTHER DELAYS .....	74
1.13    TIME EXTENSIONS.....	75
1.14    SCHEDULE REPORTS.....	75
1.15    PROJECT STATUS REPORTING.....	76
1.16    WEEKLY SCHEDULE REPORT .....	77
1.17    DAILY CONSTRUCTION REPORTS .....	77
1.18    PERIODIC VERIFIED REPORTS .....	78
<b>PART 2 – PRODUCTS (NOT USED) .....</b>	<b>78</b>
<b>PART 3 - EXECUTION (NOT USED).....</b>	<b>78</b>
<b>01 33 00</b>	
<b>SUBMITTALS .....</b>	<b>79</b>
<b>PART 1 - GENERAL .....</b>	<b>79</b>
1.01    RELATED DOCUMENTS AND PROVISIONS:.....	79
1.02    SECTION INCLUDES: .....	79
1.03    SHOP DRAWINGS: .....	81
1.04    PRODUCT DATA OR NON REPRODUCIBLE SUBMITTALS: .....	83
1.05    SAMPLES:.....	83
1.06    REVIEW AND RESUBMISSION REQUIREMENTS:.....	84

<b>PART 2 – PRODUCTS (NOT USED)</b> .....	<b>85</b>
<b>PART 3 - EXECUTION (NOT USED)</b> .....	<b>85</b>
<b>01 35 13</b>	
<b>SITE STANDARDS</b> .....	<b>86</b>
<b>PART 1 – GENERAL</b> .....	<b>86</b>
1.01    RELATED DOCUMENTS AND PROVISIONS: .....	86
1.02    REQUIREMENTS OF THE OWNER: .....	86
<b>PART 2 - PRODUCTS (NOT USED)</b> .....	<b>87</b>
<b>PART 3 - EXECUTION (NOT USED)</b> .....	<b>87</b>
<b>01 40 00</b>	
<b>QUALITY REQUIREMENTS</b> .....	<b>88</b>
<b>PART 1 - GENERAL</b> .....	<b>88</b>
1.01    RELATED DOCUMENTS:.....	88
<b>01 41 00</b>	
<b>REGULATORY REQUIREMENTS</b> .....	<b>103</b>
<b>PART 1 - GENERAL</b> .....	<b>103</b>
1.01    RELATED DOCUMENTS AND PROVISIONS: .....	103
1.02    DESCRIPTION:.....	103
1.03    REQUIREMENTS OF REGULATORY AGENCIES: .....	103
<b>PART 2 – PRODUCTS (NOT USED)</b> .....	<b>105</b>
<b>PART 3 – EXECUTION (NOT USED)</b> .....	<b>105</b>
<b>01 42 13</b>	
<b>ABBREVIATIONS AND ACRONYMS</b> .....	<b>106</b>
<b>PART 1 – GENERAL</b> .....	<b>106</b>
1.01    RELATED DOCUMENTS AND PROVISIONS: .....	106
1.02    DOCUMENT INCLUDES:.....	106
<b>PART 2 - PRODUCTS (NOT USED)</b> .....	<b>108</b>
<b>PART 3 - EXECUTION (NOT USED)</b> .....	<b>108</b>
<b>01 42 16</b>	
<b>QUALITY ASSURANCE</b> .....	<b>109</b>
<b>PART 1 - GENERAL</b> .....	<b>109</b>
1.01    RELATED DOCUMENTS AND PROVISION .....	109
1.02    QUALITY ASSURANCE: .....	109

**01 42 19**

**REFERENCES ..... 110**

**PART 1 - GENERAL ..... 110**

    1.01 SCHEDULE OF REFERENCES: ..... 110

**PART 2 - PRODUCTS (NOT USED)..... 130**

**PART 3 - EXECUTION (NOT USED)..... 130**

**01 43 00**

**MATERIALS AND EQUIPMENT ..... 131**

**PART 1 - GENERAL ..... 131**

    1.01 RELATED DOCUMENTS AND PROVISIONS ..... 131

    1.02 MATERIAL AND EQUIPMENT ..... 131

    1.03 MATERIAL AND EQUIPMENT COLORS ..... 131

    1.04 DELIVERY, STORAGE, AND HANDLING ..... 131

**PART 2 - PRODUCTS ..... 132**

    2.01 MANUFACTURERS ..... 132

    2.02 FACILITIES AND EQUIPMENT ..... 132

    2.03 MATERIAL REFERENCE STANDARDS..... 132

**PART 3 - EXECUTION ..... 133**

    3.01 WORKMANSHIP ..... 133

    3.02 COORDINATION ..... 133

    3.03 COMPLETENESS ..... 133

    3.04 APPROVED INSTALLER OR APPLICATOR ..... 133

    3.05 MANUFACTURER'S RECOMMENDATIONS ..... 134

**01 45 00**

**QUALITY CONTROL ..... 135**

**PART 1 - GENERAL ..... 135**

    1.01 RELATED DOCUMENTS AND PROVISIONS: ..... 135

    1.02 RELATED CODES:..... 135

    1.03 APPLICABLE CODES:..... 135

    1.04 OBSERVATION AND SUPERVISION: ..... 136

    1.05 TESTING AGENCIES: ..... 137

    1.06 TESTS AND INSPECTIONS: ..... 137

**PART 2 - PRODUCTS ..... 139**

    2.01 TYPE OF TEST AND INSPECTIONS:..... 139

**PART 3 - EXECUTION (NOT USED)..... 139**

**01 50 00**

**TEMPORARY FACILITIES AND CONTROLS ..... 140**

**PART 1 – GENERAL ..... 140**

- 1.01 RELATED DOCUMENTS AND PROVISIONS: ..... 140
- 1.02 TEMPORARY UTILITIES: ..... 140
- 1.03 CONSTRUCTION AIDS: ..... 142
- 1.04 BARRIERS AND ENCLOSURES: ..... 142
- 1.05 SECURITY: ..... 144
- 1.06 TEMPORARY CONTROLS: ..... 144
- 1.07 JOB SIGN(S): ..... 145
- 1.08 PUBLICITY RELEASES: ..... 146

**PART 2 – PRODUCTS (NOT USED) ..... 146**

**PART 3 – EXECUTION (NOT USED) ..... 146**

**01 50 13**

**CONSTRUCTION WASTE MANAGEMENT AND DISPOSAL ..... 147**

**PART 1 - GENERAL ..... 147**

- 1.01 RELATED DOCUMENTS AND PROVISIONS: ..... 147
- 1.02 SECTION INCLUDES: ..... 147
- 1.03 DEFINITIONS: ..... 147
- 1.04 PERFORMANCE REQUIREMENTS: ..... 148
- 1.05 SUBMITTALS: ..... 148
- 1.06 QUALITY ASSURANCE: ..... 149
- 1.07 WASTE MANAGEMENT PLAN: ..... 150

**PART 2 - PRODUCTS (NOT USED) ..... 151**

**PART 3 - EXECUTION ..... 151**

- 3.01 PLAN IMPLEMENTATION: ..... 151
- 3.02 RECYCLING CONSTRUCTION WASTE: ..... 152
- 3.03 DISPOSAL OF WASTE: ..... 153

**01 52 13**

**FIELD OFFICES ..... 155**

**PART 1 – GENERAL ..... 155**

- 1.01 RELATED DOCUMENTS AND PROVISIONS: ..... 155
- 1.02 SECTION INCLUDES: ..... 155
- 1.03 SUMMARY: ..... 155
- 1.04 SUBMITTALS: ..... 155
- 1.05 QUALITY ASSURANCE ..... 156
- 1.06 REGULATORY REQUIREMENTS ..... 156

<b>PART 2 – PRODUCTS .....</b>	<b>157</b>
2.01    FIELD OFFICE TRAILER .....	157
2.02    FIELD OFFICE TRAILER ITEMS .....	158
2.03    UTILITY AND SERVICES .....	160
2.04    FINISHES .....	160
<b>PART 3 – EXECUTION .....</b>	<b>161</b>
3.01    INSTALLATION.....	161
<b>01 60 00</b>	
<b>PRODUCT REQUIREMENTS.....</b>	<b>163</b>
<b>PART 1 - GENERAL .....</b>	<b>163</b>
1.01    RELATED DOCUMENTS:.....	163
<b>01 64 00</b>	
<b>OWNER-FURNISHED PRODUCTS.....</b>	<b>170</b>
<b>PART 1 – GENERAL .....</b>	<b>170</b>
1.01    RELATED DOCUMENTS AND PROVISIONS: .....	170
1.02    SECTION INCLUDES: .....	170
1.03    DEFINITIONS .....	170
1.04    PRODUCT DELIVERY, STORAGE, AND HANDLING:.....	170
<b>PART 2 – PRODUCTS .....</b>	<b>170</b>
2.01    GENERAL PRODUCT REQUIREMENTS:.....	170
2.02    FURNISHED MATERIALS AND EQUIPMENT .....	172
<b>PART 3 – EXECUTION .....</b>	<b>172</b>
3.01    INSTALLATION.....	172
3.02    CLEANING AND PROTECTION .....	173
<b>01 66 00 .....</b>	<b>174</b>
<b>PRODUCT DELIVERY, STORAGE AND HANDLING .....</b>	<b>174</b>
<b>PART 1 - GENERAL .....</b>	<b>174</b>
1.01    RELATED DOCUMENTS AND PROVISIONS .....	174
1.02    PRODUCTS.....	174
1.03    TRANSPORTATION AND HANDLING.....	174
1.04    STORAGE AND PROTECTION .....	174
<b>PART 2 – PRODUCTS (NOT USED) .....</b>	<b>175</b>
<b>PART 3 - EXECUTION (NOT USED).....</b>	<b>175</b>
<b>01 71 23</b>	

<b>FIELD ENGINEERING .....</b>	<b>176</b>
<b>PART 1 - GENERAL .....</b>	<b>176</b>
1.01    RELATED DOCUMENTS AND PROVISIONS: .....	176
1.02    REQUIREMENTS INCLUDED:.....	176
1.03    QUALIFICATIONS OF SURVEYOR OR ENGINEERS:.....	176
1.04    SURVEY REFERENCE POINTS: .....	176
1.05    RECORDS: .....	177
1.06    SUBMITTALS:.....	177
<b>PART 2 – PRODUCTS (NOT USED) .....</b>	<b>177</b>
<b>PART 3 - EXECUTION.....</b>	<b>177</b>
3.01    COMPLIANCE WITH LAWS: .....	177
3.02    NONCONFORMING WORK: .....	177
<b>01 73 00</b>	
<b>EXECUTION.....</b>	<b>178</b>
<b>PART 1 - GENERAL .....</b>	<b>178</b>
1.01    RELATED DOCUMENTS:.....	178
<b>01 73 29</b>	
<b>CUTTING AND PATCHING .....</b>	<b>191</b>
<b>PART 1 – GENERAL .....</b>	<b>191</b>
1.01    RELATED DOCUMENTS AND PROVISIONS: .....	191
1.02    CUTTING AND PATCHING:.....	191
1.03    SUBMITTALS:.....	192
1.04    QUALITY ASSURANCE: .....	193
1.05    PAYMENT FOR COSTS:.....	193
<b>PART 2 - PRODUCTS .....</b>	<b>193</b>
2.01    MATERIALS:.....	193
<b>PART 3 – EXECUTION .....</b>	<b>193</b>
3.01    INSPECTION: .....	193
3.02    PREPARATION: .....	194
3.03    ERECTION, INSTALLATION AND APPLICATION:.....	194
<b>01 76 00</b>	
<b>ALTERATION PROJECT PROCEDURES.....</b>	<b>196</b>
<b>PART 1 – GENERAL .....</b>	<b>196</b>
1.01    RELATED DOCUMENTS AND PROVISIONS:.....	196
<b>PART 2 - PRODUCTS .....</b>	<b>196</b>

2.01	PRODUCTS FOR PATCHING AND EXTENDING WORK: .....	196
<b>PART 3 - EXECUTION .....</b>		<b>196</b>
3.01	EXAMINATION: .....	196
3.02	PREPARATION: .....	196
3.03	INSTALLATION:.....	197
3.04	TRANSITIONS:.....	197
3.05	ADJUSTMENTS: .....	197
3.06	REPAIR OF DAMAGED SURFACES: .....	198
3.07	CULTIVATED AREAS AND OTHER SURFACE IMPROVEMENTS:.....	198
3.08	FINISHES: .....	198
3.09	CLEANING: .....	198
<b>01 78 23</b>		
<b>OPERATIONS AND MAINTENANCE DATA .....</b>		<b>199</b>
<b>PART 1 – GENERAL .....</b>		<b>199</b>
1.01	RELATED DOCUMENTS AND PROVISIONS: .....	199
1.02	QUALITY ASSURANCE: .....	199
1.03	FORMAT: .....	199
1.04	CONTENTS, EACH VOLUME: .....	200
1.05	MANUAL FOR MATERIALS AND FINISHES: .....	200
1.06	MANUAL FOR EQUIPMENT AND SYSTEMS: .....	201
1.07	SUBMITTAL:.....	202
<b>PART 2 – PRODUCTS (NOT USED) .....</b>		<b>202</b>
<b>PART 3 – EXECUTION (NOT USED) .....</b>		<b>202</b>
<b>01 78 36</b>		
<b>WARRANTIES.....</b>		<b>203</b>
<b>PART 1 - GENERAL .....</b>		<b>203</b>
1.01	RELATED DOCUMENTS AND PROVISIONS .....	203
1.02	FORMAT .....	203
1.03	PREPARATION: .....	203
1.04	TIME OF SUBMITTALS: .....	204
<b>PART 2 - PRODUCTS (NOT USED).....</b>		<b>204</b>
<b>PART 3 – EXECUTION (NOT USED) .....</b>		<b>204</b>
<b>01 78 39</b>		
<b>RECORD DOCUMENTS .....</b>		<b>205</b>
<b>PART 1 - GENERAL .....</b>		<b>205</b>
1.01	RELATED DOCUMENTS AND PROVISIONS: .....	205



<b>PART 2 PART 2 - RECORD DRAWINGS.....</b>	<b>205</b>
2.01    GENERAL: .....	205
2.02    RECORD DRAWING INFORMATION:.....	205
<b>PART 3 - RECORD SPECIFICATIONS.....</b>	<b>206</b>
3.01    GENERAL: .....	206
<b>PART 4 - MAINTENANCE OF RECORD DOCUMENTS.....</b>	<b>206</b>
4.01    GENERAL .....	206
<b>PART 5 – PRODUCTS (NOT USED).....</b>	<b>207</b>
<b>01 79 00</b>	
<b>DEMONSTRATION AND TRAINING.....</b>	<b>208</b>
<b>PART 1 - GENERAL .....</b>	<b>208</b>
1.01    RELATED DOCUMENTS:.....	208
1.02    DEMONSTRATION AND TRAINING VIDEO RECORDINGS .....	216

## **SUMMARY OF WORK**

### **PART 1 - GENERAL**

#### **1.01 RELATED DOCUMENTS AND PROVISIONS, AND CONFLICTS:**

If any provision in these Division 01 specifications conflicts with any provision in the other Contract Documents, then the provision in the other Contract Document shall control.

All Contract Documents (see General Conditions §1.1.1) should be reviewed for applicable provisions related to the provisions in this document, including without limitation General Conditions and Agreement.

#### **1.02 SUMMARY OF WORK COVERED BY CONTRACT DOCUMENTS**

The Work of this Contract consists of the following:

Various Sites – Door Entry Systems Group 5 Project No 23126 –

The Scope of work to include Installation of AIPhone door entry intercom systems at various sites. Sites: Oakland Tech Upper Campus, Montera Middle School, Jefferson CDC, Hillcrest Elementary School, & Bella Vista CDC.

Various Sites – Door Entry Systems Group 6 Project No 23127-

The Scope of work to include Installation of AIPhone door entry intercom systems at various sites. Sites: Thornhill Elementary School, Oakland Academy of Knowledge, Lockwood Steam Academy, Lockwood CDC, & Kaiser Early Childhood Center.

#### **1.03 CONTRACTS**

Contractor will perform the Work under a single, fixed-price competitively bid Contract.

#### **1.04 WORK BY OTHERS**

A. Work on the Project that will be performed and completed prior to the start of the Work of this Contract:

(1) \_\_\_\_\_

B. Work on the Project that will be performed by others concurrent with the Work of this Contract:

(1) \_\_\_\_\_

(2) \_\_\_\_\_

## **1.05 CODES, REGULATIONS, AND STANDARDS**

- A. The codes, regulations, and standards adopted by the state and federal agencies having jurisdiction shall govern minimum requirements for this project. Where codes, regulations, and standards conflict with the Contract Documents, these conflicts shall be brought to the immediate attention of the Owner and the Architect.
- B. Codes, regulations, and standards shall be as published effective as of date of bid opening, unless otherwise specified or indicated.

## **1.06 PROJECT RECORD DOCUMENTS:**

- A. Contractor shall maintain on Site one set of the following record documents; Contractor shall record actual revisions to the Work:
  - (1) Record Drawings.
  - (2) Specifications.
  - (3) Addenda.
  - (4) Change Orders and other modifications to the Contract.
  - (5) Reviewed shop drawings, product data, and samples.
  - (6) Field test records.
  - (7) Inspection certificates.
  - (8) Manufacturer's certificates.
- B. Contractor shall store Record Documents separate from documents used for construction. Provide files, racks, and secure storage for Record Documents and samples.
- C. Contractor shall record information concurrent with construction progress.
- D. Specifications: Contractor shall legibly mark and record at each product section of the Specifications the description of the actual product(s) installed, including the following:
  - (1) Manufacturer's name and product model and number.
  - (2) Product substitutions or alternates utilized.
  - (3) Changes made by Addenda and Change Orders and written directives.

## **1.07 EXAMINATION OF EXISTING CONDITIONS**

- A. Contractor shall be held to have examined the Project Site and acquainted itself with the conditions of the Site or of the streets or roads approaching the Site.
- B. Prior to commencement of Work, Contractor shall survey the Site and existing buildings and improvements to observe existing damage and defects such as cracks, sags, broken, missing or damaged glazing, other building elements and Site improvements, and other damage.
- C. Should Contractor observe cracks, sags, and other damage to and defects of the Site and adjacent buildings, paving, and other items not indicated in the Contract Documents, Contractor shall immediately report same to the Owner and the Architect.

## **1.08 CONTRACTOR'S USE OF PREMISES**

- A. Contractor shall have use of the premises for the execution of the Work.
- B. Coordinate use of the premises under the direction of the Owner.
- C. If unoccupied and only with Owner's prior written approval, Contractor may use the building(s) at the Project Site without limitation for its operations, storage, and office facilities for the performance of the Work, provided, however, that Contractor shall adhere to any limitations or restrictions set forth by Owner in its written approval for use of the building(s). If the Owner chooses to beneficially occupy any building(s), Contractor must obtain the Owner's written approval for Contractor's use of spaces and types of operations to be performed within the building(s) while so occupied. Contractor's access to the building(s) shall be limited to the areas indicated.

If the space at the Project Site is not sufficient for Contractor's operations, storage, office facilities and/or parking, Contractor shall arrange and pay for any additional facilities needed by Contractor.

- D. Contractor shall not interfere with use of or access to occupied portions of the building(s) or adjacent property.
- E. Contractor shall maintain corridors, stairs, halls, and other exit-ways of building clear and free of debris and obstructions at all times.
- F. No one other than those directly involved in the demolition and construction, or specifically designated by the Owner or the Architect shall be permitted in the areas of work during demolition and construction activities.
- G. The Contractor shall install the construction security fence and maintain that it will be locked when not in use. Keys to this fencing will be provided to the Owner.

## **1.09 PROTECTION OF EXISTING STRUCTURES AND UTILITIES**

- A. The Drawings show above-grade and below-grade structures, utility lines, and other installations that are known or believed to exist in the area of the Work. Contractor shall locate these existing installations before proceeding with excavation and other operations that could damage same; maintain them in service, where appropriate; and repair damage to them caused by the performance of the Work. Should damage occur to these existing installations, the costs of repair shall be at the Contractor's expense and made to the Owner's satisfaction.
- B. Contractor shall be alert to the possibility of the existence of additional structures and utilities. If Contractor encounters additional structures and utilities, Contractor will immediately report to the Owner for disposition of same as indicated in the General Conditions.

## **1.10 UTILITY SHUTDOWNS AND INTERRUPTIONS**

- A. Contractor shall give the Owner a minimum of three (3) days written notice in advance of any need to shut off existing utility services or to effect equipment interruptions. The Owner will set exact time and duration for shutdown, and will assist Contractor with shutdown. Work required to re-establish utility services shall be performed by the Contractor.
- B. Contractor shall obtain Owner's written approval in advance of deliveries of material or equipment or other activities that may conflict with Owner's use of the building(s) or adjacent facilities.

## **1.11 STRUCTURAL INTEGRITY**

- A. Contractor shall be responsible for and supervise each operation and work that could affect structural integrity of various building elements, both permanent and temporary.
- B. Contractor shall include structural connections and fastenings as indicated or required for complete performance of the Work.

## **PART 2 – PRODUCTS (Not Used)**

## **PART 3 – EXECUTION (Not Used)**

END OF SECTION

## **ALLOWANCES**

### **PART 1 - GENERAL**

#### **1.01 RELATED DOCUMENTS AND PROVISIONS:**

All Contract Documents should be reviewed for applicable provisions related to the provisions in this document, including without limitation the Agreement and General Conditions § 3.8.

- A. General Conditions;
- B. Special Conditions.

#### **1.02 SUMMARY:**

- A. Section includes administrative and procedural requirements governing allowances.
  - (1) Certain items are specified in the Contract Documents by allowances. Allowances have been established in lieu of additional requirements and to defer selection of actual materials and equipment to a later date when direction will be provided to Contractor by Owner. If necessary, additional requirements will be issued by Change Order.
- B. Types of allowances include the following:
  - (1) Unit-cost allowances.
  - (2) Specific scope allowances.
  - (3) General contingency allowances.
- C. Related Requirements:
  - (1) Section 01 22 00 "Alternatives and Unit Pricing" for procedures for using unit prices.
  - (2) Section 01 40 00 "Quality Requirements" for procedures governing the use of allowances for testing and inspecting.

#### **1.03 SELECTION AND PURCHASE:**

- A. At the earliest practical date after award of the Contract, advise Architect of the date when final selection and purchase of each product or system described by an allowance must be completed to avoid delaying the Work.

- B. At Architect's request, obtain proposals for each allowance for use in making final selections. Include recommendations that are relevant to performing the Work.
- C. Purchase products and systems selected by Architect from the designated supplier.

**1.04 ACTION SUBMITTALS:**

- A. Submit proposals for purchase of products or systems included in allowances, in the form specified for Change Orders.

**1.05 INFORMATIONAL SUBMITTALS:**

- A. Submit invoices or delivery slips to show actual quantities of materials delivered to the site for use in fulfillment of each allowance.
- B. Submit time sheets and other documentation to show labor time and cost for installation of allowance items that include installation as part of the allowance.
- C. Coordinate and process submittals for allowance items in same manner as for other portions of the Work.

**1.06 COORDINATION:**

- A. Coordinate allowance items with other portions of the Work. Furnish templates as required to coordinate installation.

**1.07 UNIT-COST ALLOWANCES:**

- A. Allowance shall include cost to Contractor of specific products and materials ordered by Owner or selected by Architect under allowance and shall include taxes, freight, and delivery to Project site.
- B. Unless otherwise indicated, Contractor's costs for receiving and handling at Project site, labor, installation, overhead and profit, and similar costs related to products and materials ordered by Owner under allowance shall be included as part of the Contract Sum and not part of the allowance.
- C. Unused Materials: Return unused materials purchased under an allowance to manufacturer or supplier for credit to Owner, after installation has been completed and accepted.
  - (1) If requested by Architect, retain and prepare unused material for storage by Owner. Deliver unused material to Owner's storage space as directed.
- D. At Project closeout, credit unused amounts remaining in the unit-cost allowance to Owner.

## **1.08 SPECIAL AND GENERAL (CONTINGENCY) ALLOWANCES:**

- A. Use an allowance only as directed by Owner.
- B. Contractor's overhead, profit, and related costs for products and equipment ordered by Owner under an allowance are included in the allowance. These costs include delivery, installation, taxes, insurance, equipment rental, and similar costs.
- C. Authorization of use of funds from the allowance will include Contractor's related costs and reasonable overhead and profit margins, per Article 7 of the General Conditions. Contractor must sign an expenditure approval form.
- D. An allowance may only be increased by a change order approved by the owner's governing body. At Project closeout, credit unused amounts remaining in an allowance to Owner.

## **1.09 ADJUSTMENT OF ALLOWANCES:**

- A. Allowance Adjustment: To request payment from an allowance, Contractor must comply with all requirements in Section 4.5 in the General Conditions. Owner has sole discretion whether to issue a change order or authorize payment from an allowance. Any time extension must be granted by change order. If an allowance is fully spent, then a change order must be used. To adjust allowance amounts, prepare an expenditure approval based on the difference between purchase amount and the allowance. If applicable, include reasonable allowances for cutting losses, tolerances, mixing wastes, normal product imperfections, and similar margins.
  - (1) Include installation costs in purchase amount only where indicated as part of the allowance.
  - (2) If requested, prepare explanation and documentation to substantiate distribution of overhead costs and other margins claimed.
  - (3) Submit substantiation of a change in scope of work, if any, claimed in Change Orders related to unit-cost allowances.
  - (4) Owner reserves the right to establish the quantity of work-in-place by independent quantity survey, measure, or count.
- B. Submit claims for increased costs because of a change in scope or nature of the allowance described in the Contract Documents, whether for the purchase order amount or Contractor's handling, labor, installation, overhead, and profit.
  - (1) Do not include Contractor's or subcontractor's indirect expense in the Change Order cost amount unless it is clearly shown that the nature or



extent of work has changed from what could have been foreseen from information in the Contract Documents.

- (2) No change to Contractor's indirect expense is permitted for selection of higher- or lower-priced materials or systems of the same scope and nature as originally indicated.

**PART 2 – PRODUCTS (Not Used)**

**PART 3 – EXECUTION**

**3.01 EXAMINATION:**

- A. Examine products covered by an allowance promptly on delivery for damage or defects. Return damaged or defective products to manufacturer for replacement.

**3.02 PREPARATION:**

- A. Coordinate materials and their installation for each allowance with related materials and installations to ensure that each allowance item is completely integrated and interfaced with related work.

**3.03 [Not Used]**

END OF SECTION

## **ALTERNATES AND UNIT PRICING**

### **PART 1 – ALTERNATES**

#### **1.01 RELATED DOCUMENTS AND PROVISIONS:**

All Contract Documents should be reviewed for applicable provisions related to the provisions in this document.

#### **1.02 DESCRIPTION**

The items of work indicated below propose modifications to, substitutions for, additions to and/or deletions from the various parts of the Work specified in other Sections of the Specifications. The acceptance or rejection of any of the alternates is strictly at the option of the Owner subject to Owner's acceptance of Contractor's stated prices contained in this Proposal.

#### **1.03 GENERAL**

Where an item is omitted, or scope of Work is decreased, all Work pertaining to the item whether specifically stated or not, shall be omitted and where an items is added or modified or where scope of Work is increased, all Work pertaining to that required to render same ready for use on the Project in accordance with intention of Drawings and Specifications shall be included in an agreed upon price amount.

#### **1.04 BASE BID**

The Base Bid includes all work required to construct the Project completely and in accordance with the Contract Documents.

#### **1.05 ALTERNATES**

**[FILL IN OR MODIFY TO MATCH THE BID FORM AND AGREEMENT § 1]**

A. [Alternate 1 Description]

(1) ADD \_\_\_\_\_  
(written amount)

Dollars (\$\_\_\_\_\_.\_\_\_\_)

(2) SUBTRACT \_\_\_\_\_  
(written amount)

Dollars (\$\_\_\_\_\_.\_\_\_\_)

B. [Unit Price Alternate 2 Description, include estimated quantity]

(1) ADD unit price of \_\_\_\_\_  
(written amount)

Dollars (\$\_\_\_\_\_.\_\_); and total price of \_\_\_\_\_ Dollars (\$\_\_\_\_\_.\_\_).

(2) SUBTRACT unit price of \_\_\_\_\_  
(written amount)

Dollars (\$\_\_\_\_\_.\_\_); and total price of \_\_\_\_\_ Dollars (\$\_\_\_\_\_.\_\_).

The above Alternate descriptions are general in nature and for reference purposes only. The Contract Documents, including, without limitation, the Drawings and Specifications, must be referred to for the complete scope of Work.

## **PART 2 - UNIT PRICING**

### **2.01 GENERAL**

Contractor shall completely state all required figures based on Unit Prices listed below. Where scope of Work is decreased, all Work pertaining to the item, whether specifically stated or not, shall be omitted and where scope of Work is increased, all work pertaining to that item required to render same ready for use on the Project in accordance with intention of Drawings and Specifications shall be included in an agreed upon price amount.

### **2.02 UNIT PRICES**

Based on the estimated quantities, furnish unit prices for each of the named items on a square foot, lineal foot, or per each basis, as applies. Unit prices shall include all labor, materials, services, profit, overhead, insurance, bonds, taxes, and all other incidental costs of Contractor, subcontractors, and supplier(s).

END OF SECTION

## **PRODUCT OPTIONS AND SUBSTITUTIONS**

### **PART 1 - GENERAL**

#### **1.01 RELATED DOCUMENTS AND PROVISIONS**

All Contract Documents should be reviewed for applicable provisions related to the provisions in this document, including without limitation:

- A. Instructions to Bidders; and
- B. General Conditions.

#### **1.02 SUBSTITUTIONS OF MATERIALS AND EQUIPMENT (See General Conditions § 3.11):**

- A. Catalog numbers and specific brands or trade names followed by the designation "or equal" are used in conjunction with material and equipment required by the Specifications to establish the standards of quality, utility, and appearance required. Substitutions which are equal in quality, utility, and appearance to those specified may be reviewed subject to the provisions of the General Conditions.
- B. Wherever more than one manufacturer's product is specified, the first-named product is the basis for the design used in the Work and the use of alternative-named manufacturers' products or substitutes may require modifications in that design. If such alternatives are proposed by Contractor and are approved by the Owner and/or the Architect, Contractor shall assume all costs required to make necessary revisions and modifications of the design resulting from the substitutions requested by the Contractor.
- C. When materials and equipment are specified by first manufacturer's name and product number, second manufacturer's name and "or approved equal," supporting data for the second product, if proposed by Contractor, shall be submitted in accordance with the requirements for substitutions.
- D. If the Owner and/or Architect, in reviewing proposed substitute materials and equipment, require revisions or corrections to be made to previously accepted Shop Drawings and supplemental supporting data to be resubmitted, Contractor shall promptly do so. If any proposed substitution is judged by the Owner and/or Architect to be unacceptable, the specified material or equipment shall be provided.

- E. Samples may be required. Tests required by the Owner and/or Architect for the determination of quality and utility shall be made at the expense of Contractor, with acceptance of the test procedure first given by the Owner.
- ~~F.~~ In reviewing the supporting data submitted for substitutions, the Owner and/or Architect will use for purposes of comparison all the characteristics of the specified material or equipment as they appear in the manufacturer's published data even though all the characteristics may not have been particularly mentioned in the Contract Documents.

**PART 2 – PRODUCTS (Not Used)**

**PART 3 – EXECUTION (Not Used)**

END OF SECTION

**PAYMENT AND CONDITIONAL AND UNCONDITIONAL  
WAIVER AND RELEASE FORMS**

**1.01. GENERAL INFORMATION**

Contractor shall comply with all provisions in the Contract Documents related to payments and requests for changes in contract price, especially General Conditions Articles 4, 7, and 9.

**1.02. MAKING PAYMENT**

The owner should make payment directly to the Contractor. Payment should not be made to any other party unless specifically indicated on this form.

**CONDITIONAL WAIVER AND RELEASE  
ON PROGRESS PAYMENT  
(Civil Code Section 8132)**

NOTICE: THIS DOCUMENT WAIVES THE CLAIMANT'S LIEN, STOP PAYMENT NOTICE, AND PAYMENT BOND RIGHTS EFFECTIVE ON RECEIPT OF PAYMENT. A PERSON SHOULD NOT RELY ON THIS DOCUMENT UNLESS SATISFIED THAT THE CLAIMANT HAS RECEIVED PAYMENT.

Name of Claimant: \_\_\_\_\_

Name of Customer: \_\_\_\_\_

Job Location: \_\_\_\_\_

Owner: \_\_\_\_\_

Through Date: \_\_\_\_\_

**Conditional Waiver and Release**

This document waives and releases lien, stop payment notice, and payment bond rights the claimant has for labor and service provided, and equipment and material delivered, to the customer on this job through the Through Date of this document. Rights based upon labor or service provided, or equipment or material delivered, pursuant to a written change order that has been fully executed by the parties prior to the date that this document is signed by the claimant, are waived and released by this document, unless listed as an Exception below. This document is effective only on the claimant's receipt of payment from the financial institution on which the following check is drawn:

Maker of Check: \_\_\_\_\_

Amount of Check: \$\_\_\_\_\_

Check Payable to: \_\_\_\_\_

**Exceptions**

This document does not affect any of the following:

- (1) Retentions.
- (2) Extras for which the claimant has not received payment.
- (3) The following progress payments for which the claimant has previously given a conditional waiver and release but has not received payment:

Date(s) of waiver and release: \_\_\_\_\_

Amount(s) of unpaid progress payment(s): \$\_\_\_\_\_

- (4) Contract rights, including (A) a right based on rescission, abandonment, or breach of contract, and (B) the right to recover compensation for work not compensated by the payment.

Claimant's Signature: \_\_\_\_\_

Claimant's Title: \_\_\_\_\_

Date of Signature: \_\_\_\_\_



**UNCONDITIONAL WAIVER AND RELEASE  
ON PROGRESS PAYMENT  
(Civil Code Section 8134)**

**NOTICE TO CLAIMANT:** THIS DOCUMENT WAIVES AND RELEASES LIEN, STOP PAYMENT NOTICE, AND PAYMENT BOND RIGHTS UNCONDITIONALLY AND STATES THAT YOU HAVE BEEN PAID FOR GIVING UP THOSE RIGHTS. THIS DOCUMENT IS ENFORCEABLE AGAINST YOU IF YOU SIGN IT, EVEN IF YOU HAVE NOT BEEN PAID. IF YOU HAVE NOT BEEN PAID, USE A CONDITIONAL WAIVER AND RELEASE FORM.

Name of Claimant: \_\_\_\_\_

Name of Customer: \_\_\_\_\_

Job Location: \_\_\_\_\_

Owner: \_\_\_\_\_

Through Date: \_\_\_\_\_

**Unconditional Waiver and Release**

This document waives and releases lien, stop payment notice, and payment bond rights the claimant has for labor and service provided, and equipment and material delivered, to the customer on this job through the Through Date of this document. Rights based upon labor or service provided, or equipment or material delivered, pursuant to a written change order that has been fully executed by the parties prior to the date that this document is signed by the claimant, are waived and released by this document, unless listed as an Exception below. The claimant has received the following progress payment: \$ \_\_\_\_\_

**Exceptions**

This document does not affect any of the following:

- (1) Retentions.
- (2) Extras for which the claimant has not received payment.
- (3) Contract rights, including (A) a right based on rescission, abandonment, or breach of contract, and (B) the right to recover compensation for work not compensated by the payment.

Claimant's Signature: \_\_\_\_\_

Claimant's Title: \_\_\_\_\_

Date of Signature: \_\_\_\_\_

{SR555211}

**PAYMENT AND  
CONDITIONAL AND UNCONDITIONAL WAIVER AND  
RELEASE FORMS  
DOCUMENT 01 29 00-28**

**CONDITIONAL WAIVER AND RELEASE  
ON FINAL PAYMENT  
(Civil Code Section 8136)**

**NOTICE:** THIS DOCUMENT WAIVES THE CLAIMANT'S LIEN, STOP PAYMENT NOTICE, AND PAYMENT BOND RIGHTS EFFECTIVE ON RECEIPT OF PAYMENT. A PERSON SHOULD NOT RELY ON THIS DOCUMENT UNLESS SATISFIED THAT THE CLAIMANT HAS RECEIVED PAYMENT.

Name of Claimant: \_\_\_\_\_

Name of Customer: \_\_\_\_\_

Job Location: \_\_\_\_\_

Owner: \_\_\_\_\_

**Conditional Waiver and Release**

This document waives and releases lien, stop payment notice, and payment bond rights the claimant has for labor and service provided, and equipment and material delivered, to the customer on this job. Rights based upon labor or service provided, or equipment or material delivered, pursuant to a written change order that has been fully executed by the parties prior to the date that this document is signed by the claimant, are waived and released by this document, unless listed as an Exception below. This document is effective only on the claimant's receipt of payment from the financial institution on which the following check is drawn:

Maker of Check:

Amount of Check: \$ \_\_\_\_\_

Check Payable to: \_\_\_\_\_

**Exceptions**

This document does not affect any of the following: \_\_\_\_\_

Disputed claims for extras in the amount of: \$ \_\_\_\_\_

Claimant's Signature: \_\_\_\_\_

Claimant's Title: \_\_\_\_\_

Date of Signature: \_\_\_\_\_

**UNCONDITIONAL WAIVER AND RELEASE  
ON FINAL PAYMENT  
(Civil Code Section 8138)**

**NOTICE TO CLAIMANT:** THIS DOCUMENT WAIVES AND RELEASES LIEN, STOP PAYMENT NOTICE, AND PAYMENT BOND RIGHTS UNCONDITIONALLY AND STATES THAT YOU HAVE BEEN PAID FOR GIVING UP THOSE RIGHTS. THIS DOCUMENT IS ENFORCEABLE AGAINST YOU IF YOU SIGN IT, EVEN IF YOU HAVE NOT BEEN PAID. IF YOU HAVE NOT BEEN PAID, USE A CONDITIONAL WAIVER AND RELEASE FORM.

Name of Claimant: \_\_\_\_\_

Name of Customer: \_\_\_\_\_

Job Location: \_\_\_\_\_

Owner: \_\_\_\_\_

**Unconditional Waiver and Release**

This document waives and releases lien, stop payment notice, and payment bond rights the claimant has for all labor and service provided, and equipment and material delivered, to the customer on this job. Rights based upon labor or service provided, or equipment or material delivered, pursuant to a written change order that has been fully executed by the parties prior to the date that this document is signed by the claimant, are waived and released by this document, unless listed as an Exception below. The claimant has been paid in full.

**Exceptions**

This document does not affect any of the following: \_\_\_\_\_

Disputed claims for extras in the amount of: \$\_\_\_\_\_

Claimant's Signature: \_\_\_\_\_

Claimant's Title: \_\_\_\_\_

Date of Signature: \_\_\_\_\_

## **ADMINISTRATIVE REQUIREMENTS**

### **PART 1 - GENERAL**

#### **1.01 SUMMARY:**

- A. This section described general procedural requirements for ongoing submittals.
  - (1) Construction progress schedules.
  - (2) Schedule of values.
  - (3) Product data and manufacturers' literature.
  - (4) Shop drawings.
  - (5) Samples.
  - (6) Manufacturers' certificates.
  - (7) Excess materials and attic stock.
- B. Related Requirements.
  - (1) Section 01 40 00: Test reports, manufacturer's field reports, and mock-ups.
  - (2) Section 01 77 00: Closeout requirements including Project Record Documents.
  - (3) Section 01 78 36: Warranties.

#### **1.02 GENERAL SUBMITTAL PROCEDURES (see General Conditions § 3.11):**

- A. Submittals: Transmit each item using form approved by Architect; submit sample to Architect and Owner for approval prior to use.
  - (1) Identify Project, Contractor, subcontractor, major supplier.
    - (a) Attach sequential identification number for each new submittal.
    - (b) Identify each resubmittal using original submittal number and sequential identification clearly indicating item is resubmitted.
  - (2) Identify pertinent Drawing sheet and detail number, and Specification section number as appropriate.

- (3) Identify deviations from Contract Documents.
- (4) Provide space for Contractor and Architect review stamps.
- (5) Contractor: Review and stamp submittals from subcontractors prior to submitting to Architect, and Owner
  - (a) Review submittals and indicate where conflicts occur with Contract Documents and with work of other subcontractors.
  - (b) Return submittals that vary significantly from Contract Documents for correction and resubmittal prior to submitting to Architect and Owner. Submittals that vary significantly from Contract Documents and that fail to indicate thorough Contractor review prior to submission to Architect and Owner will be returned without review.
  - (c) Cursory review and stamping of subcontractor submittal by Contractor shall not be acceptable.
- B. Initial Schedules: Submit initial progress schedule and schedule of value in duplicate within 7 working days after award of Contract.
  - (1) After review by Owner and Architect revise and resubmit where required.
- C. Comply with progress schedule for submittals related to Work progress. Coordinate submittal of related items.
- D. After Owner and Architect review of submittal, revise and resubmit as required, identify changes made since previous submittal.
- E. Distribute copies of reviewed submittals to concerned persons. Instruct recipients to promptly report any inability to comply.

### **1.03 TYPES OF SUBMITTALS:**

- A. General: Project requires various types of submittals to maintain communications, minimize misunderstandings, avoid unnecessary conflicts, and to ensure complete documentation for Project Record Documents.
  - (1) Maintain complete set of submittals including required revisions.
- B. Construction Schedules: Submit construction progress schedules for Design Team and Owner review and to maintain entire team up-to-date on construction activities.

- C. Schedule of Values: Submit schedule of values indicating division of Work, subcontractors to perform work, products being used, and values attributed to each to inform Design Team and Owner.
- D. Action Submittals: Submittals relating to product data and manufacturer's literature, shop drawings, and samples for Owner review and comment; do not begin fabrication, delivery, or installation until Owner review is complete.
- E. Information Submittals: Submittals relating to certifications, qualifications, reports, including test reports, and instructions are for information; Owner may choose to comment but action is not generally anticipated.
  - (1) Manufacturer installation instructions and recommendations shall be considered information submittals.
- F. Design/Build Submittals: Where portion of Work requires design by specialized professionals, submit information necessary to ensure work complies with Contract Documents along with certifications signed by qualified professional.
  - (1) Calculations: Do not submit calculations unless specifically required by Contract Documents; submit calculations required by applicable authorities directly to applicable authorities.
    - (a) Submit certification by qualified professional indicating required calculations have been prepared and work conforms to Contract Documents and applicable codes and regulations.
- G. Maintenance Materials Submittals: Compile maintenance information and materials during Work to ensure complete set of documents, maintenance manuals, and operation instructions.
- H. Closeout Submittals: Compile closeout submittals, organize, and submit to Owner prior to or at time of Completion. Project will not be considered Complete until closeout submittals have been received by Owner.

**1.04 CONSTRUCTION PROGRESS SCHEDULES (see General Conditions § 3.9):**

- A. Submit construction progress schedule with separate item for each major trade and operation, identifying first day of each week.
  - (1) Show complete sequence of construction by activity, identifying work of separate stages and logically grouped activities.
  - (2) Show projected percentage of completion for each item of Work as of time of each application for payment.

- (3) “Submittal Schedule”: Show Contractor submittal dates required for shop drawings, product data, and samples, and product delivery dates; deliver to Architect and Owner per approved “Submittal Schedule.”
  - (a) “Submittal Schedule” may be incorporated into construction progress schedule or may be separate, Contractor option.
  - (b) Review Period: Architect and Owner will be expedient in review however, Contractor shall schedule submittals recognizing possibility Architect may reject and may require resubmittal.
  - (c) Contract extension shall not be allowed for Contractor’s failure to properly schedule submittals to allow for Architect requiring resubmittal.
- B. Progress Schedule Format: The schedule and updates shall conform, at a minimum, to industry standards for (a) critical path scheduling and (b) facilitation of Owner’s project management and evaluation of Contractor Claims for additional money or time.
  - (1) Submit revised progress schedules with each application for payment reflecting changes since previous submittal, not less than monthly.

**1.05 SCHEDULE OF VALUES:**

- A. Submit typed schedule on AIA Form G703 or another Owner and Architect pre-approved 8-1/2" by 11" paper format; Contractor's standard media-driven printout will be considered on request. Submit within 15 days after award of Contract.
- B. Format: Table of Contents of this Project Manual, with modifications as pre-approved by Owner and Architect; identify each line item with number and title of major specification sections.
- C. Include in each line item a directly proportional amount of Contractor overhead and profit.
- D. Revise schedule to list change orders for each application for payment.

**1.06 PRODUCT DATA/MANUFACTURERS’ LITERATURE (see General Conditions § 3.11):**

- A. Action Submittals: Mark each copy to identify applicable Products, models, options, and other data; supplement manufacturers' standard data to provide information unique to the Work.
- B. Information Submittals: Contractor shall obtain and furnish to the Owner three (3) complete sets of manuals containing the manufacturers’ instructions for maintenance and operation of each item of equipment and apparatus furnished



under the Contract Documents and any additional data specifically requested under the various sections of the specifications for each division of the Work.

Maintain copy of manufacturer installation instructions and recommendations in Contractor's field office for review.

- C. Product data shall be submitted as electronic PDF files unless otherwise noted or approved by Architect and Owner in advance.
  - (1) Where paper copies are permitted submit number of copies Contractor requires, plus two copies to be retained by Architect and Owner.

**1.07 SHOP DRAWINGS (see General Conditions § 3.11):**

- A. Shop drawings shall be submitted as designated in the General Conditions.

**1.08 SAMPLES:**

- A. Submit full range of manufacturers' standard colors, textures, and patterns for Architect's and Owner's selection.
- B. Submit samples to illustrate functional characteristics of product, with integral parts and attachment devices.
- C. Coordinate submittal of different categories for interfacing work. Include identification on each sample, giving full information.
- D. Submit number of samples required by Contractor plus two to be retained by Architect and Owner.
  - (1) Maintain one set of approved samples at Project Field office.
- E. Sizes: Provide following sizes unless otherwise specified.
  - (1) Flat or Sheet Products: Minimum 6" square, maximum 12" by 12".
  - (2) Linear Products: Minimum 6", maximum 12" long.
  - (3) Bulk Products: Minimum one pint, maximum one gallon.
- F. Full size samples may be used in the Work upon approval.

**1.09 MANUFACTURER'S CERTIFICATES:**

- A. Submit certificates, in duplicate in accordance with requirements of each Specification section.

**1.10 EXCESS MATERIALS AND ATTIC STOCK**

- A. Excess Materials: Excess materials shall be considered property of Owner; inform Owner of extent of excess materials and methods required for handling and storage; remove from site excess materials not required by Owner for maintenance stock.
- B. Attic Stock: Owner may choose to obtain additional attic stock for maintenance purposes where excess materials are not considered adequate.
  - (1) Owner may require as much as 5% extra materials for maintenance purposes. Exact amount of each material shall be determined by Owner based on following meeting and additional costs determined by Contractor.
    - (a) Contractor shall be prepared to order up to 5% extra materials on items that may not be readily available in future such as custom colors, off-shore manufacture, anticipated life span under 5 years, and potential for damage.
      - 1) Do not order extra attic stock until extent is determined and agreed to by Owner including which materials require extra stock and exactly how much those materials will cost including shipping and handling.
    - (b) Excess Materials: Furnish excess materials only for materials that have a shelf-life of more than three years.
  - (2) Meeting: Conduct meeting prior to beginning Work to discuss extent of materials Owner would like to receive at project closeout for attic stock for maintenance materials; where available include personnel from Owner's maintenance crew.
    - (a) Estimate amount of excess materials to be anticipated to be ordered in addition to materials for handling and storage and how those materials will be invoiced and identified regarding material and location in Project. Determine area necessary for adequate storage, handling, and identifying excess materials and attic stock and discuss with Owner.
    - (b) Submit information regarding equipment necessary for handling of excess materials and attic stock due to weight, size, and storage requirements.
    - (c) Assist Owner in determining where on-site or off-site additional attic stock for maintenance purposes will be delivered and stored.
  - (3) Additional Costs: After meeting submit to Owner detailed listing of additional costs for each material Owner may like to receive for attic stock and assist Owner in modifying listing to determine acceptable final costs.

- (a) Include unit prices for desired attic stock where excess materials are not adequate for Owner maintenance stock.
- (4) Final Completion: Ensure attic stock has been received, identified, cataloged, and stored at locations agreed upon with Owner based on Change Order indicating amounts finally agreed to by Owner.

END OF SECTION

## **PROJECT MANAGEMENT AND COORDINATION**

### **PART 1 - GENERAL**

#### **1.01 RELATED DOCUMENTS:**

- A. See all Contract Documents, including General and Supplementary Conditions and other Division 01 Specifications.

#### **1.02 SUMMARY:**

- A. Section includes administrative provisions for coordinating construction operations on Project including, but not limited to, the following:
  - (1) General coordination procedures.
  - (2) Coordination drawings.
  - (3) Requests for Information (RFIs).
  - (4) Project web site.
  - (5) Project meetings.
  - (6) Web-Based Project Information Management System (PIM)
- B. Each contractor shall participate in coordination requirements. Certain areas of responsibility are assigned to a specific contractor.
- C. Related requirements:
  - (1) Section 01 32 00 "Construction Progress Documentation" for preparing and submitting Contractor's construction schedule.
  - (2) Section 01 73 00 "Execution" for procedures for coordinating general installation and field-engineering services, including establishment of benchmarks and control points.
  - (3) Section 01 77 00 "Contract Closeout and Final Cleaning" for coordinating closeout of the Contract.

#### **1.03 DEFINITIONS:**

- A. RFI: Request from Owner, Architect, or Contractor seeking information required by or clarifications of the Contract Documents.
- B. DSA: Division of the State Architect: The governing agency for the Project.

- C. PIM: Web-Based Project Information Management System.

#### **1.04 INFORMATIONAL SUBMITTALS:**

- A. Subcontract List: Prepare a written summary identifying individuals or firms proposed for each portion of the Work, including those who are to furnish products or equipment fabricated to a special design. Include the following information in tabular form:
  - (1) Name, address, and telephone number of entity performing subcontract or supplying products.
  - (2) Number and title of related Specification Section(s) covered by subcontract.
  - (3) Drawing number and detail references, as appropriate, covered by subcontract.
  
- B. Key Personnel Names: Within 7 days of starting construction operations, submit a list of key personnel assignments, including superintendent and other personnel in attendance at Project site. Identify individuals and their duties and responsibilities; list addresses and telephone numbers, including home, office, and cellular telephone numbers and e-mail addresses. Provide names, addresses, and telephone numbers of individuals assigned as alternates in the absence of individuals assigned to Project.
  - (1) Post copies of list in project meeting room, in temporary field office, on Project Web site (PIM), and by each temporary telephone. Keep list current at all times.

#### **1.05 GENERAL COORDINATION PROCEDURES:**

- A. Coordination: Coordinate construction operations included in different Sections of the Specifications to ensure efficient and orderly installation of each part of the Work. Coordinate construction operations, included in different Sections, that depend on each other for proper installation, connection, and operation.
  - (1) Schedule construction operations in sequence required to obtain the best results where installation of one part of the Work depends on installation of other components, before or after its own installation.
  - (2) Coordinate installation of different components to ensure maximum performance and accessibility for required maintenance, service, and repair.
  - (3) Make adequate provisions to accommodate items scheduled for later installation.

- B. Coordination: Each contractor shall coordinate its construction operations with those of other contractors and entities to ensure efficient and orderly installation of each part of the Work. Each contractor shall coordinate its operations with operations, included in different sections, that depend on each other for proper installation, connection, and operation.
- (1) Schedule construction operations in sequence required to obtain the best results where installation of one part of the Work depends on installation of other components, before or after its own installation.
  - (2) Coordinate installation of different components with other contractors to ensure maximum performance and accessibility for required maintenance, service, and repair.
  - (3) Make adequate provisions to accommodate items scheduled for later installation.
- C. Prepare memoranda for distribution to each party involved, outlining special procedures required for coordination. Include such items as required notices, reports, and list of attendees at meetings.
- (1) Prepare similar memoranda for Owner and separate contractors if coordination of their Work is required.
- D. Administrative Procedures: Coordinate scheduling and timing of required administrative procedures with other construction activities and activities of other contractors to avoid conflicts and to ensure orderly progress of the Work. Such administrative activities include, but are not limited to, the following:
- (1) Preparation of Contractor's construction schedule.
  - (2) Preparation of the schedule of values.
  - (3) Installation and removal of temporary facilities and controls.
  - (4) Delivery and processing of submittals.
  - (5) Progress meetings.
  - (6) Pre-installation conferences.
  - (7) Project closeout activities.
  - (8) Startup and adjustment of systems.
- E. Conservation: Coordinate construction activities to ensure that operations are carried out with consideration given to conservation of energy, water, and materials. Coordinate use of temporary utilities to minimize waste.

- (1) Salvage materials and equipment involved in performance of, but not actually incorporated into, the Work. See other Sections for disposition of salvaged materials that are designated as Owner's property.

## **1.06 COORDINATION DRAWINGS:**

- A. Coordination Drawings, General: Prepare coordination drawings according to requirements in individual Sections, and additionally where installation is not completely shown on Shop Drawings, where limited space availability necessitates coordination, or if coordination is required to facilitate integration of products and materials fabricated or installed by more than one entity.
  - (1) Content: Project-specific information, drawn accurately to a scale large enough to indicate and resolve conflicts. Do not base coordination drawings on standard printed data. Include the following information, as applicable:
    - (a) Use applicable Drawings as a basis for preparation of coordination drawings. Prepare sections, elevations, and details as needed to describe relationship of various systems and components.
    - (b) Coordinate the addition of trade-specific information to the coordination drawings by multiple contractors in a sequence that best provides for coordination of the information and resolution of conflicts between installed components before submitting for review.
    - (c) Indicate functional and spatial relationships of components of architectural, structural, civil, mechanical, and electrical systems.
    - (d) Indicate space requirements for routine maintenance and for anticipated replacement of components during the life of the installation.
    - (e) Show location and size of access doors required for access to concealed dampers, valves, and other controls.
    - (f) Indicate required installation sequences.
    - (g) Indicate dimensions shown on the drawings. Specifically note dimensions that appear to be in conflict with submitted equipment and minimum clearance requirements. Provide alternate sketches to Architect indicating proposed resolution of such conflicts. Minor dimension changes and difficult installations will not be considered changes to the Contract.
- B. Coordination Drawing Organization: Organize coordination drawings as follows:

- (1) Floor Plans and Reflected Ceiling Plans: Show architectural and structural elements, and mechanical, plumbing, fire-protection, fire-alarm, and electrical Work. Show locations of visible ceiling-mounted devices relative to acoustical ceiling grid. Supplement plan drawings with section drawings where required to adequately represent the Work.
- (2) Plenum Space: Indicate subframing for support of ceiling and wall systems, mechanical and electrical equipment, and related Work. Locate components within ceiling plenum to accommodate layout of light fixtures indicated on drawings. Indicate areas of conflict between light fixtures and other components.
- (3) Mechanical Rooms: Provide coordination drawings for mechanical rooms showing plans and elevations of mechanical, plumbing, fire-protection, fire-alarm, and electrical equipment.
- (4) Structural Penetrations: Indicate penetrations and openings required for all disciplines.
- (5) Slab Edge and Embedded Items: Indicate slab edge locations and sizes and locations of embedded items for metal fabrications, sleeves, anchor bolts, bearing plates, angles, door floor closers, slab depressions for floor finishes, curbs and housekeeping pads, and similar items.
- (6) Mechanical and Plumbing Work: Show the following:
  - (a) Sizes and bottom elevations of ductwork, piping, and conduit runs, including insulation, bracing, flanges, and support systems.
  - (b) Dimensions of major components, such as dampers, valves, diffusers, access doors, cleanouts and electrical distribution equipment.
  - (c) Fire-rated enclosures around ductwork.
- (7) Electrical Work: Show the following:
  - (a) Runs of vertical and horizontal conduit 1-1/4 inches in diameter and larger.
  - (b) Light fixture, exit light, emergency battery pack, smoke detector, and other fire- alarm locations.
  - (c) Panel board, switch board, switchgear, transformer, busway, generator, and motor control center locations.
  - (d) Location of pull boxes and junction boxes, dimensioned from column center lines.



- (8) Fire-Protection System: Show the following:
    - (a) Locations of standpipes, mains piping, branch lines, pipe drops, and sprinkler heads.
  - (9) Review: Architect will review coordination drawings to confirm that the Work is being coordinated, but not for the details of the coordination, which are Contractor's responsibility. If Architect determines that coordination drawings are not being prepared in sufficient scope or detail, or are otherwise deficient, Architect will so inform Contractor, who shall make changes as directed and resubmit.
  - (10) Coordination Drawing Prints: Prepare coordination drawing prints according to requirements in Section 01 3300 "Submittal Procedures."
- C. Coordination Digital Data Files: Prepare coordination digital data files according to the following requirements:
- (1) File Preparation Format: Same digital data software program, version, and operating system as original Drawings.
  - (2) File Submittal Format: Submit or post coordination drawing files using Portable Data File (PDF) format.
  - (3) Architect will furnish Contractor one set of digital data files of Drawings for use in preparing coordination digital data files.
    - (a) Architect makes no representations as to the accuracy or completeness of digital data files as they relate to Drawings.
    - (b) Digital Data Software Program: Drawings are available in Autodesk 'Revit.'
    - (c) Contractor shall execute a data licensing agreement in the form of AIA Document C106.

**1.07 REQUESTS FOR INFORMATION (RFIs) (see General Conditions § 7.4):**

- A. General: Immediately on discovery of the need for additional information or interpretation of the Contract Documents, Contractor shall prepare and submit an RFI in the form specified.
  - (1) Architect will return RFIs submitted to Architect by other entities controlled by Contractor with no response.
  - (2) Coordinate and submit RFIs in a prompt manner so as to avoid delays in Contractor's work or work of subcontractors.

- B. Content of the RFI: Include a detailed, legible description of item needing information or interpretation and the following:
- (1) Project name.
  - (2) Project number.
  - (3) Date.
  - (4) Name of Contractor.
  - (5) Name of Architect.
  - (6) RFI number, numbered sequentially.
  - (7) RFI subject.
  - (8) Specification Section number and title and related paragraphs, as appropriate.
  - (9) Drawing number and detail references, as appropriate.
  - (10) Field dimensions and conditions, as appropriate.
  - (11) Contractor's suggested resolution. If Contractor's suggested resolution impacts the Contract Time or the Contract Sum, Contractor shall state impact in the RFI. An RFI cannot modify the Contract Sum, Contract Time, or the Contract Documents.
  - (12) Contractor's signature.
  - (13) Attachments: Include sketches, descriptions, measurements, photos, product data, shop drawings, coordination drawings, and other information necessary to fully describe items needing interpretation.
    - (a) Include dimensions, thicknesses, structural grid references, and details of affected materials, assemblies, and attachments on attached sketches.
- C. RFI Forms: Form generated from web-based project information management system with substantially the same content as indicated above, acceptable to Architect.
- (1) Attachments shall be electronic files in Adobe Acrobat PDF format.
- D. Architect's Action: Architect will review each RFI, determine action required, and respond. Allow fourteen (5) calendar days for Architect's response for each RFI.

RFIs received by Architect after 1:00 p.m. will be considered as received the following working day.

- (1) The following Contractor-generated RFIs will be returned without action:
    - (a) Requests for approval of submittals.
    - (b) Requests for approval of substitutions.
    - (c) Requests for approval of Contractor's means and methods.
    - (d) Requests for coordination information already indicated in the Contract Documents.
    - (e) Requests for adjustments in the Contract Time or the Contract Sum.
    - (f) Requests for interpretation of Architect's actions on submittals.
    - (g) Incomplete RFIs or inaccurately prepared RFIs.
  - (2) Architect's action may include a request for additional information, in which case Architect's time for response will date from time of receipt of additional information.
- E. RFI Log: RFI log will be maintained in project's web-based project information management system. Prepare, maintain, and submit a tabular log of RFIs organized by the RFI number. Submit log during all Project Meetings. Use software log that is part of Project Web site.
- F. On receipt of Architect's action, update the RFI log and immediately distribute the RFI response to affected parties. Review response and notify Architect within seven days if Contractor disagrees with response.
- (1) Identification of related Minor Change in the Work, Construction Change Directive, and Proposal Request, as appropriate.
  - (2) Identification of related Field Order, Work Change Directive, and Proposal Request, as appropriate.

#### **1.08 WEB-BASED PROJECT INFORMATION MANAGEMENT SYSTEM:**

- A. Unless otherwise approved, use Owner's Web-Based Project Information Management System for purposes of managing project communication and documentation until Final Completion.

- (1) Software: Procore (<https://www.procore.com/index.php>)
- (2) Functions include, but are not limited to the following:
  - (a) Meeting agendas and minutes.
  - (b) Contract modifications forms and logs.
  - (c) RFI forms and logs.
  - (d) Calendar management.
  - (e) Submittals forms and logs.
  - (f) Payment application forms.
  - (g) Drawing and specification revision hosting, viewing, and updating.
  - (f) Archiving functions.
  - (g) ASI forms and logs.
- (3) The Procore project management software cost is hosted by the Owner, there is no cost to the GC, subcontractors, design consultants, Architect, CM, etc. to use the software. The GC and subcontractor's will be required to enter information and upload documents into the tool to allow for the work flow management throughout the project, which does have an overhead cost element to the entities involved. The bidders should familiarize themselves with all the functionality of the Procore software training or user manuals available to them via the internet prior to bidding. Basic training (conference call) on the functionality of the management tool will be scheduled for the awarded bidder.
- (4) Project Information Management System Training: Owner will schedule and conduct a Project Information Management System Training session before the start of construction.
  - (a) Attendees: All representatives of Owner and Contractor who will be directly interacting with the system shall attend.
  - (b) Additional representative introduced at later dates shall be trained by Owner and Contractor independent of Architect.

#### **1.09 PROJECT MEETINGS (see General Conditions § 3.2.5):**

- A. General: Schedule and conduct meetings and conferences at Project site unless otherwise indicated.

- (1) Attendees: Inform participants and others involved, and individuals whose presence is required, of date and time of each meeting. Notify Owner and Architect of scheduled meeting dates and times.
  - (2) Agenda: Prepare the meeting agenda. Distribute the agenda to all invited attendees.
  - (3) Minutes: Entity responsible for conducting meeting will record significant discussions and agreements achieved. Distribute the meeting minutes to everyone concerned, including Owner and Architect, within three days of the meeting.
  - (4) Project Information Management System includes functions to format the agenda, notify attendees, record meeting minutes, and convert minutes from meeting into next meeting's agenda.
- B. Preconstruction Conference: Owner will schedule and conduct Schedule and conduct a preconstruction conference before starting construction, at a time convenient to Owner and Architect, but no later than 15 days after execution of the Agreement.
- (1) Conduct the conference to review responsibilities and personnel assignments.
  - (2) Attendees: Authorized representatives of Owner, Owner's Commissioning Authority, Architect, and their consultants; Contractor and its superintendent; major subcontractors; suppliers; and other concerned parties shall attend the conference. Participants at the conference shall be familiar with Project and authorized to conclude matters relating to the Work.
  - (3) Agenda: Discuss items of significance that could affect progress, including the following:
    - (a) Tentative construction schedule.
    - (b) Phasing.
    - (c) Critical work sequencing and long-lead items.
    - (d) Designation of key personnel and their duties.
    - (e) Lines of communications.
    - (f) Procedures for processing field decisions and Change Orders.

- (g) Procedures for RFIs.
- (h) Procedures for testing and inspecting.
- (i) Procedures for processing Applications for Payment.
- (j) Distribution of the Contract Documents.
- (k) Submittal procedures.
- (l) Sustainable design requirements.
- (m) Preparation of record documents.
- (n) Use of the premises and existing building.
- (o) Work restrictions.
- (p) Working hours.
- (q) Owner's occupancy requirements.
- (r) Responsibility for temporary facilities and controls.
- (s) Procedures for moisture and mold control.
- (t) Procedures for disruptions and shutdowns.
- (u) Construction waste management and recycling.
- (v) Parking availability.
- (w) Office, work, and storage areas.
- (x) Equipment deliveries and priorities.
- (y) First aid.
- (z) Security.
- (aa) Progress cleaning.
- (bb) Division of the State Architect (DSA) procedures and requirements.

- 1) DSA required documentation
  - 2) DSA deferred-approval submittal review and approval procedures and requirements.
  - 3) DSA Field Inspector procedures and authority.
- (4) Minutes: Entity responsible for conducting meeting will record and distribute meeting minutes.

C. Preinstallation Conferences: Conduct a preinstallation conference at Project site before each construction activity that requires coordination with other construction.

- (1) Attendees: Installer and representatives of manufacturers and fabricators involved in or affected by the installation and its coordination or integration with other materials and installations that have preceded or will follow, shall attend the meeting. Advise Architect and Owner's Commissioning Authority of scheduled meeting dates.
- (2) Agenda: Review progress of other construction activities and preparations for the particular activity under consideration, including requirements for the following:
  - (a) Contract Documents.
  - (b) Options.
  - (c) Related RFIs.
  - (d) Related Change Orders.
  - (e) Purchases.
  - (f) Deliveries.
  - (g) Submittals.
  - (h) Sustainable design requirements.
  - (i) Review of mockups.
  - (j) Possible conflicts.

- (k) Compatibility requirements.
  - (l) Time schedules.
  - (m) Weather limitations.
  - (n) Manufacturer's written instructions.
  - (o) Warranty requirements.
  - (p) Compatibility of materials.
  - (q) Acceptability of substrates.
  - (r) Temporary facilities and controls.
  - (s) Space and access limitations.
  - (t) Regulations of authorities having jurisdiction.
  - (u) Testing and inspecting requirements.
  - (v) Installation procedures.
  - (w) Coordination with other work.
  - (x) Required performance results.
  - (y) Protection of adjacent work.
  - (z) Protection of construction and personnel.
- (3) Record significant conference discussions, agreements, and disagreements, including required corrective measures and actions.
  - (4) Reporting: Distribute minutes of the meeting to each party present and to other parties requiring information.
  - (5) Do not proceed with installation if the conference cannot be successfully concluded. Initiate whatever actions are necessary to resolve impediments to performance of the Work and reconvene the conference at earliest feasible date.



- (6) Minutes: Entity responsible for conducting the meeting will record and distribute the meeting minutes to each party present and to parties requiring information.
  - (a) Schedule Updating: Revise Contractor's construction schedule after each progress meeting where revisions to the schedule have been made or recognized. Issue revised schedule concurrently with the report of each meeting.

**PART 2 – PRODUCTS (Not Used)**

**PART 3 – EXECUTION (Not Used)**

END OF SECTION

## PROJECT MEETINGS

### PART 1 – GENERAL

#### 1.01 RELATED DOCUMENTS AND PROVISIONS:

All Contract Documents should be reviewed for applicable provisions related to the provisions in this document, especially the General Conditions and Agreement.

#### 1.02 PROGRESS MEETINGS:

- A. Contractor shall schedule and hold regular weekly progress meetings after a minimum of one week's prior written notice of the meeting date and time to all Invitees as indicated below.
- B. Location: Contractor's field office, or mutually agreed on other location.
- C. The Contractor shall notify and invite the following entities (“Invitees”):
  - (1) Owner Representative.
  - (2) Contractor.
  - (3) Contractor's Project Manager.
  - (4) Contractor's Superintendent.
  - (5) Subcontractors, as appropriate to the agenda of the meeting.
  - (6) Suppliers, as appropriate to the agenda of the meeting.
  - (7) Construction Manager, if any.
  - (8) Architect
  - (9) Engineer(s), if any and as appropriate to the agenda of the meeting.
  - (10) Others, as appropriate to the agenda of the meeting.
- D. The Owner's, the Architect's, and/or an engineer's Consultants will attend at their discretion, in response to the agenda.
- E. The Owner representative, the Construction Manager, and/or another Owner Agent shall take and distribute meeting notes to attendees and other concerned parties. If exceptions are taken to anything in the meeting notes, those exceptions shall be stated in writing to the Owner within three (3) working days following Owner's distribution of the meeting notes.

- (1) At the Owner's discretion, the Contractor may be requested to take and distribute meeting notes to attendees and other concerned parties.

### **1.03 PRE-INSTALLATION/PERFORMANCE MEETING:**

- A. Contractor shall schedule a meeting prior to the start of each of the following portions of the Work: cutting and patching of plaster and roofing, and other weather-exposed and moisture-resistant products. Contractor shall invite all Invitees to this meeting, and others whose work may affect or be affected by the quality of the cutting and patching work.
- B. Contractor shall review in detail prior to this meeting, the manufacturer's requirements and specifications, applicable portions of the Contract Documents, shop drawings, and other submittals, and other related work. At this meeting, invitees shall review and resolve conflicts, incompatibilities, or inadequacies discovered or anticipated.
- C. Contractor shall review in detail Project conditions, schedule, requirements for performance, application, installation, and quality of completed Work, and protection of adjacent Work and property.
- D. Contractor shall review in detail means of protecting the completed Work during the remainder of the construction period.

### **PART 2 - PRODUCTS (Not Used)**

### **PART 3 - EXECUTION (Not Used)**

END OF SECTION

## **CONSTRUCTION PROGRESS DOCUMENTATION**

### **PART 1 - GENERAL**

#### **1.01 RELATED DOCUMENTS:**

- A. See General Conditions § 3.9 and Article 8.

#### **1.02 SUMMARY:**

- A. Section includes administrative and procedural requirements for documenting the progress of construction during performance of the Work, including the following:
  - (1) Startup construction schedule.
  - (2) Contractor's construction schedule.
  - (3) Construction schedule updating reports.
  - (4) Daily construction reports.
  - (5) Material location reports.
  - (6) Site condition reports.
  - (7) Special reports.
- B. Related requirements:
  - (1) Section 01 33 00 "Submittals" for submitting schedules and reports.
  - (2) Section 01 40 00 "Quality Requirements" for submitting a schedule of tests and inspections.

#### **1.03 DEFINITIONS:**

- A. Activity: A discrete part of a project that can be identified for planning, scheduling, monitoring, and controlling the construction project. Activities included in a construction schedule consume time and resources.
  - (1) Critical Activity: An activity on the critical path that must start and finish on the planned early start and finish times.
  - (2) Predecessor Activity: An activity that precedes another activity in the network.

- (3) Successor Activity: An activity that follows another activity in the network.
- B. Cost Loading: The allocation of the schedule of values for the completion of an activity as scheduled. The sum of costs for all activities must equal the total Contract Sum unless otherwise approved by Owner.
- C. CPM: Critical path method, which is a method of planning and scheduling a construction project where activities are arranged based on activity relationships. Network calculations determine when activities can be performed and the critical path of Project.
- D. Critical Path: The longest connected chain of interdependent activities through the network schedule that establishes the minimum overall Project duration and contains no float.
- E. Event: The starting or ending point of an activity.
- F. Float: The measure of leeway in starting and completing an activity.
  - (1) Float time is not for the exclusive use or benefit of either Owner or Contractor, but is a jointly owned, expiring Project resource available to both parties as needed on a first come first served basis to meet schedule milestones.
  - (2) Free float is the amount of time an activity can be delayed without adversely affecting the early start of the successor activity.
  - (3) Total float is the measure of leeway in starting or completing an activity without adversely affecting the planned Project completion date.
- G. Resource Loading: The allocation of manpower and equipment necessary for the completion of an activity as scheduled.

#### **1.04 INFORMATIONAL SUBMITTALS:**

- A. Format for Submittals: Submit required submittals in the following format:
  - (1) PDF electronic file.
  - (2) Hard copy.
- B. Startup construction schedule.
  - (1) Approval of cost-loaded, startup construction schedule will not constitute approval of schedule of values for cost-loaded activities.

- C. Startup Network Diagram: Of size required to display entire network for entire construction period. Show logic ties for activities.
- D. Contractor's Construction Schedule: Initial schedule, of size required to display entire schedule for entire construction period.

#### **1.05 QUALITY ASSURANCE:**

- A. Scheduling Consultant Qualifications: An experienced specialist in CPM scheduling and reporting, with capability of producing CPM reports and diagrams within 24 hours of Architect's request.
- B. Prescheduling Conference: Conduct conference at Project site to comply with requirements in Section 01 31 00 "Project Management and Coordination." Review methods and procedures related to the preliminary construction schedule and Contractor's construction schedule, including, but not limited to, the following:
  - (1) Review software limitations and content and format for reports.
  - (2) Verify availability of qualified personnel needed to develop and update schedule.
  - (3) Review delivery dates for Owner-furnished products.
  - (4) Review schedule for work of Owner's separate contracts.
  - (5) Review submittal requirements and procedures.
  - (6) Review time required for review of submittals and resubmittals.
  - (7) Review requirements for tests and inspections by independent testing and inspecting agencies.
  - (8) Review time required for Project closeout and Owner startup procedures.
  - (9) Review and finalize list of construction activities to be included in schedule.
  - (10) Review procedures for updating schedule.

#### **1.06 COORDINATION:**

- A. Coordinate Contractor's construction schedule with the schedule of values, submittal schedule, progress reports, payment requests, and other required schedules and reports.

- (1) Secure time commitments for performing critical elements of the Work from entities involved.
- (2) Coordinate each construction activity in the network with other activities and schedule them in proper sequence.

## **PART 2 – PRODUCTS**

### **2.01 CONTRACTOR’S CONSTRUCTION SCHEDULE, GENERAL (see General Conditions § 3.9)**

- A. Time Frame: Extend schedule from date established for the Notice to Proceed to date of final completion.
  - (1) Contract completion date shall not be changed by submission of a schedule that shows an early completion date, unless specifically authorized by Change Order.
- B. Activities: Treat each story or separate area as a separate numbered activity for each main element of the Work. Comply with the following:
  - (1) Activity Duration: Define activities so no activity is longer than 20 days, unless specifically allowed by Architect.
  - (2) Procurement Activities: Include procurement process activities for the following long lead items and major items, requiring a cycle of more than 60 days, as separate activities in schedule. Procurement cycle activities include, but are not limited to, submittals, approvals, purchasing, fabrication, and delivery of:
    - (a) Structural Steel.
    - (b) Aluminum framed entrances and storefronts.
  - (3) Submittal Review Time: Include review and resubmittal times indicated in Section 01 33 00 "Submittals" in schedule. Coordinate submittal review times in Contractor's construction schedule with submittal schedule.
  - (4) Startup and Testing Time: Include no fewer than 15 days for startup and testing.
  - (5) Punch List and Completion: Include not more than 30 days for completion of punch list items and Completion.

- C. Constraints: Include constraints and work restrictions indicated in the Contract Documents and as follows in schedule, and show how the sequence of the Work is affected.
- (1) Phasing: Arrange list of activities on schedule by phase.
  - (2) Work under More Than One Contract: Include a separate activity for each contract.
  - (3) Work by Owner: Include a separate activity for each portion of the Work performed by Owner.
  - (4) Products Ordered in Advance: Include a separate activity for each product. Include delivery date indicated in Section 01 11 00 "Summary of Work." Delivery dates indicated stipulate the earliest possible delivery date.
  - (5) Owner-Furnished Products: Include a separate activity for each product. Include delivery date indicated in Section 01 11 00 "Summary of Work." Delivery dates indicated stipulate the earliest possible delivery date.
  - (6) Work Restrictions: Show the effect of the following items on the schedule:
    - (a) Coordination with existing construction.
    - (b) Limitations of continued occupancies.
    - (c) Uninterruptible services.
    - (d) Partial occupancy before Completion.
    - (e) Use of premises restrictions.
    - (f) Provisions for future construction.
    - (g) Seasonal variations.
    - (h) Environmental control.
  - (7) Work Stages: Indicate important stages of construction for each major portion of the Work, including, but not limited to, the following:
    - (a) Subcontract awards.



- (b) Submittals.
  - (c) Purchases.
  - (d) Mockups.
  - (e) Fabrication.
  - (f) Sample testing.
  - (g) Deliveries.
  - (h) Installation.
  - (i) Tests and inspections.
  - (j) Adjusting.
  - (k) Curing.
  - (l) Building flush-out.
  - (m) Startup and placement into final use and operation.
- (8) Construction Areas: Identify each major area of construction for each major portion of the Work. Indicate where each construction activity within a major area must be sequenced or integrated with other construction activities to provide for the following:
- (a) Structural completion.
  - (b) Temporary enclosure and space conditioning.
  - (c) Permanent space enclosure.
  - (d) Completion of mechanical installation.
  - (e) Completion of electrical installation.
  - (f) Completion.

D. Milestone Deadlines: Include milestone deadlines of the Contract Documents in the schedules, including, but not limited to, the Notice to Proceed, Completion, and the following milestones:

- (1) [LIST MILESTONE DEADLINES FROM AGREEMENT]
- E. Upcoming Work Summary: Prepare summary report indicating activities scheduled to occur or commence prior to submittal of next schedule update. Summarize the following issues:
- (1) Unresolved issues.
  - (2) Unanswered Requests for Information.
  - (3) Rejected or unreturned submittals.
  - (4) Notations on returned submittals.
  - (5) Pending modifications affecting the Work and Contract Time.
- F. Recovery Schedule: When periodic update indicates the Contractor is not prosecuting the Work at a rate sufficient to meet the Work schedule or a contractual milestone, or to Complete the Work within the Contract Time as adjusted by change orders, or if the Contractor's actual progress falls behind the Work schedule or it is apparent to Owner that Contractor will not meet contractual milestones or Complete the Work within the Contract Time as adjusted by change orders, the Owner may require that the Contractor prepare and submit a recovery plan and submit a separate recovery schedule indicating means by which Contractor intends to regain compliance with the schedule. Indicate changes to working hours, working days, crew sizes, and equipment required to achieve compliance, and date by which recovery will be accomplished.
- G. Computer Scheduling Software: Prepare schedules using current version of a program that has been developed specifically to manage construction schedules.

## **2.02 BASELINE CONSTRUCTION SCHEDULE (see General Conditions § 3.9)**

- A. Baseline Construction Schedule: Before the Contractor's commencement of Work or within two (2) weeks of award of the Contract, whichever is earlier, Contractor shall prepare and submit for the Owner's, and any construction manager's, information the baseline construction schedule for the Work, which shall conform to the Contract Documents' requirements.
- B. Preparation: Indicate each significant construction activity separately. Identify first workday of each week with a continuous vertical line. Outline significant construction activities for first 30 days of construction. Include skeleton diagram

for the remainder of the Work and a cash requirement prediction based on indicated activities.

**2.03 CONTRACTOR'S CONSTRUCTION SCHEDULE (CPM SCHEDULE) (see General Conditions § 3.9)**

- A. General: Prepare network diagrams using AON (activity-on-node) format.
- B. Startup Network Diagram: Submit diagram within 15 days of date established for the Notice to Proceed. Outline significant construction activities for the first 90 days of construction. Include skeleton diagram for the remainder of the Work and a cash requirement prediction based on indicated activities.
- C. CPM Schedule: Prepare Contractor's construction schedule using a time-scaled CPM network analysis diagram for the Work.
  - (1) Develop network diagram in sufficient time to submit CPM schedule so it can be accepted for use no later than 60 days after date established for the Notice to Proceed.
    - (a) Failure to include any work item required for performance of this Contract shall not excuse Contractor from completing all work within applicable completion dates, regardless of Owner's approval of the schedule.
  - (2) Conduct educational workshops to train and inform key Project personnel, including subcontractors' personnel, in proper methods of providing data and using CPM schedule information.
  - (3) Establish procedures for monitoring and updating CPM schedule and for reporting progress. Coordinate procedures with progress meeting and payment request dates.
  - (4) Use calendar days as the unit of time for individual activities.
- D. CPM Schedule Preparation: Prepare a list of all activities required to complete the Work. Using the startup network diagram, prepare a skeleton network to identify probable critical paths.
  - (1) Activities: Indicate the estimated time duration, sequence requirements, and relationship of each activity in relation to other activities. Include estimated time frames for the following activities:
    - (a) Preparation and processing of submittals.

- (b) Mobilization and demobilization.
  - (c) Purchase of materials.
  - (d) Delivery.
  - (e) Fabrication.
  - (f) Utility interruptions.
  - (g) Installation.
  - (h) Work by Owner that may affect or be affected by Contractor's activities.
  - (i) Testing and commissioning.
  - (j) Punch list and Completion.
  - (k) Activities occurring following Completion.
- (2) Critical Path Activities: Identify critical path activities, including those for interim completion dates. Scheduled start and completion dates shall be consistent with Contract milestone dates.
  - (3) Processing: Process data to produce output data on a computer-drawn, time-scaled network. Revise data, reorganize activity sequences, and reproduce as often as necessary to produce the CPM schedule within the limitations of the Contract Time.
  - (4) Format: Mark the critical path. Locate the critical path near center of network; locate paths with most float near the edges.
    - (a) Subnetworks on separate sheets are permissible for activities clearly off the critical path.
- E. Contract Modifications: For each proposed contract modification and concurrent with its submission, prepare a time-impact analysis using a network fragment to demonstrate the effect of the proposed change on the overall project schedule.
  - F. Initial Issue of Baseline Schedule: Prepare initial network diagram from a sorted activity list indicating straight "early start-total float." Identify critical activities. Prepare tabulated reports showing the following:

- (1) Contractor or subcontractor and the Work or activity.
  - (2) Description of activity.
  - (3) Main events of activity.
  - (4) Immediate preceding and succeeding activities.
  - (5) Early and late start dates.
  - (6) Early and late finish dates.
  - (7) Activity duration in workdays.
  - (8) Total float or slack time.
  - (9) Average size of workforce.
  - (10) Dollar value of activity (coordinated with the schedule of values).
- G. Schedule Updating: Concurrent with making revisions to schedule, prepare tabulated reports showing the following:
- (1) Identification of activities that have changed.
  - (2) Changes in early and late start dates.
  - (3) Changes in early and late finish dates.
  - (4) Changes in activity durations in workdays.
  - (5) Changes in the critical path.
  - (6) Changes in total float or slack time.
  - (7) Changes in the Contract Time.

## 2.04 REPORTS

- A. Site Condition Reports: Immediately on discovery of a difference between site conditions and the Contract Documents, prepare and submit a detailed report. Submit with a Request for Information. Include a detailed description of the

differing conditions, together with recommendations for changing the Contract Documents.

## **2.05 SPECIAL REPORTS**

- A. General: Submit special reports directly to Owner within one day(s) of an occurrence. Distribute copies of report to parties affected by the occurrence.
- B. Reporting Unusual Events: When an event of an unusual and significant nature occurs at Project site, whether or not related directly to the Work, prepare and submit a special report. List chain of events, persons participating, response by Contractor's personnel, evaluation of results or effects, and similar pertinent information. Advise Owner in advance when these events are known or predictable.

## **PART 3 – EXECUTION**

### **3.01 CONTRACTOR'S CONSTRUCTION SCHEDULE (see General Conditions § 3.9)**

- A. Contractor's Construction Schedule Updating: Contractor shall submit an updated schedule by the first day of every month, and whenever else requested by the Owner. Each schedule update must include an accurate as-built schedule and the current as-planned schedule, both of which shall conform to the Contract Documents' requirements. Contractor shall submit its daily logs for the prior month with the updated schedule. Each update shall comply fully with the requirements in the Contract Documents for baseline and update schedules.
  - (1) Revise schedule immediately after each meeting or other activity where revisions have been recognized or made. Issue updated schedule concurrently with the report of each such meeting.
  - (2) Include a report with updated schedule that indicates every change, including, but not limited to, changes in logic, durations, actual starts and finishes, and activity durations.
  - (3) As the Work progresses, indicate final completion percentage for each activity.
- B. Distribution: Distribute copies of approved schedule to Architect and Owner, separate contractors, testing and inspecting agencies, and other parties identified by Contractor with a need-to-know schedule responsibility.
  - (1) Post copies in Project meeting rooms and temporary field offices.

- (2) When revisions are made, distribute updated schedules to the same parties and post in the same locations. Delete parties from distribution when they have completed their assigned portion of the Work and are no longer involved in performance of construction activities.

END OF SECTION

## SCHEDULING OF WORK

### PART 1 – GENERAL

#### 1.01 RELATED DOCUMENTS AND PROVISIONS:

All Contract Documents should be reviewed for applicable provisions related to the provisions in this document, including without limitation General Conditions § 3.9.

#### 1.02 SECTION INCLUDES:

- A. Scheduling of Work under this Contract shall be performed by Contractor in accordance with requirements of the Contract Documents, including this Section.
  - (1) Development of schedule, cost and resource loading of the schedule, payments, and project status reporting requirements of the Contract shall employ computerized Critical Path Method (“CPM”) scheduling (“CPM Schedule”).
  - (2) CPM Schedule shall be cost loaded based on payment as approved by Owner.
  - (3) Submit schedules and reports as specified in the General Conditions.
- B. Upon award of Contract, Contractor shall immediately commence development of CPM schedules to ensure compliance with CPM schedule submittal requirements.

#### 1.03 CONSTRUCTION SCHEDULE; HOURS OF WORK:

- A. Within five (5) days of being awarded the Contract and before request for first progress payment, the Contractor shall prepare and submit to the Owner a construction progress schedule conforming to the Agreement.
- B. The schedule shall be continuously updated, and an updated schedule shall be submitted with each application for progress payment. Each revised schedule shall indicate the work actually accomplished during the previous period and the schedule for completion of the remaining work.
- C. The hours of work shall be as follows.

#### *HOURS OF CONSTRUCTION OPERATIONS*

**[FILL IN OR MODIFY AS APPROPRIATE FOR EACH PROJECT]**

<b>Weekdays:</b>	<b>7:00 a.m. to 7:00 p.m.</b>
<b>Weekends:</b>	<b>7:00 a.m. to 7:00 p.m. (Approved in Advance)</b>
<b>After hours</b>	<b>7:00 p.m. to 7:00 a.m. (Approved in Advance)</b>



## 1.04 QUALIFICATIONS

- A. Contractor shall employ experienced scheduling personnel qualified to use the latest version of E-Builder. Experience level required is set forth below. Contractor may employ such personnel directly or may employ a consultant for this purpose.
  - (1) The written statement shall identify the individual who will perform CPM scheduling.
  - (2) Capability and experience shall be verified by description of construction projects on which individual has successfully applied computerized CPM.
  - (3) Required level of experience shall include at least two (2) projects of similar nature and scope with value not less than three fourths ( $\frac{3}{4}$ ) of the Contract Price of this Project. The written statement shall provide contact persons for referenced projects with current telephone and address information.
- B. Owner reserves the right to approve or reject Contractor's scheduler or consultant at any time. Owner reserves the right to refuse replacing of Contractor's scheduler or consultant, if Owner believes replacement will negatively affect the scheduling of Work under this Contract.

## 1.05 GENERAL

- A. Schedule shall be based on and incorporate milestone and completion dates specified in Contract Documents.
- B. Overall time of completion and time of completion for each milestone shown on Progress schedule shall adhere to times in the Contract, unless an earlier (advanced) deadline for Completion is requested by Contractor and agreed to by Owner, and formalized by a Change Order.
  - (1) Owner is not required to accept an early completion schedule, i.e., one that shows an earlier completion date than the Contract Time.
  - (2) Contractor shall not be entitled to extra compensation in event agreement is reached on an earlier completion schedule and Contractor completes its Work, for whatever reason, beyond completion date shown in its early completion schedule but within the Contract Time.
  - (3) A schedule showing the work completed in less than the Contract Time, and that has been accepted by Owner, shall be considered to have Project float. Project float is a resource available to both Owner and the Contractor.

- C. Ownership Project float: Neither the Owner nor Contractor owns Project float. The Project owns the Project float. As such, liability for delay of Completion rests with the party whose actions, last in time, actually cause delay to Completion.
  - (1) For example, if Party A uses some, but not all of the Project float and Party B later uses remainder of the Project float as well as additional time beyond the Project float, Party B shall be liable for the time that represents a delay to Completion.
  - (2) Party A would not be responsible for the time since it did not consume the entire Project float and additional Project float remained; therefore, Completion was unaffected by Party A.
- D. Progress schedule shall be the basis for evaluating job progress, payment requests, and time extension requests. Responsibility for developing Contract CPM Schedule and monitoring actual progress as compared to progress schedule rests with Contractor.
- E. Failure of progress schedule to include any element of the Work, or any inaccuracy in progress schedule, will not relieve Contractor from responsibility for accomplishing the Work in accordance with the Contract. Owner's acceptance of schedule shall be for its use in monitoring and evaluating job progress, payment requests, and time extension requests and shall not, in any manner, impose a duty of care upon Owner, or act to relieve Contractor of its responsibility for means and methods of construction.
- F. Software: Use a program specified by the Agreement. Such software shall be compatible with Windows operating system. Contractor shall transmit contract file to Owner on compact disk at times requested by Owner.
- G. Transmit each item under the form approved by Owner.
  - (1) Identify Project with Owner Contract number and name of Contractor.
  - (2) Provide space for Contractor's approval stamp and Owner's review stamps.
  - (3) Submittals received from sources other than Contractor will be returned to the Contractor without Owner's review.

## **1.06 [Not Used]**

## **1.07 BASELINE CPM SCHEDULE**

- A. Submit a detailed proposed baseline CPM schedule presenting an orderly and realistic plan for completion of the Work in conformance with requirements as specified herein.

- B. Progress schedule shall include or comply with following requirements:
- (1) Time scaled, cost and resource (labor and major equipment) loaded CPM schedule.
  - (2) No activity on schedule shall have duration longer than fifteen (15) calendar days, with exception of submittal, approval, fabrication and procurement activities, unless otherwise approved by Owner.
    - (a) Activity durations shall be total number of actual calendar days required to perform that activity.
  - (3) The start and completion dates of all items of Work, their major components, and milestone completion dates, if any.
  - (4) Owner furnished materials and equipment, if any, identified as separate activities.
  - (5) Activities for maintaining Project Record Documents.
  - (6) Dependencies (or relationships) between activities.
  - (7) Processing/approval of submittals and shop drawings for all material and equipment required per the Contract. Activities that are dependent on submittal acceptance or material delivery shall not be scheduled to start earlier than expected acceptance or delivery dates.
    - (a) Include time for submittals, re-submittals and reviews by Owner. Coordinate with accepted schedule for submission of shop drawings, samples, and other submittals.
    - (b) Contractor shall be responsible for all impacts resulting from re-submittal of shop drawings and submittals.
  - (8) Procurement of major equipment, through receipt and inspection at jobsite, identified as separate activity.
    - (a) Include time for fabrication and delivery of manufactured products for the Work.
    - (b) Show dependencies between procurement and construction.
  - (9) Activity description; what Work is to be accomplished and where.
  - (10) The total cost of performing each activity shall be total of labor, material, and equipment, excluding overhead and profit of Contractor. Overhead and profit of the Contractor shall be shown as a separate activity in the schedule. Sum of cost for all activities shall equal total Contract value.

- (11) Resources required (labor and major equipment) to perform each activity.
  - (12) Responsibility code for each activity corresponding to Contractor or Subcontractor responsible for performing the Work.
  - (13) Identify the activities which constitute the controlling operations or critical path. No more than twenty-five (25%) of the activities shall be critical or near critical. Near critical is defined as float in the range of one (1) to (5) days.
  - (14) Thirty (30) calendar days for developing punch list(s), completion of punch-list items, and final clean up for the Work or any designated portion thereof. No other activities shall be scheduled during this period.
  - (15) Interface with the work of other contractors, Owner, and agencies such as, but not limited to, utility companies.
  - (16) Show detailed Subcontractor Work activities. In addition, furnish copies of Subcontractor schedules upon which CPM was built.
    - (a) Also furnish for each Subcontractor, as determined by Owner, submitted on Subcontractor letterhead, a statement certifying that Subcontractor concurs with Contractor's CPM schedule and that Subcontractor's related schedules have been incorporated, including activity duration, cost and resource loading.
    - (b) Subcontractor schedules shall be independently derived and not a copy of Contractor's schedule.
    - (c) In addition to Contractor's schedule and resource loading, obtain from electrical, mechanical, and plumbing Subcontractors, and other Subcontractors as required by Owner, productivity calculations common to their trades, such as units per person day, feet of pipe per day per person, feet of wiring per day per person, and similar information.
    - (d) Furnish schedule for Contractor/Subcontractor CPM schedule meetings which shall be held prior to submission of baseline CPM schedule to Owner. Owner shall be permitted to attend scheduled meetings as an observer.
  - (17) Activity durations shall be in calendar days.
  - (18) Submit with the schedule a list of anticipated non-work days, such as weekends and holidays.
- C. Baseline CPM Schedule Review Meeting: Contractor shall, within five (5) days from the Notice to Proceed date, meet with Owner to review the baseline CPM schedule submittal.

- (1) Contractor shall have its Project Manager, Project Superintendent, Project Scheduler, and key Subcontractor representatives, as required by Owner, in attendance. The meeting will take place over a continuous one (1) day period.
- (2) Owner's review will be limited to submittal's conformance to Contract requirements including, but not limited to, coordination requirements. However, review may also include:
  - (a) Clarifications of Contract Requirements.
  - (b) Directions to include activities and information missing from submittal.
  - (c) Requests to Contractor to clarify its schedule.
- (3) Within three (3) days of the Schedule Review Meeting, Contractor shall respond in writing to all questions and comments expressed by Owner at the Meeting.

#### **1.08 ADJUSTMENTS TO BASELINE CPM SCHEDULE**

- A. Adjustments to Baseline CPM Schedule: Contractor shall have adjusted the baseline CPM schedule submittal to address all review comments from original CPM Schedule review meeting and resubmit network diagrams and reports for Owner's review.
  - (1) Owner, within three (3) days from date that Contractor submitted the revised schedule, will either:
    - (a) Accept schedule and cost and resource loaded activities as submitted, or
    - (b) Advise Contractor in writing to review any part or parts of schedule which either do not meet Contract requirements or are unsatisfactory for Owner to monitor Project's progress, resources, and status or evaluate monthly payment request by Contractor.
  - (2) Owner may accept schedule with conditions that the first monthly CPM Schedule update be revised to correct deficiencies identified.
  - (3) When schedule is accepted, it shall be considered the "Baseline CPM Schedule" which will then be immediately updated to reflect the current status of the work.
  - (4) Owner reserves right to require Contractor to adjust, add to, or clarify any portion of schedule which may later be discovered to be insufficient for monitoring of Work or approval of partial payment requests. No additional compensation will be provided for such adjustments, additions, or clarifications.

- B. Acceptance of Contractor's schedule by Owner will be based solely upon schedule's compliance with Contract requirements.
- (1) By way of Contractor assigning activity durations and proposing sequence of Work, Contractor agrees to utilize sufficient and necessary management and other resources to perform work in accordance with the schedule.
  - (2) Upon submittal of schedule update, updated schedule shall be considered "current" CPM Schedule.
  - (3) Submission of Contractor's schedule to Owner shall not relieve Contractor of total responsibility for scheduling, sequencing, and pursuing Work to comply with requirements of Contract Documents, including adverse effects such as delays resulting from ill-timed Work.
- C. Submittal of baseline CPM schedule, and subsequent schedule updates, shall be understood to be Contractor's representation that the schedule meets requirements of Contract Documents and that Work shall be executed in sequence indicated on the schedule.
- D. Contractor shall distribute baseline CPM schedule to Subcontractors for review and written acceptance, which shall be noted on Subcontractors' letterheads to Contractor and transmitted to Owner for the record.

#### **1.09 MONTHLY CPM SCHEDULE UPDATE SUBMITTALS**

- A. Following acceptance of Contractor's baseline CPM schedule, Contractor shall monitor progress of Work and adjust schedule each month to reflect actual progress and any anticipated changes to planned activities.
- (1) Each schedule update submitted shall be complete, including all information requested for the baseline CPM schedule submittal.
  - (2) Each update shall continue to show all Work activities including those already completed. These completed activities shall accurately reflect "as built" information by indicating when activities were actually started and completed.
- B. A meeting will be held on approximately the twenty fifth (25th) of each month to review the schedule update submittal and progress payment application.
- (1) At this meeting, at a minimum, the following items will be reviewed: Percent (%) complete of each activity; Time Impact Evaluations for Change Orders and Time Extension Request; actual and anticipated activity sequence changes; actual and anticipated duration changes; and actual and anticipated Contractor delays.
  - (2) These meetings are considered a critical component of overall monthly schedule update submittal and Contractor shall have appropriate personnel attend. At a

minimum, these meetings shall be attended by Contractor's General Superintendent and Scheduler.

- (3) Contractor shall plan on the meeting taking no less than four (4) hours.
- C. Within seven (7) calendar days after monthly schedule update meeting, Contractor shall submit the updated CPM schedule update.
- D. Within seven (7) calendar days of receipt of above noted revised submittals, Owner will either accept or reject monthly schedule update submittal.
  - (1) If accepted, percent (%) complete shown in monthly update will be basis for application for payment by the Contractor. The schedule update shall be submitted as part of the Contractor's application for payment.
  - (2) If rejected, update shall be corrected and resubmitted by Contractor before the application for payment is submitted.
- E. Neither updating, changing or revising of any report, curve, schedule, or narrative submitted to Owner by Contractor under this Contract, nor Owner's review or acceptance of any such report, curve, schedule or narrative shall have the effect of amending or modifying in any way the Completion Date or milestone dates or of modifying or limiting in any way Contractor's obligations under this Contract.

## **1.10 SCHEDULE REVISIONS**

- A. Updating the schedule to reflect actual progress shall not be considered revisions to the schedule. Since scheduling is a dynamic process, revisions to activity durations and sequences are expected on a monthly basis.
- B. To reflect revisions to the schedule, the Contractor shall provide Owner with a written narrative with a full description and reasons for each Work activity revised. For revisions affecting the sequence of work, the Contractor shall provide a schedule diagram which compares the original sequence to the revised sequence of work. The Contractor shall provide the written narrative and schedule diagram for revisions two (2) working days in advance of the monthly schedule update meeting.
- C. Schedule revisions shall not be incorporated into any schedule update until the revisions have been reviewed by Owner. Owner may request further information and justification for schedule revisions and Contractor shall, within three (3) days, provide Owner with a complete written narrative response to Owner's request.
- D. If the Contractor's revision is still not accepted by Owner, and the Contractor disagrees with Owner's position, the Contractor has seven (7) calendar days from receipt of Owner's letter rejecting the revision to provide a written narrative providing full justification and explanation for the revision. The Contractor's failure to respond in writing within seven (7) calendar days of Owner's written

rejection of a schedule revision shall be contractually interpreted as acceptance of Owner's position, and the Contractor waives its rights to subsequently dispute or file a claim regarding Owner's position.

- E. At Owner's discretion, the Contractor can be required to provide Subcontractor certifications of performance regarding proposed schedule revisions affecting said Subcontractors.

#### **1.11 RECOVERY SCHEDULE**

- A. If the schedule update shows a completion date seven (7) calendar days beyond the Contract Completion deadline, or individual milestone deadline, the Contractor shall submit to Owner the proposed revisions to recover the lost time within three (3) calendar days. As part of this submittal, the Contractor shall provide a written narrative for each revision made to recapture the lost time. If the revisions include sequence changes, the Contractor shall provide a schedule diagram comparing the original sequence to the revised sequence of work. See General Conditions §3.9.
- B. The revisions shall not be incorporated into any schedule update until the revisions have been reviewed by Owner.
- C. If the Contractor's revisions are not accepted by Owner, Owner and the Contractor shall follow the procedures in paragraph 1.09.C, 1.09.D and 1.09.E above.
- D. At Owner's discretion, the Contractor can be required to provide Subcontractor certifications for revisions affecting said Subcontractors.

#### **1.12 TIME IMPACTS EVALUATION ("TIE") FOR CHANGE ORDERS, AND OTHER DELAYS**

- A. When Contractor is directed to proceed with Work and it feels that it is entitled to a time extension, it shall comply with time extension requirements in the Contract Documents, including submittal of a TIE with a COR that includes both a written narrative and a schedule diagram depicting how the changed Work affects other schedule activities. The schedule diagram shall show how the Contractor proposes to incorporate the changed Work in the schedule and how it impacts the current schedule-update critical path. The Contractor is also responsible for requesting time extensions based on the TIE's impact on the critical path. The diagram must be tied to the main sequence of schedule activities to enable Owner to evaluate the impact of changed Work to the scheduled critical path.
- B. Contractor shall be required to comply with the requirements of Paragraph 1.09.A and General Conditions Article 4 and 8 for all types of delays such as, but not limited to, Contractor/Subcontractor delays, adverse weather delays, strikes, procurement delays, fabrication delays, etc.



- C. Contractor shall be responsible for all costs associated with the preparation of time extension requests, and the process of incorporating them into the current schedule update. The Contractor shall provide Owner with one (1) hard copy, one (1) electronic and upload into e-Builder, of each TIE.
- D. Once agreement has been reached on a time extension request, the Contract Time will be adjusted accordingly by change order. If agreement is not reached on a time extension request, the Contract Time may be extended in an amount Owner allows, and the Contractor may submit a claim for additional time.

### **1.13 TIME EXTENSIONS**

- A. The Contractor is responsible for requesting time extensions for time impacts that, in the opinion of the Contractor, impact the critical path of the current schedule update. Notice of time impacts and requests for time extension shall be given in accord with the General Conditions.
- B. Where an event for which Owner is responsible impacts the projected Completion, the Contractor shall provide a written mitigation plan, including a schedule diagram, which explains how (e.g., increase crew size, overtime, etc.) the impact can be mitigated. The Contractor shall also include a detailed cost breakdown of the labor, equipment, and material the Contractor would expend to mitigate Owner-caused time impact. The Contractor shall submit its mitigation plan to Owner within five (5) calendar days from the date of discovery of the impact. The Contractor is responsible for the cost to prepare the mitigation plan.
- C. Failure to request time, provide TIE, or provide the mitigation plan as required by the Contract Documents will result in Contractor waiving its right to a time extension and cost to mitigate the delay.
- D. No time will be granted under this Contract for cumulative effect of changes.
- E. Owner will not be obligated to consider any time extension request unless the Contractor complies with the requirements of the Contract Documents.
- F. Failure of the Contractor to perform in accordance with the current schedule update shall not be excused by submittal of time extension requests.
- G. If the Contractor does not submit a TIE within the contractually-required time for any issue, it is mutually agreed that the Contractor does not require a time extension for said issue.

### **1.14 SCHEDULE REPORTS**

- A. Submit one (1) hard copy and one (1) electronic copy of the following reports with the baseline CPM schedule, and each monthly update.
- B. Required Reports:

- (1) Two activity listing reports: one sorted by activity number and one by total Project float. These reports shall also include each activity's early/late and actual start and finish dates, original and remaining duration, Project float, responsibility code, and the logic relationship of activities.
- (2) Cost report sorted by activity number including each activity's associated cost, percentage of Work accomplished, earned value- to date, previous payments, and amount earned for current update period.
- (3) Schedule plots presenting time-scaled network diagram showing activities and their relationships with the controlling operations or critical path clearly highlighted.
- (4) Cash flow report calculated by early start, late start, and indicating actual progress. Provide an exhibit depicting this information in graphic form.
- (5) Planned versus actual resource (i.e., labor) histogram calculated by early start and late start.

C. Other Reports

In addition to above reports, Owner may request, from month to month, any two of the following reports. Submit one (1) hard copy and one (1) electronic copy of all reports.

- (1) Activities by early start.
  - (2) Activities by late start.
  - (3) Activities grouped by Subcontractors or selected trades.
  - (4) Activities with scheduled early start dates in a given time frame, such as fifteen (15) or thirty (30) day outlook.
- D. Furnish Owner with one (1) hard copy and one (1) electronic copy of all report files containing all schedule files for each report generated.

## 1.15 PROJECT STATUS REPORTING

- A. In addition to submittal requirements for CPM scheduling identified in this Section, Contractor shall provide a monthly project status report (i.e., written narrative report) to be submitted in conjunction with each CPM schedule as specified herein. Status reporting shall be in form specified below.
- B. Contractor shall prepare monthly written narrative reports of status of Project for submission to Owner. Written status reports shall include:

- (1) Status of major Project components (percent (%) complete, amount of time ahead or behind schedule) and an explanation of how Project will be brought back on schedule if delays have occurred.
- (2) Progress made on critical activities indicated on CPM Schedule.
- (3) Explanations for any lack of work on critical path activities planned to be performed during last month.
- (4) Explanations for any schedule changes, including changes to logic or to activity durations.
- (5) List of critical activities scheduled to be performed next month.
- (6) Status of major material and equipment procurement.
- (7) Any delays encountered during reporting period.
- (8) Contractor shall provide printed report indicating actual versus planned resource loading for each trade and each activity. This report shall be provided on weekly and monthly basis.
  - (a) Actual resource shall be accumulated in field by Contractor, and shall be as noted on Contractor's daily reports. These reports will be basis for information provided in computer-generated monthly and weekly printed reports.
  - (b) Contractor shall explain all variances and mitigation measures.
- (9) Contractor may include any other information pertinent to status of Project. Contractor shall include additional status information requested by Owner at no additional cost.
- (10) Status reports, and the information contained therein, shall not be construed as claims, notice of claims, notice of delay, or requests for changes or compensation.

## **1.16 WEEKLY SCHEDULE REPORT**

At the weekly progress meeting, the Contractor shall provide and present a time-scaled three (3) week look-ahead schedule that is based and correlated by activity number to the current schedule (i.e., baseline CPM, or schedule update).

## **1.17 DAILY CONSTRUCTION REPORTS**

On a daily basis, Contractor shall submit a daily activity report to Owner for each workday, including weekends and holidays when worked. Contractor shall develop the daily construction reports on a computer-generated database capable of sorting daily

Work, manpower, and manhours by Contractor, Subcontractor, area, sub-area, and change order Work. Upon request of Owner, furnish computer disk of this data base. Obtain Owner's written approval of daily construction report data base format prior to implementation. Include in report:

- A. Project name and Project number.
- B. Contractor's name and address.
- C. Weather, temperature, and any unusual site conditions.
- D. Brief description and location of the day's scheduled activities and any special problems and accidents, including Work of Subcontractors. Descriptions shall be referenced to CPM scheduled activities.
- E. Worker quantities for its own Work force and for Subcontractors of any tier.
- F. Equipment, other than hand tools, utilized by Contractor and Subcontractors.

#### **1.18 PERIODIC VERIFIED REPORTS**

Contractor shall complete and verify construction reports on a form prescribed by the Division of the State Architect and file reports on the first day of February, May, August, and November during the preceding quarter year; at the completion of the Contract; at the completion of the Work; at the suspension of Work for a period of more than one (1) month; whenever the services of Contractor or any of Contractor's Subcontractors are terminated for any reason; and at any time a special verified report is required by the Division of the State Architect. Refer to section 4-336 and section 4-343 of Part 1, Title 24 of the California Code of Regulations.

**PART 2 – PRODUCTS (Not Used)**

**PART 3 - EXECUTION (Not Used)**

END OF SECTION

## SUBMITTALS

### PART 1 - GENERAL

#### 1.01 RELATED DOCUMENTS AND PROVISIONS:

All Contract Documents should be reviewed for applicable provisions related to the provisions in this document, including without limitation General Conditions §3.11.

#### 1.02 SECTION INCLUDES:

A. Definitions:

- (1) Shop Drawings and Product Data are as indicated in the General Conditions and include, but are not limited to, fabrication, erection, layout and setting drawings, formwork and falsework drawings, manufacturers' standard drawings, descriptive literature, catalogues, brochures, performance and test data, wiring and control diagrams. In addition, there are other drawings and descriptive data pertaining to materials, equipment, piping, duct and conduit systems, and methods of construction as may be required to show that the materials, equipment or systems and all positions conform to the requirement of the Contract Documents, including, without limitation, the Drawings.
- (2) "Manufactured" applies to standard units usually mass-produced; "fabricated" means specifically assembled or made out of selected materials to meet design requirements. Shop Drawings shall establish the actual detail of manufactured or fabricated items, indicated proper relation to adjoining work and amplify design details of mechanical and electrical equipment in proper relation to physical spaces in the structure.
- (3) Manufacturer's Instructions: Where any item of Work is required by the Contract Documents to be furnished, installed, or performed, at a minimum, in accordance with a specified product manufacturer's instructions, the Contractor shall procure and distribute copies of these to the Owner, the Architect, and all other concerned parties and shall furnish, install, or perform the work, at a minimum, in accordance with those instructions.

B. Samples, Shop Drawings, Product Data, and other items as specified, in accordance with the following requirements:

- (1) The submittal process shall be as set forth in the General Conditions and this document, unless otherwise directed by the Owner.
- (2) Contractor shall submit all Shop Drawings, Product Data, and Samples to the Owner, the Architect, the Project Inspector, and the Construction Manager.

- (3) Contractor shall comply with all time frames herein and in the General Conditions and, in any case, shall submit required information in sufficient time to permit proper consideration and action before ordering any materials or items represented by such Shop Drawings, Product Data, and/or Samples.
- (4) Contractor shall comply with all time frames herein and in the General Conditions and, in any case, shall allow sufficient time so that no delay occurs due to required lead time in ordering or delivery of any item to the Site. Contractor shall be responsible for any delay in progress of Work due to its failure to observe these requirements.
- (5) Time for completion of Work shall not be extended on account of Contractor's failure to promptly submit Shop Drawings, Product Data, and/or Samples.
- (6) Reference numbers on Shop Drawings shall have Architectural and/or Engineering Contract Drawings reference numbers for details, sections, and "cuts" shown on Shop Drawings. These reference numbers shall be in addition to any numbering system that Contractor chooses to use or has adopted as standard.
- (7) When the magnitude or complexity of submittal material prevents a complete review within the stated time frame, Contractor shall make this submittal in increments to avoid extended delays.
- (8) Contractor shall certify on submittals for review that submittals conform to Contract requirements. In event of any variance, Contractor shall specifically state in transmittal and on Shop Drawings, portions vary and require approval of a substitute. Also certify that Contractor-furnished equipment can be installed in allocated space.
- (9) Unless specified otherwise, sampling, preparation of samples, and tests shall be in accordance with the latest standard of the American Society for Testing and Materials.
- (10) Upon demand by Architect or Owner, Contractor shall submit samples of materials and/or articles for tests or examinations and consideration before Contractor incorporates same in Work. Contractor shall be solely responsible for delays due to sample(s) not being submitted in time to allow for tests. Acceptance or rejection will be expressed in writing. Work shall be equal to approved samples in every respect. Samples that are of value after testing will remain the property of Contractor.

C. Submittal Schedule:

- (1) Contractor shall prepare its proposed submittal schedule that is coordinated with its proposed construction schedule and submit both to the Owner within five (5) days after the date of the Notice to Proceed. Contractor's proposed schedules

shall become the Project Construction Schedule and the Project Submittal Schedule after each is approved by the Owner.

- (2) Contractor is responsible for all lost time should the initial submittal be rejected, marked "revised and resubmit," etc.
- (3) All Submittals shall be forwarded to the Owner by the date indicated on the approved Submittal Schedule, unless an earlier date is necessary to maintain the Construction Schedule, in which case those Submittals shall be forwarded to the Owner so as not to delay the Construction Schedule.

### **1.03 SHOP DRAWINGS:**

- A. Before commencing installation of any Work, the Contractor shall submit and receive approval of all drawings, descriptive data, and material list(s) as required to accomplish Work.
- B. Review of Shop Drawings is regarded as a service to assist Contractor and in all cases original Contract Documents shall take precedence as outlined under General Conditions.
- C. No claim for extra time or payment shall be based on work shown on Shop Drawings unless the claim is (1) noted on Contractor's transmittal letter accompanying Shop Drawings and (2) Contractor has complied with all applicable provisions of the General Conditions, including, without limitation, provisions regarding changes and payment, and all required written approvals.
- D. Owner and / or Architect shall not review Shop Drawings for quantities of materials or number of items supplied.
- E. Owner's and/or Architect's review of Shop Drawing will be general. Owner and/or Architect review does not relieve Contractor of responsibility for accuracy, proper fitting, construction of Work, furnishing of materials, or Work required by Contract Documents and not indicated on Shop Drawings. Shop Drawing reviewed by Owner and/or Architect is not to be construed as approving departures from Contract Documents.
- F. Review of Shop Drawings and Schedules does not relieve Contractor from responsibility for any aspect of those Drawings or Schedules that is a violation of local, County, State, or Federal laws, rules, ordinances, or rules and regulations of commissions, boards, or other authorities or utilities having jurisdiction.
- G. Before submitting Shop Drawings for review, Contractor shall check Shop Drawings of its subcontractors for accuracy, and confirm that all Work contiguous with and having bearing on other work shown on Shop Drawings is accurately drawn and in conformance with Contract Documents.
- H. Submitted drawings and details must bear stamp of approval of Contractor:

- (1) Stamp and signature shall clearly certify that Contractor has checked Shop Drawings for compliance with Drawings.
  - (2) If Contractor submits a Shop Drawing without an executed stamp of approval, or whenever it is evident (despite stamp) that Drawings have not been checked the Owner and/or Architect will not consider them and will return them to the Contractor for revision and resubmission. In that event, it will be deemed that Contractor has not complied with this provision and Contractor shall bear risk of all delays to same extent as if it had not submitted any Shop Drawings or details.
- I. Submission of Shop Drawings (in either original submission or when resubmitted with correction) constitutes evidence that Contractor has checked all information thereon and that it accepts and is willing to perform Work as shown.
  - J. Contractor shall pay for cost of any changes in construction due to improper checking and coordination. Contractor shall be responsible for all additional costs, including coordination. Contractor shall be responsible for costs incurred by itself, the Owner, the Architect, the Project Inspector, the Construction Manager, any other Subcontractor or contractor, etc., due to improperly checked and/or coordination of submittals.
  - K. Shop Drawings must clearly delineate the following information:
    - (1) Project name and address.
    - (2) Specification number and description.
    - (3) Architect's name and project number.
    - (4) Shop Drawing title, number, date, and scale.
    - (5) Names of Contractor, Subcontractor(s) and fabricator.
    - (6) Working and erection dimensions.
    - (7) Arrangements and sectional views.
    - (8) Necessary details, including complete information for making connections with other Work.
    - (9) Kinds of materials and finishes.
    - (10) Descriptive names of materials and equipment, classified item numbers, and locations at which materials or equipment are to be installed in the Work. Contractor shall use same reference identification(s) as shown on Contract Drawings.



- L. Contractor shall prepare composite drawings and installation layouts when required to solve tight field conditions.
  - (1) Shop Drawings shall consist of dimensioned plans and elevations and must give complete information, particularly as to size and location of sleeves, inserts, attachments, openings, conduits, ducts, boxes, structural interferences, etc.
  - (2) Contractor shall coordinate these composite Shop Drawings and installation layouts in the field between itself and its Subcontractor(s) for proper relationship to the Work, the work of other trades, and the field conditions. The Contractor shall check and approve all submittal(s) before submitting them for final review.

**1.04 PRODUCT DATA OR NON REPRODUCIBLE SUBMITTALS:**

- A. Contractor shall submit manufacturer's printed literature in original form. Any fading type of reproduction will not be accepted. Contractor must submit a minimum of two (2) hard copies each, to the Owner and / or Architect. Owner and / or Architect shall return one (1) to the Contractor, who shall reproduce whatever additional copies it requires for distribution.
- B. Contractor shall submit one (1) hard copy, one (1) PDF electronic of a complete list of all major items of mechanical, plumbing, and electrical equipment and materials in accordance with the approved Submittal Schedule, except as required earlier to comply with the approved Construction Schedule. Other items specified are to be submitted prior to commencing Work. Contractor shall submit items of like kind at one time in a neat and orderly manner. Partial lists will not be acceptable.
- C. Submittals shall include manufacturer's specifications, physical dimensions, and ratings of all equipment. Contractor shall furnish performance curves for all pumps and fans. Where printed literature describes items in addition to that item being submitted, submitted item shall be clearly marked on sheet and superfluous information shall be crossed out. If highlighting is used, Contractor shall mark all copies.
- D. Equipment submittals shall be complete and include space requirements, weight, electrical and mechanical requirements, performance data, and supplemental information that may be requested.

**1.05 SAMPLES:**

- A. Contractor shall submit for approval Samples as required and within the time frame in the Contract Documents. Materials such as concrete, mortar, etc., which require on-site testing will be obtained from Project Site.
- B. Contractor shall submit four (4) samples except where greater or lesser number is specifically required by Contract Documents including, without limitation, the Specifications.

- (1) Samples must be of sufficient size and quality to clearly illustrate functional characteristics, with integrally related parts and attachment devices.
  - (2) Samples must show full range of texture, color, and pattern.
- C. Contractor shall make all Submittals, unless it has authorized Subcontractor(s) to submit and Contractor has notified the Owner in writing to this effect.
  - D. Samples are to be shipped prepaid or hand-delivered to the Owner.
  - E. Contractor shall mark samples to show name of Project, name of Contractor submitting, Contract number and segment of Work where representative Sample will be used, all applicable Specifications Sections and documents, Contract Drawing Number and detail, and ASTM or FS reference, if applicable.
  - F. Contractor shall not deliver any material to Site prior to receipt of Owner's and/or Architect's completed written review and approval. Contractor shall furnish materials equal in every respect to approved Samples and execute Work in conformance therewith.
  - G. Owner's and/or Architect's review, acceptance, and/or approval of Sample(s) will not preclude rejections of any material upon discovery of defects in same prior to final acceptance of completed Work.
  - H. After a material has been approved, no change in brand or make will be permitted.
  - I. Contractor shall prepare its Submittal Schedule and submit Samples of materials requiring laboratory tests to specified laboratory for testing not less than ten (10) days before such materials are required to be used in Work.
  - J. Samples which are rejected must be resubmitted promptly after notification of rejection and be marked "Resubmitted Sample" in addition to other information required.
  - K. Field Samples and Mock-Ups are to be removed by Contractor at Owner's direction:
    - (1) Size: As Specified.
    - (2) Furnish catalog numbers and similar data, as requested.

#### **1.06 REVIEW AND RESUBMISSION REQUIREMENTS:**

- A. The Owner will arrange for review of Sample(s), Shop Drawing(s), Product Data, and other submittal(s) by appropriate reviewer and return to Contractor as provided below within five (5) days after receipt or within five (5) days after receipt of all related information necessary for such review, whichever is later.

- B. One (1) copy of product or materials data will be returned to Contractor with the review status.
- C. Samples to be incorporated into the Work will be returned to Contractor, together with a written notice designating the Sample with the appropriate review status and indicating errors discovered on review, if any. Other Samples will not be returned, but the same notice will be given with respect thereto, and that notice shall be considered a return of the Sample.
- D. Contractor shall revise and resubmit any Sample(s), Shop Drawing(s), Product Data, and other submittal(s) as required by the reviewer. Such resubmittals will be reviewed and returned in the same manner as original Sample(s), Shop Drawing(s), Product Data, and other submittal(s), within five (5) days after receipt thereof or within five (5) days after receipt of all related information necessary for such review.
- E. Contractor may proceed with any of the Work covered by Sample(s), Shop Drawing(s), Product Data, and other submittal(s) upon its return if designated as no exception taken, or revise as noted, provided the Contractor proceeds in accordance with the Owner and/or the Architect's notes and comments.
- F. Contractor shall not begin any of the work covered by a Sample(s), Shop Drawing(s), Product Data, and other submittal(s), designated as revise and resubmit or rejected, until a revision or correction thereof has been reviewed and returned to Contractor.
- G. Sample(s), Shop Drawing(s), Product Data, and other submittal(s) designated as revise and resubmit or rejected and requiring resubmittal, shall be revised or corrected and resubmitted to the Owner no later than fourteen (14) days or a shorter period as required to comply with the approved Construction Schedule, after its return to Contractor.
- H. Neither the review nor the lack of review of any Sample(s), Shop Drawing(s), Product Data, and other submittal(s) shall waive any of the requirements of the Contract Documents, or relieve Contractor of any obligation thereunder.
- I. Owner's and/or Architect's review of Shop Drawings does not relieve the Contractor of responsibility for any errors that may exist. Contractor is responsible for the dimensions and design of adequate connections and details and for satisfactory construction of all the Work.

**PART 2 – PRODUCTS (Not Used)**

**PART 3 - EXECUTION (Not Used)**

END OF SECTION

## **SITE STANDARDS**

### **PART 1 – GENERAL**

#### **1.01 RELATED DOCUMENTS AND PROVISIONS:**

All Contract Documents should be reviewed for applicable provisions related to the provisions in this document, including without limitation:

- A. General Conditions, including without limitation, Safety Precautions and Programs, and Protection of Work and Property;
- B. Agreement;
- C. Drug-Free Workplace Certification; and
- D. Fingerprinting Notice and Acknowledgement.

#### **1.02 REQUIREMENTS OF THE OWNER:**

- A. Drug-Free Schools and Safety Requirements:
  - (1) All school sites and other Owner Facilities are “Drug-Free Zones.” No drugs, alcohol and/or smoking are allowed at any time in any buildings and/or grounds on Owner property. No students, staff, visitors, or contractors are to use drugs on these sites.
  - (2) Smoking and the use of tobacco products by all persons is prohibited on or in Owner property. Owner property includes school buildings, school grounds, school owned vehicles and vehicles owned by others while on Owner property. Contractor shall post: "Non-Smoking Area" in a highly visible location on Site. Contractor may designate a smoking area outside of Owner property within the public right-of-way, provided that this area remains quiet and unobtrusive to adjacent neighbors. This smoking area is to be kept clean at all times.
  - (3) Contractor shall ensure that no alcohol, firearms, weapons, or controlled substances enter or are used at the Site. Contractor shall immediately remove from the Site and terminate the employment of any employee(s) found in violation of this provision.
- B. Language: Unacceptable and/or loud language will not be tolerated. "Cat calls" or other derogatory language toward students or public will not be allowed.
- C. Disturbing the Peace (Noise and Lighting):

- (1) Contractor shall observe the noise ordinance of the Site at all times including, without limitation, all applicable local, city, and/or state laws, ordinances, and/or regulations regarding noise and allowable noise levels.
- (2) The use of radios, etc., shall be controlled to keep all sound at a level that cannot be heard beyond the immediate area of use. Owner reserves the right to prohibit the use of radios at the Site, except for handheld communication radios (e.g., Nextel phones or radios).
- (3) If portable lights are used after dark, all light must be located so as not to direct light into neighboring property.

D. Traffic:

- (1) Driving on the Premises shall be limited to periods when students and public are not present. If driving or deliveries must be made during the school hours, two (2) or more ground guides shall lead the vehicle across the area of travel. In no case shall driving take place across playgrounds or other pedestrian paths during recess, lunch, and/or class period changes. The speed limit on the Premises shall be five (5) miles per hour (maximum) or less if conditions require.
- (2) All paths of travel for deliveries, including without limitation, material, equipment, and supply deliveries, shall be reviewed and approved by Owner in advance. Any damage will be repaired to the pre-damaged condition by the Contractor.
- (3) Owner shall designate a construction entry to the Site. If Contractor requests, Owner determines it is required, and to the extent possible, Owner shall designate a staging area so as not to interfere with the normal functioning of school facilities. Location of gates and fencing shall be approved in advance with Owner and at Contractor's expense.
- (4) Parking areas shall be reviewed and approved by Owner in advance. No parking is to occur under the drip line of trees or in areas that could otherwise be damaged.

E. All of the above shall be observed and complied with by the Contractor and all workers on the Site. Failure to follow these directives could result in individual(s) being suspended or removed from the work force at the discretion of the Owner. The same rules and regulations shall apply equally to delivery personnel, inspectors, consultants, and other visitors to the Site.

**PART 2 - PRODUCTS (Not Used)**

**PART 3 - EXECUTION (Not Used)**

END OF SECTION

## QUALITY REQUIREMENTS

### PART 1 - GENERAL

#### 1.01 RELATED DOCUMENTS:

- A. Drawings, specifications and general provisions of the Contract, including General and Supplementary Conditions and other Division 01 Specification Sections, apply to this Section.

#### 1.02 SUMMARY:

- A. Section includes administrative and procedural requirements for quality assurance and quality control.
  - (1) Inspection of materials, products, fabrication and installation by DSA Field Representative.
  - (2) Inspection of materials, products, fabrication and installation by Owner's Inspector of Record
  - (3) Testing of materials, products, fabrication and installation by Owner's Testing Agency.
  - (4) Mock ups.
  - (5) Contractor's quality assurance and control services
  - (6) Other quality assurance and control services, as applicable.
- B. Testing and inspecting services are required to verify compliance with requirements specified or indicated. These services do not relieve Contractor of responsibility for compliance with the Contract Document requirements.
  - (1) Specific quality-assurance and -control requirements for individual construction activities are specified in the Sections that specify those activities. Requirements in those Sections may also cover production of standard products.
  - (2) Specified tests, inspections, and related actions do not limit Contractor's other quality-assurance and -control procedures that facilitate compliance with the Contract Document requirements.

- (3) Requirements for Contractor to provide quality-assurance and -control services required by Architect, Owner, or authorities having jurisdiction are not limited by provisions of this Section.
- (4) Specific test and inspection requirements are not specified in this Section.
- (5) Specified tests, inspections, and related actions do not limit Contractor's other quality-assurance and -control procedures that facilitate compliance with the Contract Document requirements or applicable building code requirements.
  - (a) Testing shall comply with the requirements of:
    - 1) California Building Code, Title 24, Part 1, Chapter 4, Section 4-335.
    - 2) Form DSA-103 "List of Required Structural Tests & Special Inspections– 2016 CBC."
    - 3) Requirements indicated in specification Sections Division 02 through 33.
    - 4) Other requirements of authorities having jurisdiction.

C. Related Requirements:

- (1) Section 01 21 00 "Allowances" for testing and inspecting allowances.
- (2) Section 01 32 00 "Construction Progress Documentation" for developing a schedule of required tests and inspections.
- (3) Divisions 02 through 33 Sections for specific test and inspection requirements.

**1.03 DEFINITIONS:**

- A. Quality-Assurance Services: Activities, actions, and procedures performed before and during execution of the Work to guard against defects and deficiencies and substantiate that proposed construction will comply with requirements.
- B. Quality-Control Services: Tests, inspections, procedures, and related actions during and after execution of the Work to evaluate that actual products incorporated into the Work and completed construction comply with

requirements. Services do not include contract enforcement activities performed by Architect.

- C. Mockups: Full-size physical assemblies that are constructed on-site. Mockups are constructed to verify selections made under Sample submittals; to demonstrate aesthetic effects and, where indicated, qualities of materials and execution; to review coordination, testing, or operation; to show interface between dissimilar materials; and to demonstrate compliance with specified installation tolerances. Mockups are not Samples. Unless otherwise indicated, approved mockups establish the standard by which the Work will be judged.
  - (1) Laboratory Mockups: Full-size physical assemblies constructed at testing facility to verify performance characteristics.
  - (2) Integrated Exterior Mockups: Mockups of the exterior envelope erected separately from the building but on Project site, consisting of multiple products, assemblies, and subassemblies.
  - (3) Room Mockups: Mockups of typical interior spaces complete with wall, floor, and ceiling finishes, doors, windows, millwork, casework, specialties, furnishings and equipment, and lighting.
- D. Preconstruction Testing: Tests and inspections performed specifically for Project before products and materials are incorporated into the Work, to verify performance or compliance with specified criteria.
- E. Product Testing: Tests and inspections that are performed by an NRTL, an NVLAP, or a testing agency qualified to conduct product testing and acceptable to authorities having jurisdiction, to establish product performance and compliance with specified requirements.
- F. Source Quality-Control Testing: Tests and inspections that are performed at the source, e.g., plant, mill, factory, or shop.
- G. Field Quality-Control Testing: Tests and inspections that are performed on-site for installation of the Work and for completed Work.
- H. Testing Agency: An entity engaged to perform specific tests, inspections, or both. Testing laboratory shall mean the same as testing agency.
- I. Installer/Applicator/Erector: Contractor or another entity engaged by Contractor as an employee, Subcontractor, or Sub-subcontractor, to perform a particular construction operation, including installation, erection, application, and similar operations.



- (1) Use of trade-specific terminology in referring to a trade or entity does not require that certain construction activities be performed by accredited or unionized individuals, or that requirements specified apply exclusively to specific trade(s).
  
- J. Experienced: When used with an entity or individual, "experienced" means having successfully completed a minimum of five previous projects similar in nature, size, and extent to this Project; being familiar with special requirements indicated; and having complied with requirements of authorities having jurisdiction.
  
- K. DSA: Division of the State Architect; the governing agency having jurisdiction.
  
- L. IOR: Inspector of Record; Inspector certified through the DSA Project Inspector certification program and approved for the project.

#### **1.04 CONFLICTING REQUIREMENTS:**

- A. Referenced Standards: If compliance with two or more standards is specified and the standards establish different or conflicting requirements for minimum quantities or quality levels, comply with the most stringent requirement. Refer conflicting requirements that are different, but apparently equal, to Architect for a decision before proceeding.
  
- B. Minimum Quantity or Quality Levels: The quantity or quality level shown or specified shall be the minimum provided or performed. The actual installation may comply exactly with the minimum quantity or quality specified, or it may exceed the minimum within reasonable limits. To comply with these requirements, indicated numeric values are minimum or maximum, as appropriate, for the context of requirements. Refer uncertainties to Architect for a decision before proceeding.

#### **1.05 ACTION SUBMITTALS:**

- A. Shop Drawings: For mockups, provide plans, sections, and elevations, indicating materials and size of mockup construction.
  - (1) Indicate manufacturer and model number of individual components.
  - (2) Provide axonometric drawings for conditions difficult to illustrate in two dimensions.

#### **1.06 INFORMATIONAL SUBMITTALS:**

- A. Contractor's Quality-Control Plan: For quality-assurance and quality-control activities and responsibilities.

- B. Qualification Data: For Contractor's quality-control personnel.
- C. Contractor's Statement of Responsibility: When required by authorities having jurisdiction, submit copy of written statement of responsibility sent to authorities having jurisdiction before starting work on the following systems:
  - (1) Seismic-force-resisting system, designated seismic system, or component listed in the designated seismic system quality-assurance plan prepared by Architect.
  - (2) Main wind-force-resisting system or a wind-resisting component listed in the wind- force-resisting system quality-assurance plan prepared by Architect.
- D. Testing Agency Qualifications: For testing agencies specified in "Quality Assurance" Article to demonstrate their capabilities and experience. Include proof of qualifications in the form of a recent report on the inspection of the testing agency by a recognized authority.
- E. Schedule of Tests and Inspections: Prepare in tabular form and include the following:
  - (1) Specification Section number and title.
  - (2) Entity responsible for performing tests and inspections.
  - (3) Description of test and inspection.
  - (4) Identification of applicable standards.
  - (5) Identification of test and inspection methods.
  - (6) Number of tests and inspections required.
  - (7) Time schedule or time span for tests and inspections.
  - (8) Requirements for obtaining samples.
  - (9) Unique characteristics of each quality-control service.

#### **1.07 CONTRACTOR'S QUALITY-CONTROL PLAN**

- A. Quality-Control Plan, General: Submit quality-control plan within 10 days of Notice to Proceed, and not less than five days prior to preconstruction conference. Submit in format acceptable to Architect. Identify personnel, procedures, controls, instructions, tests, records, and forms to be used to carry out Contractor's quality-assurance and quality- control responsibilities. Coordinate with Contractor's construction schedule.

- B. Quality-Control Personnel Qualifications: Engage qualified full-time personnel trained and experienced in managing and executing quality-assurance and quality-control procedures similar in nature and extent to those required for Project.
  - (1) Project quality-control manager may also serve as Project superintendent.
- C. Submittal Procedure: Describe procedures for ensuring compliance with requirements through review and management of submittal process. Indicate qualifications of personnel responsible for submittal review.
- D. Testing and Inspection: In quality-control plan, include a comprehensive schedule of Work requiring testing or inspection, including the following:
  - (1) Contractor-performed tests and inspections including subcontractor-performed tests and inspections. Include required tests and inspections and Contractor-elected tests and inspections.
  - (2) Special inspections required by authorities having jurisdiction and indicated on the "Statement of Special Inspections."
  - (3) Owner-performed tests and inspections indicated in the Contract Documents.
- E. Continuous Inspection of Workmanship: Describe process for continuous inspection during construction to identify and correct deficiencies in workmanship in addition to testing and inspection specified. Indicate types of corrective actions to be required to bring work into compliance with standards of workmanship established by Contract requirements and approved mockups.
- F. Monitoring and Documentation: Maintain testing and inspection reports including log of approved and rejected results. Include work Architect has indicated as nonconforming or defective. Indicate corrective actions taken to bring nonconforming work into compliance with requirements. Comply with requirements of authorities having jurisdiction.

## **1.08 REPORTS AND DOCUMENTS**

- A. Test and Inspection Reports: Prepare and submit certified written reports specified in other Sections. Include the following:
  - (1) Date of issue.
  - (2) Project title and number.
  - (3) Name, address, and telephone number of testing agency.
  - (4) Dates and locations of samples and tests or inspections.

- (5) Names of individuals making tests and inspections.
- (6) Description of the Work and test and inspection method.
- (7) Identification of product and Specification Section.
- (8) Complete test or inspection data.
- (9) Test and inspection results and an interpretation of test results.
- (10) Record of temperature and weather conditions at time of sample taking and testing and inspecting.
- (11) Comments or professional opinion on whether tested or inspected Work complies with the Contract Document requirements.
- (12) Name and signature of laboratory inspector.
- (13) Recommendations on retesting and reinspecting.

B. Manufacturer's Technical Representative's Field Reports: Prepare written information documenting manufacturer's technical representative's tests and inspections specified in other Sections. Include the following:

- (1) Name, address, and telephone number of technical representative making report.
- (2) Statement on condition of substrates and their acceptability for installation of product.
- (3) Statement that products at Project site comply with requirements.
- (4) Summary of installation procedures being followed, whether they comply with requirements and, if not, what corrective action was taken.
- (5) Results of operational and other tests and a statement of whether observed performance complies with requirements.
- (6) Statement whether conditions, products, and installation will affect warranty.
- (7) Other required items indicated in individual Specification Sections.

- C. Factory-Authorized Service Representative's Reports: Prepare written information documenting manufacturer's factory-authorized service representative's tests and inspections specified in other Sections. Include the following:
  - (1) Name, address, and telephone number of factory-authorized service representative making report.
  - (2) Statement that equipment complies with requirements.
  - (3) Results of operational and other tests and a statement of whether observed performance complies with requirements.
  - (4) Statement whether conditions, products, and installation will affect warranty.
  - (5) Other required items indicated in individual Specification Sections.

## 1.09 QUALITY ASSURANCE

- A. General: Qualifications paragraphs in this article establish the minimum qualification levels required; individual Specification Sections specify additional requirements.
- B. Manufacturer Qualifications: A firm experienced in manufacturing products or systems similar to those indicated for this Project and with a record of successful in-service performance, as well as sufficient production capacity to produce required units.
- C. Fabricator Qualifications: A firm experienced in producing products similar to those indicated for this Project and with a record of successful in-service performance, as well as sufficient production capacity to produce required units.
- D. Installer Qualifications: A firm or individual experienced in installing, erecting, or assembling work similar in material, design, and extent to that indicated for this Project, whose work has resulted in construction with a record of successful in-service performance.
- E. Professional Engineer Qualifications: A professional engineer who is legally qualified to practice in jurisdiction where Project is located and who is experienced in providing engineering services of the kind indicated. Engineering services are defined as those performed for installations of the system, assembly, or product that are similar in material, design, and extent to those indicated for this Project.
- F. Specialists: Certain Specification Sections require that specific construction activities shall be performed by entities who are recognized experts in those operations. Specialists shall satisfy qualification requirements indicated and shall be engaged for the activities indicated.

- (1) Requirements of authorities having jurisdiction shall supersede requirements for specialists.
- G. Testing Agency Qualifications: An NRTL, an NVLAP, or an independent agency with the experience and capability to conduct testing and inspecting indicated, as documented according to ASTM E 329; and with additional qualifications specified in individual Sections; and, where required by authorities having jurisdiction, that is acceptable to authorities.
- (1) NRTL: A nationally recognized testing laboratory according to 29 CFR 1910.7.
  - (2) NVLAP: A testing agency accredited according to NIST's National Voluntary Laboratory Accreditation Program.
- H. Manufacturer's Technical Representative Qualifications: An authorized representative of manufacturer who is trained and approved by manufacturer to observe and inspect installation of manufacturer's products that are similar in material, design, and extent to those indicated for this Project.
- I. Factory-Authorized Service Representative Qualifications: An authorized representative of manufacturer who is trained and approved by manufacturer to inspect installation of manufacturer's products that are similar in material, design, and extent to those indicated for this Project.
- J. Preconstruction Testing: Where testing agency is indicated to perform preconstruction testing for compliance with specified requirements for performance and test methods, comply with the following:
- (1) Contractor responsibilities include the following:
    - (a) Provide test specimens representative of proposed products and construction.
    - (b) Submit specimens in a timely manner with sufficient time for testing and analyzing results to prevent delaying the Work.
    - (c) Provide sizes and configurations of test assemblies, mockups, and laboratory mockups to adequately demonstrate capability of products to comply with performance requirements.
    - (d) Build site-assembled test assemblies and mockups using installers who will perform same tasks for Project.

- (e) Build laboratory mockups at testing facility using personnel, products, and methods of construction indicated for the completed Work.
    - (f) When testing is complete, remove test specimens, assemblies, and mockups; do not reuse products on Project.
  - (2) Testing Agency Responsibilities: Submit a certified written report of each test, inspection, and similar quality-assurance service to Architect, with copy to Contractor. Interpret tests and inspections and state in each report whether tested and inspected work complies with or deviates from the Contract Documents.
- K. Mockups: Before installing portions of the Work requiring mockups, build mockups for each form of construction and finish required to comply with the following requirements, using materials indicated for the completed Work:
- (1) Build mockups in location and of size indicated or, if not indicated, as directed by Architect.
  - (2) Notify Architect seven days in advance of dates and times when mockups will be constructed.
  - (3) Employ supervisory personnel who will oversee mockup construction. Employ workers that will be employed during the construction at Project.
  - (4) Demonstrate the proposed range of aesthetic effects and workmanship.
  - (5) Obtain Architect's approval of mockups before starting work, fabrication, or construction.
    - (a) Allow seven days for initial review and each re-review of each mockup.
  - (6) Maintain mockups during construction in an undisturbed condition as a standard for judging the completed Work.
  - (7) Demolish and remove mockups when directed unless otherwise indicated.
- L. Integrated Exterior Mockups: Construct integrated exterior mockup as indicated on Drawings. Coordinate installation of exterior envelope materials and products for which mockups are required in individual Specification Sections, along with supporting materials.

## 1.10 QUALITY CONTROL

- A. Owner Responsibilities: Where quality-control services are indicated as Owner's responsibility, Owner will engage a qualified testing agency to perform these services.
- (1) Owner will furnish Contractor with names, addresses, and telephone numbers of testing agencies engaged and a description of types of testing and inspecting they are engaged to perform.
  - (2) Payment for these services will be made from testing and inspecting allowances, as authorized by Change Orders.
  - (3) Costs for retesting and reinspecting construction that replaces or is necessitated by work that failed to comply with the Contract Documents will be charged to Contractor, and the Contract Sum will be adjusted by Change Order.
- B. Contractor Responsibilities: Tests and inspections not explicitly assigned to Owner are Contractor's responsibility. Perform additional quality-control activities required to verify that the Work complies with requirements, whether specified or not.
- (1) Unless otherwise indicated, provide quality-control services specified and those required by authorities having jurisdiction. Perform quality-control services required of Contractor by authorities having jurisdiction, whether specified or not.
  - (2) Where services are indicated as Contractor's responsibility, engage a qualified testing agency to perform these quality-control services.
    - (a) Contractor shall not employ same entity engaged by Owner, unless agreed to in writing by Owner.
  - (3) Notify testing agencies at least 24 hours in advance of time when Work that requires testing or inspecting will be performed.
  - (4) Where quality-control services are indicated as Contractor's responsibility, submit a certified written report, in duplicate, of each quality-control service.
  - (5) Testing and inspecting requested by Contractor and not required by the Contract Documents are Contractor's responsibility.



- (6) Submit additional copies of each written report directly to authorities having jurisdiction, when they so direct.
- C. **Manufacturer's Field Services:** Where indicated, engage a factory-authorized service representative to inspect field-assembled components and equipment installation, including service connections. Report results in writing as specified in Section 01 33 00 "Submittals."
- D. **Manufacturer's Technical Services:** Where indicated, engage a manufacturer's technical representative to observe and inspect the Work. Manufacturer's technical representative's services include participation in preinstallation conferences, examination of substrates and conditions, verification of materials, observation of Installer activities, inspection of completed portions of the Work, and submittal of written reports.
- E. **Retesting/Reinspecting:** Regardless of whether original tests or inspections were Contractor's responsibility, provide quality-control services, including retesting and reinspecting, for construction that replaced Work that failed to comply with the Contract Documents.
- F. **Testing Agency Responsibilities:** Cooperate with Architect and Contractor in performance of duties. Provide qualified personnel to perform required tests and inspections.
  - (1) Notify Architect and Contractor promptly of irregularities or deficiencies observed in the Work during performance of its services.
  - (2) Determine the location from which test samples will be taken and in which in-situ tests are conducted.
  - (3) Conduct and interpret tests and inspections and state in each report whether tested and inspected work complies with or deviates from requirements.
  - (4) Submit a certified written report, in duplicate, of each test, inspection, and similar quality-control service through Contractor.
  - (5) Do not release, revoke, alter, or increase the Contract Document requirements or approve or accept any portion of the Work.
  - (6) Do not perform any duties of Contractor.
- G. **Associated Services:** Cooperate with agencies performing required tests, inspections, and similar quality-control services, and provide reasonable auxiliary

services as requested. Notify agency sufficiently in advance of operations to permit assignment of personnel. Provide the following:

- (1) Access to the Work.
  - (2) Incidental labor and facilities necessary to facilitate tests and inspections.
  - (3) Adequate quantities of representative samples of materials that require testing and inspecting. Assist agency in obtaining samples.
  - (4) Facilities for storage and field curing of test samples.
  - (5) Delivery of samples to testing agencies.
  - (6) Preliminary design mix proposed for use for material mixes that require control by testing agency.
  - (7) Security and protection for samples and for testing and inspecting equipment at Project site.
- H. Coordination: Coordinate sequence of activities to accommodate required quality-assurance and -control services with a minimum of delay and to avoid necessity of removing and replacing construction to accommodate testing and inspecting.
- (1) Schedule times for tests, inspections, obtaining samples, and similar activities.

## **1.11 SPECIAL TESTS AND INSPECTIONS**

- A. Special Tests and Inspections: Conducted by a qualified testing agency and/or special inspector as required by authorities having jurisdiction, as indicated in individual Specification Sections and in Statement of Special Inspections attached to this Section, and as follows:
- (1) Verifying that manufacturer maintains detailed fabrication and quality-control procedures and reviews the completeness and adequacy of those procedures to perform the Work.
  - (2) Notifying Architect and Contractor promptly of irregularities and deficiencies observed in the Work during performance of its services.
  - (3) Submitting a certified written report of each test, inspection, and similar quality- control service to Architect with copy to Contractor and to authorities having jurisdiction.

- (4) Submitting a final report of special tests and inspections at Substantial Completion, which includes a list of unresolved deficiencies.
- (5) Interpreting tests and inspections and stating in each report whether tested and inspected work complies with or deviates from the Contract Documents.
- (6) Retesting and reinspecting corrected work.

## **PART 2 – PRODUCTS (Not Used)**

## **PART 3 – EXECUTION**

### **3.01 TEST AND INSPECTION LOG**

- A. Test and Inspection Log: Prepare a record of tests and inspections. Include the following:
  - (1) Date test or inspection was conducted.
  - (2) Description of the Work tested or inspected.
  - (3) Date test or inspection results were transmitted to Architect.
  - (4) Identification of testing agency or special inspector conducting test or inspection.
- B. Maintain log at Project site. Post changes and revisions as they occur. Provide access to test and inspection log for Architect's reference during normal working hours.

### **3.02 REPAIR AND PROTECTION**

- A. General: On completion of testing, inspecting, sample taking, and similar services, repair damaged construction and restore substrates and finishes.
  - (1) Provide materials and comply with installation requirements specified in other Specification Sections or matching existing substrates and finishes. Restore patched areas and extend restoration into adjoining areas with durable seams that are as invisible as possible. Comply with the Contract Document requirements for cutting and patching in Section 01 73 00 "Execution."

- B. Protect construction exposed by or for quality-control service activities.
- C. Repair and protection are Contractor's responsibility, regardless of the assignment of responsibility for quality-control services.

END OF SECTION

## **REGULATORY REQUIREMENTS**

### **PART 1 - GENERAL**

#### **1.01 RELATED DOCUMENTS AND PROVISIONS:**

All Contract Documents should be reviewed for applicable provisions related to the provisions in this document, including without limitation the General Conditions

#### **1.02 DESCRIPTION:**

This section covers the general requirements for regulatory requirements pertaining to the Work and is supplementary to all other regulatory requirements mentioned or referenced elsewhere in the Contract Documents.

#### **1.03 REQUIREMENTS OF REGULATORY AGENCIES:**

- A. All statutes, ordinances, laws, rules, codes, regulations, standards, and the lawful orders of all public authorities having jurisdiction of the Work, are hereby incorporated into these Contract Documents as if repeated in full herein and are intended to be included in any reference to Code or Building Code, unless otherwise specified, including, without limitation, the references in the list below. Contractor shall make available at the Site copies of all the listed documents applicable to the Work as the Owner and/or Architect may request, including, without limitation, applicable portions of the California Code of Regulations ("CCR").
- B. This Project shall be governed by applicable regulations, including, without limitation, the State of California's Administrative Regulations for the Division of the State Architect-Structural Safety (DSA/SS), Chapter 4, Part 1, Title 24, CCR, and the most current version on the date the bids are opened and as it pertains to school construction including, without limitation:
  - (1) Test and testing laboratory per Section 4-335 (Owner shall pay for the testing laboratory.)
  - (2) Special inspections per Section 4-333(c).
  - (3) Verified reports per Section 4-365 & 4-343(c).
  - (4) Duties of the Architect & Engineers shall be per Section 4-333(a) and 4-341.
  - (5) Duties of the Contractor shall be per Section 4-343.
  - (6) Addenda and Change Orders per Section 4-338.

Contractor shall keep and make available a copy of Part 1 and 2 of the most current version of Title 24 at the Site during construction.

- C. Items of deferred approval shall be clearly marked on the first sheet of the Architect's and/or Engineer's approved Drawings. All items later submitted for approval shall be per Title 24 requirements to the DSA.
- (1) Building Standards Administrative Code, Part 1, Title 24, CCR
  - (2) California Building Code (CBC), Part 2, Title 24, CCR; (Uniform Building code volumes 1-3 and California Amendments).
  - (3) California Electrical Code (CEC), Part 3, Title 24, CCR; (National Electrical Code and California Amendments).
  - (4) California Mechanical Code (CMC), Part 4, Title 24, CCR; (Uniform Mechanical Code and California Amendments).
  - (5) California Plumbing Code (CPC), Part 5, Title 24, CCR; (Uniform Plumbing Code and California Amendments).
  - (6) California Fire Code (CFC), Part 9, Title 24, CCR; (Fire Plumbing Code and California Amendments).
  - (7) California Referenced Standards Code, Part 12, Title 24, CCR.
  - (8) State Fire Marshal Regulations, Public Safety, Title 19, CCR.
  - (9) Partial List of Applicable NFPA Standards:
    - (a) NFPA 13 - Automatic Sprinkler System.
    - (b) NFPA 14 - Standpipes Systems.
    - (c) NFPA 17A - Wet Chemical System
    - (d) NFPA 24 - Private Fire Mains.
    - (e) (California Amended) NFPA 72 - National Fire Alarm Codes.
    - (f) NFPA 253 - Critical Radiant Flux of Floor Covering System.
    - (g) NFPA 2001 - Clean Agent Fire Extinguishing Systems.
  - (10) California Division of the State Architect interpretation of Regulations.

**PART 2 – PRODUCTS (Not Used)**

**PART 3 – EXECUTION (Not Used)**

END OF SECTION

## ABBREVIATIONS AND ACRONYMS

### PART 1 – GENERAL

#### 1.01 RELATED DOCUMENTS AND PROVISIONS:

All Contract Documents should be reviewed for applicable provisions related to the provisions in this document, including without limitation the General Conditions and Agreement.

#### 1.02 DOCUMENT INCLUDES:

- A. Abbreviations used throughout the Contract Documents.
- B. Reference to a technical society, organization, or body is by abbreviation, as follows:

1.	AA	Aluminum Association
2.	AAMA	Architectural Aluminum Manufacturers Association
3.	AASHTO	American Association of State Highway and Transportation Officials
4.	ABPA	Acoustical and Board Products Association
5.	ACI	American Concrete Institute
6.	AGA	American Gas Association
7.	AGC	Associated General Contractors
8.	AHC	Architectural Hardware Consultant
9.	AI	Asphalt Institute
10.	AIA	American Institute of Architects
11.	AIEE	American Institute of Electrical Engineers
12.	AISC	American Institute of Steel Construction
13.	AISI	American Iron and Steel Institute
14.	AMCA	Air Moving and Conditioning Association
15.	ANSI	American National Standards Institute
16.	APA	American Plywood Association
17.	ARI	Air Conditioning and Refrigeration Institute
18.	ASHRAE	American Society of Heating, Refrigeration and Air Conditioning Engineers
19.	ASME	American Society of Mechanical Engineers
20.	ASSE	American Society of Structural Engineers
21.	ASTM	American Society of Testing and Materials
22.	AWPB	American Wood Preservers Bureau
23.	AWPI	American Wood preservers Institute
24.	AWS	American Welding Society
25.	AWSC	American Welding Society Code
26.	AWI	Architectural Woodwork Institute
27.	AWWA	American Water Works Association



28.	BIA	Brick Institute of America
29.	CBC	California Building Code
30.	CLFMI	Chain Link Fence Manufacturers Institute
31.	CMG	California Masonry Guild
32.	CRA	California Redwood Association
33.	CRSI	Concrete Reinforcing Steel Institute
34.	CS	Commercial Standards
35.	CSI	Construction Specifications Institute
36.	CTI	Cooling Tower Institute
37.	FGMA	Flat Glass Manufacturer's Association
38.	FIA	Factory Insurance Association
39.	FM	Factory Mutual
40.	FS	Federal Specification
41.	FTI	Facing Title Institute
42.	GA	Gypsum Association
43.	ICC	International Code Council
44.	IEEE	Institute of Electrical and Electronic Engineers
45.	IES	Illumination Engineering Society
46.	LIA	Lead Industries Association
47.	MIA	Marble Institute of America
48.	MLMA	Metal Lath Manufacturers Association
49.	MS	Military Specifications
50.	NAAMM	National Association of Architectural Metal Manufacturers
51.	NBHA	National Builders Hardware Association
52.	NBFU	National Board of Fire Underwriters
53.	NBS	National Bureau of Standards
54.	NCMA	National Concrete Masonry Association
55.	NEC	National Electrical Code
56.	NEMA	National Electrical Manufacturers Association
57.	NFPA	National Fire Protection Association/National Forest Products Association
58.	NMWIA	National Mineral Wool Insulation Association
59.	NTMA	National Terrazzo and Mosaic Association
60.	NWMA	National Woodwork Manufacturer's Association
61.	ORS	Office of Regulatory Services (California)
62.	OSHA	Occupational Safety and Health Act
63.	PCI	Precast Concrete Institute
64.	PCA	Portland Cement Association
65.	PDCA	Painting and Decorating Contractors of America
66.	PDI	Plumbing Drainage Institute
67.	PEI	Porcelain Enamel Institute
68.	PG&E	Pacific Gas & Electric Company
69.	PS	Product Standards
70.	SDI	Steel Door Institute; Steel Deck Institute

71.	SJI	Steel Joist Institute
72.	SSPC	Steel Structures Painting Council
73.	TCA	Tile Council of America
74.	TPI	Truss Plate Institute
75.	UBC	Uniform Building Code
76.	UL	Underwriters Laboratories Code
77.	UMC	Uniform Mechanical Code
78.	USDA	United States Department of Agriculture
79.	VI	Vermiculite Institute
80.	WCLA	West Coast Lumberman's Association
81.	WCLB	West Coast Lumber Bureau
82.	WEUSER	Western Electric Utilities Service Engineering Requirements
83.	WIC	Woodwork Institute of California
84.	WPOA	Western Plumbing Officials Association

**PART 2 - PRODUCTS (Not Used)**

**PART 3 - EXECUTION (Not Used)**

END OF SECTION

## QUALITY ASSURANCE

### PART 1 - GENERAL

#### 1.01 RELATED DOCUMENTS AND PROVISION

All Contract Documents should be reviewed for applicable provisions related to the provisions in this document, including without limitation the General Conditions and Agreement

#### 1.02 QUALITY ASSURANCE:

- A. For products or workmanship specified by association, trade, or Federal Standards, Contractor shall comply with requirements of the standard, except when more rigid requirements are specified in the Contract Documents, or are required by applicable codes.
- B. Contractor shall conform to current reference standard publication date in effect on the date of bid opening.
- C. Contractor shall obtain copies of standards unless specifically required not to by the Contract Documents.
- D. Contractor shall maintain a copy of all standards at jobsite during submittals, planning, and progress of the specific Work, until final completion, unless specifically required not to by the Contract Documents.
- E. Should specified reference standards conflict with Contract Documents, Contractor shall request clarification from the Owner and/or the Architect before proceeding.
- F. The contractual relationship of the parties to the Contract shall not be altered from the contractual relationship as indicated in the Contract Documents by mention or inference otherwise in any referenced document.
- G. Governing Codes shall be as shown in the Contract Documents including, without limitation, the Specifications.

END OF SECTION

## **REFERENCES**

### **PART 1 - GENERAL**

#### **1.01 SCHEDULE OF REFERENCES:**

**The following information is intended only for the general assistance of the Contractor, and the Owner does not represent that all of the information is current. It is the Contractor's responsibility to verify the correct information for each of the entities listed.**

AA	Aluminum Association 1525 Wilson Blvd., Suite 600 Arlington, VA 22209 <a href="http://www.aluminum.org">www.aluminum.org</a>	703/358-2960
----	---	--------------

AABC	Associated Air Balance Council 1518 K Street, NW, Suite 503 Washington, DC 20005 <a href="http://www.aabchq.com">www.aabchq.com</a>	202/737-0202
------	--	--------------

AAMA	<p>American Architectural Manufacturers Association  1827 Walden Office Sq., Suite 550  Schaumburg, IL 60173-4268  <a href="http://www.aamanet.org">www.aamanet.org</a></p>	847/303-5664
AASHTO	<p>American Association of State Highway and  Transportation Officials  444 N Capitol St. NW - Suite 249  Washington, DC 20001  <a href="http://www.transportation.org">www.transportation.org</a></p>	202/624-5800

AATCC	American Association of Textile Chemists and Colorists P.O. Box 12215 One Davis Drive Research Triangle Park, NC 27709 2215 <a href="http://www.aatcc.org">www.aatcc.org</a>	919/549-8141
ACA	American Coatings Association 1500 Rhode Island Ave., NW Washington DC, 20005 <a href="http://www.paint.org">www.paint.org</a>	202/462-6272
ACI	American Concrete Institute 38800 Country Club Dr. Farmington Hills, MI 48331-3439 <a href="http://www.aci-int.org">www.aci-int.org</a>	248/848-3700
ACPA	American Concrete Pipe Association 8445 Freeport Parkway, Suite 350 Irving, TX 75063-2595 <a href="http://www.concrete-pipe.org">www.concrete-pipe.org</a>	972/506-7216
ADC	Air Diffusion Council 1901 N. Roselle Road, Suite 800 Schaumburg, Illinois 60195 <a href="http://www.flexibleduct.org">www.flexibleduct.org</a>	847/706-6750
AF&PA	American Forest and Paper Association 1111 Nineteenth Street, NW, Suite 800 Washington, DC 20036 <a href="http://www.afandpa.org">www.afandpa.org</a>	202/463-2700



AGA	American Gas Association 400 North Capitol Street, NW Washington, DC 20001 <a href="http://www.aga.org">www.aga.org</a>	202/824-7000
AGC	Associate General Contractors of America 2300 Wilson Blvd., Suite 400 Arlington, VA 22201 <a href="http://www.agc.org">www.agc.org</a>	703/548-3118
AHA	American Hardboard Association 1210 West Northwest Highway Palatine, IL 60067 <a href="http://domensino.com/AHA/default.htm">domensino.com/AHA/default.htm</a>	847/934-8800
AI	Asphalt Institute 2696 Research Park Drive Lexington, KY 40511-8480 <a href="http://www.asphaltinstitute.org">www.asphaltinstitute.org</a>	859/288-4960
AIA	The American Institute of Architects 1735 New York Ave., NW Washington, DC 20006-5292 <a href="http://www.aia.org">www.aia.org</a>	202/626-7300
AISC	American Institute of Steel Construction One East Wacker Drive Suite 700 Chicago, IL 60601-1802 <a href="http://www.aisc.org">www.aisc.org</a>	312.670.2400
AIA	American Insurance Association (formerly the National Board of Fire Underwriters) 2101 L Street, NW, Suite 400 Washington, DC 20037 <a href="http://www.aiadc.org">www.aiadc.org</a>	202/828-7100
AISI	American Iron and Steel Institute 25 Massachusetts Ave., NW, Suite 800 Washington, DC 20001 <a href="http://www.steel.org">www.steel.org</a>	202/452.7100
AITC	American Institute of Timber Construction 7012 S. Revere Parkway Suite 140 Centennial, CO 80112 <a href="http://www.aitc-glulam.org">www.aitc-glulam.org</a>	303/792.9559

ALI	Associated Laboratories, Inc. P.O. Box 152837 Dallas, TX 75315 www.assoc-labs.com	214/565-0593
ALSC	American Lumber Standards Committee, Inc. P.O. Box 210 Germantown, MD 20875 www.alsc.org	301/972-1700
AMCA	Air Movement and Control Association International, Inc. 30 W. University Drive Arlington Heights, IL 60004 www.amca.org	847/394-0150
ANLA	American Nursery & Landscape Association 1200 G Street NW, Suite 800 Washington, DC 20005 www.anla.org	202/789-2900
ANSI	American National Standards Institute 1899 L Street, NW, 11th Floor Washington, DC, 20036 www.ansi.org	202/293.8020
APA	APA-The Engineered Wood Association 7011 S. 19th Street Tacoma, WA 98466-5333 www.apawood.org	253/565-6600
APA	Architectural Precast Association 6710 Winkler Road, Suite 8 Fort Myers, Florida 33919 www.archprecast.org	239/454-6989
ARI	Air Conditioning and Refrigeration Institute 4100 N. Fairfax Drive, Suite 200 Arlington, VA 22203 www.lightindustries.com/ARI	703/524-8800

ARMA	Asphalt Roofing Manufacturers Association Public Information Department 750 National Press Building 529 14th Street, NW Washington, DC 20045 <a href="http://www.asphaltroofing.org">www.asphaltroofing.org</a>	202/591-2450
ASA	The Acoustical Society of America ASA Office Manager Suite 1NO1 2 Huntington Quadrangle Melville, NY 11747-4502 <a href="http://asa.aip.org">http://asa.aip.org</a>	516/576-2360
ASCE	American Society of Civil Engineers 1801 Alexander Bell Drive Reston, VA 20191 <a href="http://www.asce.org">www.asce.org</a>	800/548-2723 703/295-6300
ASHRAE	American Society of Heating, Refrigerating and Air Conditioning Engineers 1791 Tullie Circle, NE Atlanta, GA 30329-2305 <a href="http://www.ashrae.org">www.ashrae.org</a>	800/527-4723 404/636-8400
ASLA	American Society of Landscape Architects 636 Eye Street, NW Washington, DC 20001-3736 <a href="http://www.asla.org">www.asla.org</a>	202/898-2444
ASME	American Society of Mechanical Engineers Three Park Avenue New York, NY 10016-5990 <a href="http://www.asme.org">www.asme.org</a>	800/434-2763
ASPE	American Society of Plumbing Engineers 2980 S River Rd. Des Plaines, IL 60018 <a href="http://aspe.org">http://aspe.org</a>	847/296-0002

ASQ	American Society for Quality P.O. Box 3005 Milwaukee, WI 53201-3005 or 600 North Plankinton Avenue Milwaukee, WI 53203 <a href="http://asq.org">http://asq.org</a>	800/248-1946 414/272-8575
ASSE	American Society of Sanitary Engineering 901 Canterbury, Suite A Westlake, Ohio 44145 <a href="http://www.asse-plumbing.org">www.asse-plumbing.org</a>	440/835-3040
ASTM	ASTM International 100 Barr Harbor Drive PO Box C700 West Conshohocken, PA, 19428-2959 <a href="http://www.astm.org">www.astm.org</a>	610/832-9500
AWCI	Association of the Wall and Ceiling Industry 513 West Broad Street, Suite 210 Falls Church, VA 22046 <a href="http://www.awci.org">www.awci.org</a>	703/538-1600
AWPA	American Wood Protection Association P.O. Box 361784 Birmingham, AL 35236-1784 <a href="http://www.awpa.com">www.awpa.com</a>	205/733-4077
AWPI	American Wood Preservers Institute 2750 Prosperity Ave. Suite 550 Fairfax, VA 22031-4312 <a href="http://www.arcat.com">www.arcat.com</a>	800/356-AWPI 703/204-0500
AWS	American Welding Society 8669 Doral Boulevard, Suite 130 Doral, Florida 33166 <a href="http://www.aws.org">www.aws.org</a>	800/443-9353 305/443-9353
AWI	Architectural Woodwork Institute 46179 Westlake Drive, Suite 120 Potomac Falls, VA 20165-5874 <a href="http://www.awinet.org">www.awinet.org</a>	571/323-3636

AWWA	American Water Works Association 6666 West Quincy Avenue Denver, CO 80235 <a href="http://www.awwa.org">www.awwa.org</a>	800/926-7337 303/794 7711
BHMA	Builders Hardware Manufacturers Association 355 Lexington Avenue, 15th floor New York, NY 10017 <a href="http://www.buildershardware.com">www.buildershardware.com</a>	212/297-2122
BIA	The Brick Industry Association 1850 Centennial Park Drive, Suite 301 Reston, VA 20191 <a href="http://www.gobrick.com">www.gobrick.com</a>	703/620-0010
CGA	Compressed Gas Association 14501 George Carter Way, Suite 103 Chantilly VA 20151-2923 <a href="http://www.cganet.com">www.cganet.com</a>	703/788-2700
CISCA	Ceilings & Interior Systems Construction Association 1010 Jorie Blvd, Suite 30 Oak Brook, IL 60523 <a href="http://www.cisca.org">www.cisca.org</a>	630/584-1919
CISPI	Cast Iron Soil Pipe Institute 1064 Delaware Avenue SE Atlanta, GA 30316 <a href="http://www.cispi.org">www.cispi.org</a>	404/622-0073
CLFMI	Chain Link Fence Manufacturers Institute 10015 Old Columbia Road, Suite B-215 Columbia, MD 21046 <a href="http://www.associationsites.com/main-pub.cfm?usr=clfma">www.associationsites.com/main-pub.cfm?usr=clfma</a>	410/290-6267
CPA	Composite Panel Association 19465 Deerfield Avenue, Suite 306 Leesburg, VA 20176 <a href="http://www.compositepanel.org">www.compositepanel.org</a>	703/724-1128
CPSC	Consumer Product Safety Commission 4330 East West Highway Bethesda, MD 20814 <a href="http://www.cpsc.gov">www.cpsc.gov</a>	301/504-7923 800/638-2772

CRA	California Redwood Association 405 Enfrente Drive, Suite 200 Novato, CA 94949 www.calredwood.org	415/382-0662
CRI	Carpet and Rug Institute P.O. Box 2048 Dalton, Georgia 30722-2048 www.carpet-rug.org	706/278-3176
CRSI	Concrete Reinforcing Steel Institute 933 N. Plum Grove Road Schaumburg, IL 60173 4758 www.crsi.org	847/517-1200
CSI	The Construction Specifications Institute 110 South Union Street, Suite 100 Alexandria VA 22314 www.csinet.org	800/689-2900
CTIOA	Ceramic Tile Institute of America 12061 Jefferson Blvd. Culver City, CA 90230-6219 www.ctioa.org	310/574-7800
DHI	Door and Hardware Institute (formerly National Builders Hardware Association) 14150 Newbrook Dr. Chantilly, VA 20151 www.dhi.org	703/222-2010
DIPRA	Ductile Iron Pipe Research Association 2000 2nd Avenue, South Suite 429 Birmingham, AL 35233 www.dipra.org	205/402-8700
DOC	U.S. Department of Commerce 1401 Constitution Ave., NW Washington, D.C. 20230 www.commerce.gov	202/482-2000

DOT	U.S. Department of Transportation 1200 New Jersey Avenue, SE Washington, DC 20590 www.dot.gov	855/368-4200
EJMA	Expansion Joint Manufacturers Association, Inc. 25 North Broadway Tarrytown, NY 10591 www.ejma.org	914/332-0040
EPA	Environmental Protection Agency Ariel Rios Building 1200 Pennsylvania Avenue, N.W. Washington, DC 20460 www.epa.gov	202/272-0167
FCICA	Floor Covering Installation Contractors Association 7439 Millwood Drive West Bloomfield, MI 48322 www.fcica.com	248/661-5015 877/TO-FCICA
FM Global	Factory Mutual Insurance Company Mary Breighner Global Practice Leader Education, Public Entities, Health Care FM Global 9 Woodcrest Court Cincinnati, OH 45246 www.fmglobal.com	513/742-9516
FS	General Services Administration (GSA) Index of Federal Specifications, Standards and Commercial Item Descriptions 470 East L'Enfant Plaza, SW, Suite 8100 Washington, DC 20407 www.gsa.gov	202/619-8925
GA	The Gypsum Association 6525 Belcrest Road, Suite 480 Hyattsville, MD 20782 www.gypsum.org	301/277-8686

GANA	Glass Association of North America 800 SW Jackson St., Suite 1500 Topeka, KS 66612-1200 <a href="http://www.glasswebsite.com">www.glasswebsite.com</a>	785/271-0208
HMA	Hardwood Manufacturers Association 665 Rodi Road, Suite 305 Pittsburgh, PA 15235 <a href="http://hmamembers.org">http://hmamembers.org</a>	412/244-0440
HPVA	Hardwood Plywood & Veneer Association 1825 Michael Faraday Drive Reston, Virginia 20190 <a href="http://www.hpva.org">www.hpva.org</a>	703/435-2900
IAPMO	International Association of Plumbing and Mechanical Officials (formerly the Western Plumbing Officials Association) 4755 E. Philadelphia St. Ontario, CA 91761 <a href="http://www.iapmo.org">www.iapmo.org</a>	909/472-4100
ICC	International Code Council 500 New Jersey Avenue, NW, 6th Floor Washington, DC 20001 <a href="http://www.iccsafe.org">www.iccsafe.org</a>	888/422-7233
IEEE	Institute of Electrical and Electronics Engineers 3 Park Avenue, 17th Floor New York, NY 10016-5997 <a href="http://www.ieee.org">www.ieee.org</a>	212/419-7900
IES	Illuminating Engineering Society 120 Wall Street, Floor 17 New York, NY 10005-4001 <a href="http://www.ies.org">www.ies.org</a>	212/248-5000
ITRK	Intertek Testing Services 3933 US Route 11 Cortland, NY 13045 <a href="http://www.intertek.com">www.intertek.com</a>	607/753-6711



MCAA	Mechanical Contractors Association of America 1385 Piccard Drive Rockville, MD 20850 <a href="http://www.mcaa.org">www.mcaa.org</a>	301/869-5800
MIA	Marble Institute of America 28901 Clemens Rd, Ste 100 Cleveland, OH 44145 <a href="http://www.marble-institute.com">www.marble-institute.com</a>	440/250-9222
MMPA (formerly WMMPA)	Moulding & Millwork Producers Association (formerly Wood Moulding & Millwork Producers Association) 507 First Street Woodland, CA 95695 <a href="http://www.wmmpa.com">www.wmmpa.com</a>	530/661-9591 800/550-7889
MSS	Manufacturers Standardization Society (MSS) of the Valve and Fittings Industry 127 Park Street, NE Vienna, VA 22180-4602 <a href="http://mss-hq.org">http://mss-hq.org</a>	703/281-6613
NAAMM	National Association of Architectural Metal Manufacturers 800 Roosevelt Rd. Bldg. C, Suite 312 Glen Ellyn, IL 60137 <a href="http://www.naamm.org">www.naamm.org</a>	630/942-6591
NAIMA	North American Insulation Manufacturers Association 44 Canal Center Plaza, Suite 310 Alexandria, VA 22314 <a href="http://www.naima.org">www.naima.org</a>	703/684-0084
NAPA	National Asphalt Pavement Association 5100 Forbes Blvd. Lanham, MD USA 20706-4407 <a href="http://www.asphaltpavement.org">www.asphaltpavement.org</a>	888/468-6499 301/731-4748
NCSPA	National Corrugated Steel Pipe Association 14070 Proton Road, Suite 100 LB9 Dallas, TX 75244 <a href="http://www.ncspa.org">www.ncspa.org</a>	972/850-1907

NCMA	National Concrete Masonry Association 13750 Sunrise Valley Drive Herndon, VA 20171-4662 www.ncma.org	703/713-1900
NEBB	National Environmental Balancing Bureau 8575 Grovemont Circle Gaithersburg, MD 20877 www.nebb.org	301/977-3698
NECA	National Electrical Contractors Association 3 Bethesda Metro Center, Suite 1100 Bethesda, MD 20814 www.necanet.org	301/657-3110
	National Electrical Manufacturers Association 1300 North 17th Street, Suite 1752 Rosslyn, Virginia 22209 www.nema.org	703/841-3200
NEII	National Elevator Industry, Inc. 1677 County Route 64 P.O. Box 838 Salem, New York 12865-0838 www.neii.org	518/854-3100
NFPA	National Fire Protection Association 1 Batterymarch Park Quincy, Massachusetts USA 02169-7471 www.nfpa.org	617/770-3000
NHLA	National Hardwood Lumber Association PO Box 34518 Memphis, TN 38184 www.nhla.com	901/377-1818

NIA	National Insulation Association 12100 Sunset Hills Road, Suite 330 Reston, VA 20190 www.insulation.org	703/464-6422
NRCA	National Roofing Contractors Association 10255 W. Higgins Road, Suite 600 Rosemont, IL 60018-5607 www.nrca.net	847/299-9070
NSF	NSF International P.O. Box 130140 789 N. Dixboro Road Ann Arbor, MI 48113-0140, USA www.nsf.org	800/673-6275 734/769-8010
NTMA	National Terrazzo and Mosaic Association PO Box 2605 Fredericksburg, TX 78624 www.ntma.com	800/323-9736
OSHA	Occupational Safety and Health Act U.S. Department of Labor Occupational Safety & Health Administration 200 Constitution Ave., NW Washington, D.C. 20210 www.osha.gov	800/321-OSHA (6742)
PCA	Portland Cement Association 5420 Old Orchard Road Skokie, IL 60077 or 500 New Jersey Ave., N.W. 7 <sup>th</sup> Floor Washington, D.C. 20001 www.cement.org	847/966-6200 202/408-9494
PCI	Precast/Prestressed Concrete Institute 200 W. Adams St. #2100 Chicago, IL 60606 www.pci.org	312/786-0300
PDCA	Painting and Decorating Contractors of America 2316 Millpark Drive, Ste 220 Maryland Heights, MO 63043 www.pdca.com	800/332-PDCA (7322) 314/514-7322

PDI	Plumbing & Drainage Institute 800 Turnpike Street, Suite 300 North Andover, MA 01845 <a href="http://pdionline.org">http://pdionline.org</a>	978/557-0720 800/589-8956
PEI	Porcelain Enamel Institute, Inc. P.O. Box 920220 Norcross, GA 30010 <a href="http://www.porcelainenamel.com">www.porcelainenamel.com</a>	770/676-9366
PG&E	Pacific Gas & Electric Company <a href="http://www.pge.com">www.pge.com</a>	800/743-5000
PLANET	Professional Landcare Network 950 Herndon Parkway, Suite 450 Herndon, Virginia 20170 <a href="http://www.landcarenetwork.org">www.landcarenetwork.org</a>	703/736-9666 800/395-2522 703/736-9668
RFCI	Resilient Floor Covering Institute 115 Broad Street, Suite 201 La Grange GA 30240 <a href="http://www.rfci.com">www.rfci.com</a>	706/882-3833
RIS	Redwood Inspection Service 818 Grayson Road, Suite 201 Pleasant Hill, CA 94523 <a href="http://www.redwoodinspection.com">www.redwoodinspection.com</a>	925/935-1499
SDI	Steel Deck Institute P.O. Box 25 Fox River Grove, IL 60021 <a href="http://www.sdi.org">www.sdi.org</a>	847/458-4647
SDI	Steel Door Institute 30200 Detroit Road Westlake, Ohio 44145 <a href="http://www.steeldoor.org">www.steeldoor.org</a>	440/899-0010
SJI	Steel Joist Institute 234 W. Cheves Street Florence, SC 29501 <a href="http://steeljoist.org">http://steeljoist.org</a>	843/407-4091

SMA	Stucco Manufacturers Association 500 East Yale Loop Irvine, CA 92614 www.stuccomfgassoc.com	949/387.7611
SMACNA	Sheet Metal and Air Conditioning Contractors' National Association 4201 Lafayette Center Drive Chantilly, Virginia 20151-1219 www.smacna.org	703/803-2980
SPI	SPI: The Plastics Industry Trade Association, Inc. 1667 K St., NW, Suite 1000 Washington, DC 20006 www.plasticsindustry.org	202/974-5200
SSPC	Society for Protective Coatings (formerly the Steel Structures Painting Council) 40 24th St 6th Fl Pittsburgh, PA 15222 www.sspc.org	412/281-2331 877/281-7772
TCA	The Tile Council of North America 100 Clemson Research Blvd. Anderson, SC 29625 www.tcnatile.com	864/646-8453
TPI	Truss Plate Institute 218 North Lee Street, Suite 312 Alexandria, VA 22314 www.tpinst.org	703/683-1010
TPI	Turfgrass Producers International 2 East Main Street East Dundee, IL 60118 www.turfgrassod.org	800/405-8873 847/649-5555
TCIA	Tree Care Industry Association (formerly the National Arborist Association) 136 Harvey Road, Suite 101 Londonderry, NH 03053 www.tcia.org	800/733-2622

TVI	The Vermiculite Institute c/o The Schundler Company 150 Whitman Avenue Edison, NJ. 08817 <a href="http://www.vermiculiteinstitute.org">www.vermiculiteinstitute.org</a>	732/287-2244
UL	Underwriters Laboratories Inc. 333 Pfingsten Road Northbrook, IL 60062-2096 <a href="http://www.ul.com">www.ul.com</a>	847/272-8800 877/854-3577
UNI	Uni-Bell PVC Pipe Association 2711 LBJ Freeway, Suite 1000 Dallas, TX 75234 <a href="http://www.uni-bell.org">www.uni-bell.org</a>	972/243-3902
USDA	U.S. Department of Agriculture 1400 Independence Ave., S.W. Washington, DC 20250 <a href="http://www.usda.gov">www.usda.gov</a>	202/720-2791
WA	Wallcoverings Association 401 North Michigan Avenue Suite 2200 Chicago, IL 60611 <a href="http://www.wallcoverings.org">www.wallcoverings.org</a>	312/321-5166

WCLIB	West Coast Lumber Inspection Bureau P.O. Box 23145 Portland, OR 97281 or 6980 S.W. Varns Tigard, OR 97223 www.wclib.org	503/639-0651
WCMA	Window Covering Manufacturers Association 355 Lexington Avenue 15th Floor New York, New York 10017 www.wcmanet.org	212/297-2122
WDMA	Window & Door Manufacturers Association 401 N. Michigan Avenue, Suite 2200 Chicago, IL 60611 or 2025 M Street, NW, Ste. 800 Washington, D.C. 20036-3309 www.wdma.com	312/321-6802 202/367-1157
WI	Woodwork Institute P.O. Box 980247 West Sacramento, CA 95798 www.wicnet.org	916/372-9943
WRI	Wire Reinforcement Institute 942 Main Street Hartford, CT 06103 www.wirereinforcementinstitute.org	860/240-9545
WWCA	Western Wall & Ceiling Contractors Association 1910 N. Lime St. Orange, California 92865 www.wwcca.org	714/221-5520
WWPA	Western Wood Products Association 522 SW Fifth Ave., Suite 500 Portland, OR 97204-2122 www2.wwpa.org	503/224-3930

**PART 2 - PRODUCTS (Not Used)**

**PART 3 - EXECUTION (Not Used)**

END OF SECTION



## **MATERIALS AND EQUIPMENT**

### **PART 1 - GENERAL**

#### **1.01 RELATED DOCUMENTS AND PROVISIONS**

All Contract Documents should be reviewed for applicable provisions related to the provisions in this document, including without limitation the General Conditions and Agreements.

#### **1.02 MATERIAL AND EQUIPMENT**

- A. Only items approved by the Owner and/or Architect shall be used.
- B. Contractor shall submit lists of products and other product information in accordance with the Contract Documents, including, without limitation, the provisions regarding the submittals.

#### **1.03 MATERIAL AND EQUIPMENT COLORS**

- A. The Owner and/or Architect will provide a schedule of colors.
- B. No individual color selections will be made until after approval of all pertinent materials and equipment and after receipt of appropriate samples in accordance with the Contract Documents, including, without limitation, the provisions regarding the submittals.
- C. Contractor shall request priority in writing for any item requiring advance ordering to maintain the approved Construction Schedule.

#### **1.04 DELIVERY, STORAGE, AND HANDLING**

- A. Contractor shall deliver manufactured materials in original packages, containers, or bundles (with seals unbroken), bearing name or identification mark of manufacturer.
- B. Contractor shall deliver fabrications in as large assemblies as practicable; where specified as shop-primed or shop-finished, package or crate as required to preserve such priming or finish intact and free from abrasion.
- C. Contractor shall store materials in such a manner as necessary to properly protect them from damage. Materials or equipment damaged by handling, weather, dirt, or from any other cause will not be accepted.

- D. Materials are not acceptable that have been warehoused for long periods of time, stored or transported in improper environment, improperly packaged, inadequately labeled, poorly protected, excessively shipped, deviated from normal distribution pattern, or reassembled.
- E. Contractor shall store material so as to cause no obstructions of sidewalks, roadways, and underground services. Contractor shall protect material and equipment furnished under Contract.
- F. Contractor may store materials on Site with prior written approval by the Owner, all material shall remain under Contractor's control and Contractor shall remain liable for any damage to the materials. Should the Project Site not have storage area available, the Contractor shall provide for off-site storage at a bonded warehouse and with appropriate insurance coverage at no cost to Owner.
- G. When any room in Project is used as a shop or storeroom, the Contractor shall be responsible for any repairs, patching, or cleaning necessary due to that use. Location of storage space shall be subject to prior written approval by Owner.

## **PART 2 - PRODUCTS**

### **2.01 MANUFACTURERS**

- A. Manufacturers listed in various sections of Contract Documents are names of those manufacturers that are believed to be capable of supplying one or more of items specified therein.
- B. The listing of a manufacturer does not imply that every product of that manufacturer is acceptable as meeting the requirements of the Contract Documents.

### **2.02 FACILITIES AND EQUIPMENT**

Contractor shall provide, install, maintain, and operate a complete and adequate facility for handling, the execution, disposal, and distribution of material and equipment as required for proper and timely performance of Work connected with Contract.

### **2.03 MATERIAL REFERENCE STANDARDS**

Where material is specified solely by reference to “standard specifications” and if requested by Owner, Contractor shall submit for review data on actual material proposed to be incorporated into Work of Contract listing name and address of vendor, manufacturer, or producer, and trade or brand names of those materials, and data substantiating compliance with standard specifications.

## **PART 3 - EXECUTION**

### **3.01 WORKMANSHIP**

- A. Where not more specifically described in any other Contract Documents, workmanship shall conform to methods and operations of best standards and accepted practices of trade or trades involved and shall include items of fabrication, construction, or installation regularly furnished or required for completion (including finish and for successful operation, as intended).
- B. Work shall be executed by tradespersons skilled in their respective lines of Work. When completed, parts shall have been durably and substantially built and present a neat appearance.

### **3.02 COORDINATION**

- A. Contractor shall coordinate installation of Work so as to not interfere with installation of others. Adjustment or rework because of Contractor's failure to coordinate will be at no additional cost to Owner.
- B. Contractor shall examine in-place work for readiness, completeness, fitness to be concealed or to receive other work, and in compliance with Contract Documents. Concealing or covering Work constitutes acceptance of additional cost which will result should in-place Work be found unsuitable for receiving other Work or otherwise deviating from the requirements of the Contract Documents.

### **3.03 COMPLETENESS**

Contractor shall provide all portions of the Work, unless clearly stated otherwise, installed complete and operational with all elements, accessories, anchorages, utility connections, etc., in manner to assure well-balanced performance, in accordance with manufacturer's recommendations and by Contract Documents. For example, electric water coolers require water, electricity, and drain services; roof drains require drain system; sinks fit within countertop, etc. Terms such as "installed complete," "operable condition," "for use intended," "connected to all utilities," "terminate with proper cap," "adequately anchored," "patch and refinish," "to match similar," should be assumed to apply in all cases, except where completeness of functional or operable condition is specifically stated as not required.

### **3.04 APPROVED INSTALLER OR APPLICATOR**

Installation by a manufacturer's approved installer or applicator is an understood part of Specifications and only approved installer or applicator is to provide on-site Work where specified manufacturer has on-going program of approving (i.e. certifying, bonding, re-warranting) installers or applicators. Newly established relationships between a manufacturer and an installer or applicator who does not have other approved applicator work in progress or completed is not approved for this Project.

### **3.05 MANUFACTURER'S RECOMMENDATIONS**

All installations shall be in accordance with manufacturer's published recommendations and specific written directions of manufacturer's representative. Should Contract Documents differ from recommendations of manufacturer or directions of his representative, Contractor shall analyze differences, make recommendations to the Owner and the Architect in writing, and shall not proceed until interpretation or clarification has been issued by the Owner and/or the Architect.

END OF SECTION

## QUALITY CONTROL

### PART 1 - GENERAL

#### 1.01 RELATED DOCUMENTS AND PROVISIONS:

All Contract Documents should be reviewed for applicable provisions related to the provisions in this document, including without limitation:

- A. General Conditions, including, without limitation, Inspector of Record, Tests and Inspections, Uncovering and Correction of Work; and
- B. Agreement.

#### 1.02 RELATED CODES:

- A. The Work is governed by requirements of Title 24, California Code of Regulations (“CCR”), and the Contractor shall keep a copy of these available at the job Site for ready reference during construction.
- B. The Division of the State Architect (“DSA”) shall be notified at or before the start of construction.

#### 1.03 APPLICABLE CODES:

- A. Work of the project shall conform to the following Codes, copies of which shall be maintained at the job site by the Contractor throughout the duration of the work:

- 1.3.1 2013 California Building Standards Administrative Code (Part 1, Title 24, CCR)
- 1.3.2 2013 California Building Code (Part 2, Title 24, CCR)  
(2015 Edition International Building Code of the International Code Council with California Amendments)
- 1.3.3 2013 California Electrical Code (Part 3, Title 24, CCR)  
(2014 Edition National Electrical Code of the National Fire Protection Association, NFPA)
- 1.3.4 2013 California Mechanical Code (Part 4, Title 24 CCR)  
(2015 Edition Uniform Mechanical Code of the International Association of Plumbing and Mechanical Officials, IAPMO)
- 1.3.5 2010 California Plumbing Code (Part 5, Title 24, CCR)

(2015 Edition Uniform Plumbing Code of the International Association of Plumbing and Mechanical Officials, IAPMO)

- 1.3.6 2013 California Energy Code (Part 6, Title 24, CCR)
- 1.3.7 California Elevator Safety Orders (Subchapter 6, Chapter 4, Division 1, Title 8, CCR)
- 1.3.8 2013 California Historical Building Code (Part 8, Title 24, CCR)
- 1.3.9 2013 California Fire Code (Part 9, Title 24, CCR)
- 1.3.10 2013 California Existing Building Code (Part 10, Title 24, CCR)
- 1.3.11 2013 California Referenced Standards Code (Part 12, Title 24 CCR)
- 1.3.12 NFPA 13, 2016 Edition, Automatic Sprinkler Systems, California Amended
- 1.3.13 NFPA 17 Dry Chemical Extinguishing Systems 2013 Edition
- 1.3.14 NFPA 24, 2016 Edition, Private Fire Service Mains
- 1.3.15 NFPA 72, 2016 Edition, National Fire Alarm Code California Amended (Note: See UL Standard 1971 for “Visual Devices”)
- 1.3.16 NFPA 253 Critical Radiant Flux of Floor Covering Systems (2015 Edition)
- 1.3.17 NFPA 2015 Clean Agent Fire Extinguishing Systems current Edition

#### **1.04 OBSERVATION AND SUPERVISION:**

- A. The Owner and Architect or their appointed representatives will review the Work and the Contractor shall provide facilities and access to the Work at all times as required to facilitate this review. Administration by the Architect and any consulting Structural Engineer will be in accordance with applicable regulations, including, without limitation, CCR, Part 1, Title 24, Section 4-341.
- B. One or more Project Inspector(s) approved by DSA and employed by or in contract with the Owner, referred to hereinafter as the “Project Inspector,” will observe the work in accordance with CCR, Part 1, Title 24, Sections 4-333(b) and 4-342:

- (1) The Project Inspector shall have access to the Work wherever it is in preparation or progress for ascertaining that the Work is in accordance with the Contract Documents and all applicable code sections. The Contractor shall provide facilities and access as required and shall provide assistance for sampling or measuring materials.
- (2) The Project Inspector will notify the Owner and Architect and call the attention of the Contractor to any observed failure of Work or material to conform to Contract Documents.
- (3) The Project Inspector shall observe and monitor all testing and inspection activities required.

The Contractor shall conform with all applicable laws as indicated in the Contract Documents, including, without limitation, to CCR, Part 1, Title 24, Section 4-343. The Contractor shall supervise and direct the Work and maintain a competent superintendent on the job who is authorized to act in all matters pertaining to the Work. The Contractor's superintendent shall also inspect all materials, as they arrive, for compliance with the Contract Documents. Contractor shall reject defective Work or materials immediately upon delivery or failure of the Work or material to comply with the Contract Documents. The Contractor shall submit verified reports as indicated in the Contract Documents, including, without limitation, the Specifications and as required by Part 1, Title 24, Section 4-336.

#### **1.05 TESTING AGENCIES:**

- A. Testing agencies and tests shall be in conformance with the Contract Documents and the requirements of Part 1, Title 24, Section 4-335.
- B. Testing and inspection in connection with earthwork shall be under the direction of the Owner's consulting soils engineer, if any, referred to hereinafter as the "Soils Engineer."
- C. Testing and inspection of construction materials and workmanship shall be performed by a qualified laboratory, referred to hereinafter as the "Testing Laboratory." The Testing Laboratory shall be under direction of an engineer registered in the State of California, shall conform to requirements of ASTM E329, and shall be employed by or in contract with the Owner.

#### **1.06 TESTS AND INSPECTIONS:**

- A. The Contractor shall be responsible for notifying the Owner and Project Inspector of all required tests and inspections. Contractor shall notify the Owner and Project Inspector at least seventy-two hours (72) hours in advance of performing any Work requiring testing or inspection.
- B. The Contractor shall provide access to Work to be tested and furnish incidental labor, equipment, and facilities to facilitate all inspections and tests.

- C. The Owner will pay for first inspections and tests required by the “CCR,” and other inspections or tests that the Owner and/or the Architect may direct to have made, including the following principal items:
- (1) Tests and observations for earthwork and paving.
  - (2) Tests for concrete mix designs, including tests of trial batches.
  - (3) Tests and inspections for structural steel work.
  - (4) Field tests for framing lumber moisture content.
  - (5) Additional tests directed by the Owner that establish that materials and installation comply with the Contract Documents.
  - (6) Test and observation of welding and expansion anchors.
- D. The Owner may at its discretion, pay and back charge the Contractor for:
- (1) Retests or reinspections, if required, and tests or inspections required due to Contractor error or lack of required identifications of material.
  - (2) Uncovering of work in accordance with Contract Documents.
  - (3) Testing done on weekends, holidays, and overtime will be chargeable to the Contractor for the overtime portion.
  - (4) Testing done off Site.
- E. Testing and inspection reports and certifications:
- (1) If initially received by Contractor, Contractor shall provide to each of the following a copy of the agency or laboratory report of each test or inspection or certification.
    - (a) The Owner;
    - (b) The Construction Manager, if any;
    - (c) The Architect;
    - (d) The Consulting Engineer, if any;
    - (e) Other engineers on the Project, as appropriate;
    - (f) The Project Inspector; and
    - (g) The Contractor.



- (2) When the test or inspection is one required by the CCR, a copy of the report shall also be provided to the DSA.

**PART 2 - PRODUCTS**

**2.01 TYPE OF TEST AND INSPECTIONS:**

**[FILL IN OR MODIFIED AS APPROPRIATE AFTER CONSULTATION WITH ARCHITECT]**

A.

B.

C.

**PART 3 - EXECUTION (Not Used)**

END OF SECTION

## **TEMPORARY FACILITIES AND CONTROLS**

### **PART 1 – GENERAL**

#### **1.01 RELATED DOCUMENTS AND PROVISIONS:**

All Contract Documents should be reviewed for applicable provisions related to the provisions in this document, including without limitation:

- A. General Conditions; and
- B. Agreement.

#### **1.02 TEMPORARY UTILITIES:**

##### **A. Electric Power and Lighting**

- (1) Contractor will pay for power during the course of the Work. To the extent power is available in the building(s) or on the Site, Contractor may use the Owner's existing utilities by making prearranged payments to the Owner for the utilities used by Contractor and all Subcontractors. Contractor shall be responsible for providing temporary facilities required to deliver that power service from its existing location in the building(s) or on the Site to point of intended use.
- (2) Contractor shall verify characteristics of power available in building(s) or on the Site. Contractor shall take all actions required to make modifications where power of higher voltage or different phases of current are required. Contractor shall be fully responsible for providing that service and shall pay all costs required therefor.
- (3) Contractor shall furnish, wire for, install, and maintain temporary electrical lights wherever it is necessary to provide illumination for the proper performance and/or observation of the Work: a minimum of 20 foot-candles for rough work and 50 foot-candles for finish work.
- (4) Contractor shall be responsible for maintaining existing lighting levels in the project vicinity should temporary outages or service interruptions occur.

##### **B. Heat and Ventilation**

- (1) Contractor shall provide temporary heat to maintain environmental conditions to facilitate progress of the Work, to meet specified minimum conditions for the installation and curing of materials, and to protect materials and finishes from damage due to improper temperature and humidity conditions. Portable heaters shall be standard units complete with controls.

- (2) Contractor shall provide forced ventilation and dehumidification, as required, of enclosed areas for proper installation and curing of materials, to disperse humidity, and to prevent hazardous accumulations of dust, fumes, vapors, and gases.
- (3) Contractor shall pay the costs of installation, maintenance, operation, and removal of temporary heat and ventilation, including costs for fuel consumed, required for the performance of the Work.

C. Water

- (1) Contractor will pay for water during the course of the Work. To the extent water is then available in the building(s) or on the Site, Contractor may use the Owner's existing utilities by making prearranged payments to the Owner for the utilities used by Contractor and all Subcontractors. Contractor shall be responsible for providing temporary facilities required to deliver such utility service from its existing location in the building(s) or on the Site to point of intended use.
- (2) Contractor shall use backflow preventers on water lines at point of connection to Owner's water supply. Backflow preventers shall comply with requirements of Uniform Plumbing Code.
- (3) Contractor shall make potable water available for human consumption.

D. Sanitary Facilities

- (1) Contractor shall provide sanitary temporary facilities in no fewer numbers than required by law and such additional facilities as may be directed by the Inspector for the use of all workers. The facilities shall be maintained in a sanitary condition at all times and shall be left at the Site until removal is directed by the Inspector or Contractor completes all other work at the Site.
- (2) Use of toilet facilities in the Work under construction shall not be permitted except by consent of the Inspector and the Owner.

E. Telephone Service

- (1) Contractor shall arrange with local telephone service company for telephone service for the performance of the Work. Contractor shall, at a minimum, provide in its field office one line for telephone and one line for fax machine.
- (2) Contractor shall pay the costs for telephone and fax lines installation, maintenance, service, and removal.

F. Fire Protection:

- (1) Contractor shall provide and maintain fire extinguishers and other equipment for fire protection. Such equipment shall be designated for use for fire protection only and shall comply with all requirements of the California Fire, State Fire Marshall and/or its designee.
- (2) Where on-site welding and burning of steel is unavoidable, Contractor shall provide protection for adjacent surfaces.

G. Trash Removal:

- (1) Contractor shall provide trash removal on a timely basis. **[OWNER MAY INDICATE SPECIFIC FREQUENCY FOR PROJECT]**

H. Temporary Facilities:

- (1) **[FILL IN AS APPROPRIATE]**

**1.03 CONSTRUCTION AIDS:**

A. Plant and Equipment:

- (1) Contractor shall furnish, operate, and maintain a complete plant for fabricating, handling, conveying, installing, and erecting materials and equipment; and for conveyances for transporting workmen. Include elevators, hoists, debris chutes, and other equipment, tools, and appliances necessary for performance of the Work.
- (2) Contractor shall maintain plant and equipment in safe and efficient operating condition. Damages due to defective plant and equipment, and uses made thereof, shall be repaired by Contractor at no expense to the Owner.

B. None of the Owner's tools and equipment shall be used by Contractor for the performance of the Work.

**1.04 BARRIERS AND ENCLOSURES:**

- A. Contractor shall obtain the Owner's written permission for locations and types of temporary barriers and enclosures, including fire-rated materials proposed for use, prior to their installation.
- B. Contractor shall provide and maintain temporary enclosures to prevent public entry and to protect persons using other buildings and portions of the Site and/or Premises, the public, and workers. Contractor shall also protect the Work and existing facilities from the elements, and adjacent construction and improvements, persons, and trees and plants from damage and injury from demolition and construction operations.

- C. Contractor shall provide site access to existing facilities for persons using other buildings and portions of the Site, the public, and for deliveries and other services and activities.
- D. Tree and Plant Protection:
- (1) Contractor shall preserve and protect existing trees and plants on the Premises that are not designated or required to be removed, and those adjacent to the Premises.
  - (2) Contractor shall provide barriers to a minimum height of 4'-0" around drip line of each tree and plant, around each group of trees and plants, as applicable, in the proximity of demolition and construction operations.
  - (3) Contractor shall not park trucks, store materials, perform Work or cross over landscaped areas. Contractor shall not dispose of paint thinners, water from cleaning, plastering or concrete operations, or other deleterious materials in landscaped areas, storm drain systems, or sewers. Plant materials damaged as a result of the performance of the Work shall, at the option of the Owner and at Contractor's expense, either be replaced with new plant materials equal in size to those damaged or by payment of an amount representing the value of the damaged materials as determined by the Owner.
  - (4) Contractor shall remove soil that has been contaminated during the performance of the Work by oil, solvents, and other materials which could be harmful to trees and plants, and replace with good soil, at Contractor's expense.
  - (5) Excavation around Trees:
    - (a) Excavation within drip lines of trees shall be done only where absolutely necessary and with written permission from the Owner.
    - (b) Where trenching for utilities is required within drip lines, tunneling under and around roots shall be by hand digging and shall be approved by the Owner. Main lateral roots and taproots shall not be cut. All roots 2 inches in diameter and larger shall be tunneled under and heavily wrapped with wet burlap so as to prevent scarring or excessive drying. Smaller roots that interfere with installation of new work may be cut with prior approval by the Owner. Roots must first be cut with a Vermeer, or equivalent, root cutter prior to any trenching.
    - (c) Where excavation for new construction is required within drip line of trees, hand excavation shall be employed to minimize damage to root system. Roots shall be relocated in backfill areas wherever possible. If encountered immediately adjacent to location of new construction, roots shall be cut approximately 6 inches back from new construction.

- (d) Approved excavations shall be carefully backfilled with the excavated materials approved for backfilling. Backfill shall conform to adjacent grades without dips, sunken areas, humps, or other surface irregularities. Do not use mechanical equipment to compact backfill. Tamp carefully using hand tools, refilling and tamping until Final Acceptance as necessary to offset settlement.
- (e) Exposed roots shall not be allowed to dry out before permanent backfill is placed. Temporary earth cover shall be provided, or roots shall be wrapped with four layers of wet, untreated burlap and temporarily supported and protected from damage until permanently relocated and covered with backfill.
- (f) Accidentally broken roots should be sawed cleanly 3 inches behind ragged end.

#### **1.05 SECURITY:**

The Contractor shall be responsible for project security for materials, tools, equipment, supplies, and completed and partially completed Work.

#### **1.06 TEMPORARY CONTROLS:**

##### **A. Noise Control**

- (1) Contractor acknowledges that adjacent facilities may remain in operation during all or a portion of the Work period, and it shall take all reasonable precautions to minimize noise as required by applicable laws and the Contract Documents.
- (2) Notice of proposed noisy operations, including without limitation, operation of pneumatic demolition tools, concrete saws, and other equipment, shall be submitted to the Owner a minimum of forty-eight (48) hours in advance of their performance.

##### **B. Noise and Vibration**

- (1) Equipment and impact tools shall have intake and exhaust mufflers.
- (2) Contractor shall cooperate with Owner to minimize and/or cease the use of noisy and vibratory equipment if that equipment becomes objectionable by its longevity.

##### **C. Dust and Dirt**

- (1) Contractor shall conduct demolition and construction operations to minimize the generation of dust and dirt, and prevent dust and dirt from interfering with the progress of the Work and from accumulating in the Work and adjacent areas including, without limitation, occupied facilities.

- (2) Contractor shall periodically water exterior demolition and construction areas to minimize the generation of dust and dirt.
- (3) Contractor shall ensure that all hauling equipment and trucks carrying loads of soil and debris shall have their loads sprayed with water or covered with tarpaulins, and as otherwise required by local and state ordinance.
- (4) Contractor shall prevent dust and dirt from accumulating on walks, roadways, parking areas, and planting, and from washing into sewer and storm drain lines.

D. Water

Contractor shall not permit surface and subsurface water, and other liquids, to accumulate in or about the vicinity of the Premises. Should accumulation develop, Contractor shall control the water or other liquid, and suitably dispose of it by means of temporary pumps, piping, drainage lines, troughs, ditches, dams, or other methods.

E. Pollution

- (1) No burning of refuse, debris, or other materials shall be permitted on or in the vicinity of the Premises.
- (2) Contractor shall comply with applicable regulatory requirements and anti-pollution ordinances during the conduct of the Work including, without limitation, demolition, construction, and disposal operations.

F. Lighting

- (1) If portable lights are used after dark, all light must be located so as not to direct light into neighboring property.

**1.07 JOB SIGN(S):**

A. General:

- (1) Contractor shall provide and maintain a Project identification sign with the design, text, and colors designated by the Owner and/or the Architect; locate sign as approved by the Owner.
- (2) Signs other than the specified Project sign and or signs required by law, for safety, or for egress, shall not be permitted, unless otherwise approved in advance by the Owner.

B. Materials:

- (1) Structure and Framing: Structurally sound, new or used wood or metal; wood shall be nominal 3/4-inch exterior grade plywood.
- (2) Sign Surface: Minimum 3/4-inch exterior grade plywood.

- (3) Rough Hardware: Galvanized.
- (4) Paint: Exterior quality, of type and colors selected by the Owner and/or the Architect.

C. Fabrication:

- (1) Contractor shall fabricate to provide smooth, even surface for painting.
- (2) Size: 4'-0" x 8'-0", unless otherwise indicated.
- (3) Contractor shall paint exposed surfaces of supports, framing, and surface material with exterior grade paint: one coat of primer and one coat of finish paint.
- (4) Text and Graphics: As indicated.

**1.08 PUBLICITY RELEASES:**

- A. Contractor shall not release any information, story, photograph, plan, or drawing relating information about the Project to anyone, including press and other public communications medium, including, without limitation, on website(s).

**PART 2 – PRODUCTS (Not Used)**

**PART 3 – EXECUTION (Not Used)**

END OF DOCUMENT



## **CONSTRUCTION WASTE MANAGEMENT AND DISPOSAL**

### **PART 1 - GENERAL**

#### **1.01 RELATED DOCUMENTS AND PROVISIONS:**

All Contract Documents should be reviewed for applicable provisions related to the provisions in this document, including without limitation:

- A. General Conditions;
- B. Agreement; and
- C. Document 01 50 00.

#### **1.02 SECTION INCLUDES:**

- A. Administrative and procedural requirements for the following:
  - (1) Salvaging non-hazardous construction waste.
  - (2) Recycling non-hazardous construction waste.
  - (3) Disposing of non-hazardous construction waste.

#### **1.03 DEFINITIONS:**

- A. Construction Waste: Building and site improvement materials and other solid waste resulting from construction, remodeling, renovation, or repair operations. Construction waste includes packaging.
- B. Demolition Waste: Building and site improvement materials resulting from demolition or selective demolition operations.
- C. Disposal: Removal off-site of demolition and construction waste and subsequent sale, recycling, reuse, or deposit in landfill or incinerator acceptable to authorities having jurisdiction.
- D. Recycle: Recovery of demolition or construction waste for subsequent processing in preparation for reuse.
- E. Salvage: Recovery of demolition or construction waste and subsequent sale or reuse in another facility.
- F. Salvage and Reuse: Recovery of demolition or construction waste and subsequent incorporation into the Work.

- G. Chemical Waste: Includes petroleum products, bituminous materials, salts, acids, alkalis, herbicides, pesticides, organic chemicals and inorganic wastes.
- H. Sanitary Waste:
  - (1) Garbage: Refuse and scraps resulting from preparation, cooking, distribution, or consumption of food.
  - (2) Sewage: Domestic sanitary sewage.

#### **1.04 PERFORMANCE REQUIREMENTS:**

- A. General: Develop waste management plan that results in end-of Project rates for salvage/recycling of fifty percent (50%) by weight (or by volume, but not a combination) of total waste generated by the Work.

#### **1.05 SUBMITTALS:**

- A. Waste Management Plan: Submit waste management plan within 5 days of date established for commencement of the Work.
- B. Waste Reduction Progress Reports: Concurrent with each Application for Payment, submit copies of report. Include the following information:
  - (1) Material category.
  - (2) Generation point of waste.
  - (3) Total quantity of waste in tons or cubic yards.
  - (4) Quantity of waste salvaged, both estimated and actual in tons or cubic yards.
  - (5) Quantity of waste recycled, both estimated and actual in tons or cubic yards.
  - (6) Total quantity of waste recovered (salvaged plus recycled) in tons or cubic yards.
  - (7) Total quantity of waste recovered (salvaged plus recycled) as a percentage of total waste.
- C. Submit permit or license and location of recycling or waste disposal sites. Waste Reduction Calculations: Before final payment, submit copies of calculated end-of-Project rates for salvage, recycling, and disposal as a percentage of total waste generated by the Work.
- D. Records of Donations: Indicate receipt and acceptance of salvageable waste donated to individuals and organizations. Indicate whether organization is tax exempt.

- E. Records of Sales: Indicate receipt and acceptance of salvageable waste sold to individuals and organizations. Indicate whether organization is tax exempt.
- F. Recycling and Processing Facility Records: Indicate receipt and acceptance of recyclable waste by recycling and processing facilities licensed to accept them. Include manifests, weight tickets, receipts, and invoices.
- G. Landfill and Incinerator Disposal Records: Indicate receipt and acceptance of waste by landfills and incinerator facilities licensed to accept them. Include manifests, weight tickets, receipts, and invoices.
- H. CHPS Submittal: CHPS letter template for Credit ME2.0 and ME2.1, signed by Contractor, tabulating total waste material, quantities diverted and means by which it is diverted, and statement that requirements for the credit have been met.
- I. Qualification Data: For Waste Management Coordinator.
- J. Statement of Refrigerant Recovery: Signed by refrigerant recovery technician responsible for recovering refrigerant, stating that all refrigerant that was present was recovered and that recovery was performed according to EPA regulations. Include name and address of technician and date refrigerant was recovered.
- K. Submittal procedures and quantities are specified in Document 01 33 00.

**1.06 QUALITY ASSURANCE:**

- A. Waste Management Coordinator Qualifications: LEED Accredited Professional by U.S. Green Building Council.
- B. Regulatory Requirements: Comply with hauling and disposal regulations of authorities having jurisdiction.
- C. Waste Management Conference: Conduct conference at Project site to comply with requirements. Review methods and procedures related to waste management including, but not limited to, the following:
  - (1) Review and discuss waste management plan including responsibilities of Waste Management Coordinator.
  - (2) Review requirements for documenting quantities of each type of waste and its disposition.
  - (3) Review and finalize procedures for materials separation and verify availability of containers and bins needed to avoid delays.
  - (4) Review procedures for periodic waste collection and transportation to recycling and disposal facilities.

- (5) Review waste management requirements for each trade.

#### **1.07 WASTE MANAGEMENT PLAN:**

- A. General: Develop plan consisting of waste identification, waste reduction work plan, and cost/revenue analysis. Indicate quantities by weight or volume, but use same units of measure throughout waste management plan.
- B. Waste Identification: Indicate anticipated types and quantities of site-clearing and construction waste generated by the Work. Include estimated quantities and assumptions for estimates.
- C. Waste Reduction Work Plan: List each type of waste and whether it will be salvaged, recycled, or disposed of in landfill or incinerator. Include points of waste generation, total quantity of each type of waste, quantity for each means of recovery, and handling and transportation procedures.
  - (1) Salvaged Materials for Reuse: For materials that will be salvaged and reused in this Project, describe methods for preparing salvaged materials before incorporation into the Work.
  - (2) Salvaged Materials for Sale: For materials that will be sold to individuals and organizations, include list of their names, addresses, and telephone numbers.
  - (3) Salvaged Materials for Donation: For materials that will be donated to individuals and organizations, include list of their names, addresses, and telephone numbers.
  - (4) Recycled Materials: Include list of local receivers and processors and type of recycled materials each will accept. Include names, addresses, and telephone numbers.
  - (5) Disposed Materials: Indicate how and where materials will be disposed of. Include name, address, and telephone number of each landfill and incinerator facility.
  - (6) Handling and Transportation Procedures: Include method that will be used for separating recyclable waste including sizes of containers, container labeling, and designated location on Project site where materials separation will be located.

## **PART 2 - PRODUCTS (Not Used)**

## **PART 3 - EXECUTION**

### **3.01 PLAN IMPLEMENTATION:**

- A. General: Implement approved waste management plan. Provide handling, containers, storage, signage, transportation, and other items as required to implement waste management plan during the entire duration of the Contract.
  
- B. Comply with Document 01 50 00 for operation, termination, and removal requirements. Equipment Salvage: Any existing equipment that can be salvage for resale, reuse, or salvaged for parts shall be removed in a manner preserving the equipment integrity. Removed equipment shall be palletized all the operational parts included, wrap in plastic shrink-wrap, and return as directed by the Owner. The Owner may also require any equipment be sent to a designated reseller. The following equipment maybe salvaged including but not limited to the following:
  - (1) Light fixtures (without fluorescent Light bulbs)
  - (2) Electrical equipment (deemed PCB free)
  - (3) Electronic Equipment / IDF cabinets or racks
  - (4) Ventilation hoods
  - (5) Refrigerators or Freezers (including Walk-ins)
  - (6) Mechanical Units
  - (7) Mechanical Compressors
  - (8) Plumbing fixtures
  - (9) Toilet room accessories
  - (10) Windows, Doors and Frames
  - (11) Casework
  - (12) White Boards and framed Pin Boards
  - (13) Pencil sharpeners / Projections Screens
  - (14) Masonry or bricks
  - (15) Others as appropriate.

- C. Waste Management Coordinator: Engage a waste management coordinator to be responsible for implementing, monitoring, and reporting status of waste management work plan. Coordinator shall be present at Project site full time for duration of Project.
- D. Training: Train workers, subcontractors, and suppliers on proper waste management procedures, as appropriate for the Work occurring at Project site.
  - (1) Distribute waste management plan to everyone concerned within 3 days of submittal return.
  - (2) Distribute waste management plan to entities when they first begin work on site. Review plan procedures and locations established for salvage, recycling, and disposal.
- E. Site Access and Temporary Controls: Conduct waste management operations to ensure minimum interference with roads, streets, walks, walkways, and other adjacent occupied and used facilities.
  - (1) Designate and label specific areas of Project site necessary for separating materials that are to be salvaged, recycled, reused, donated, and sold.
  - (2) Comply with Document 01 50 00 for controlling dust and dirt, environmental protection, and noise control.

**3.02 RECYCLING CONSTRUCTION WASTE:**

- A. General: Recycle paper and beverage containers used by on-site workers.
- B. Recycling Incentives: Revenues, savings, rebates, tax credits, and other incentives received for recycling waste materials shall accrue to the Contractor.
- C. Procedures: Separate recyclable waste from other waste materials, trash, and debris. Separate recyclable waste by type at Project site to the maximum extent practical.
  - (1) Provide appropriately marked containers or bins for controlling recyclable waste until they are removed from Project Site. Include list of acceptable and unacceptable materials at each container and bin.
    - (a) Inspect containers and bins for contamination and remove contaminated materials if found.
  - (2) Stockpile processed materials on site without intermixing with other materials. Place, grade, and shape stockpiles to drain surface water. Cover to prevent windblown dust.

- (3) Stockpile materials away from construction area. Do not store within drip line of remaining trees.
  - (4) Store components off the ground and protect from the weather.
  - (5) Remove recyclable waste off Owner property and transport to recycling receiver or processor.
- D. Packaging:
- (1) Cardboard and Boxes: Break down packaging into flat sheets. Bundle and store in a dry location.
  - (2) Polystyrene Packaging: Separate and bag material.
  - (3) Pallets: As much as possible, require deliveries using pallets to remove pallets from Project Site. For pallets that remain on Site, break down pallets into component wood pieces and comply with requirements for recycling wood.
  - (4) Crates: Break down crates into component wood pieces and comply with requirements for recycling wood.
- E. Site-Clearing Wastes: Chip brush, branches, and trees on site.
- F. Wood Materials:
- (1) Clean Cut-Offs of Lumber: Grind or chip into small pieces.
  - (2) Clean Sawdust: Bag sawdust that does not contain painted or treated wood.
- G. Gypsum Board: Stack large clean pieces on wood pallets and store in a dry location.
- (1) Clean Gypsum Board: Grind scraps of clean gypsum board using small mobile chipper or hammer mill. Screen out paper after grinding.

### **3.03 DISPOSAL OF WASTE:**

- A. General: Except for items or materials to be salvaged, recycled, or otherwise reused, remove waste materials from Project Site and legally dispose of them in a landfill or incinerator acceptable to authorities having jurisdiction.
- (1) Except as otherwise specified, do not allow waste materials that are to be disposed of accumulate on site.
  - (2) Remove and transport debris in a manner that will prevent spillage on adjacent surfaces and areas.

- B. Burning: Do not burn waste materials.
- C. Disposal: Transport waste materials off Owner property and legally dispose of them.

END OF SECTION



## **FIELD OFFICES**

### **PART 1 – GENERAL**

#### **1.01 RELATED DOCUMENTS AND PROVISIONS:**

All Contract Documents should be reviewed for applicable provisions related to the provisions in this document, including without limitation:

- A. General Conditions; and
- B. Agreement.

#### **1.02 SECTION INCLUDES:**

- A. Requirements for Field Offices and Field Office Trailers.

#### **1.03 SUMMARY:**

- A. General: Contractor shall provide Owner's Field Office Trailer and contents, for Owner's use exclusively, during the term of the Contract. Contractor shall provide a space to work and desk for the Project Inspector.
- B. Property: Trailer, furniture, furnishings, equipment, and the like, supplied by the Contractor with the Office Trailer shall remain the property of the Contractor; Owner property items installed, delivered, and the like by Owner within the Office Trailer will remain Owner's property.
- C. Modifications: Owner reserves the right to modify the trailer or contents, or both, as may be deemed proper by Owner.
- D. Condition: Trailer and contents shall be clean, neat, substantially finished, in good, proper, and safe condition for use, operation, and the like; the trailer and contents shall not be required to be new.
- E. Installation Timing: Provide safe, fully furnished, functional, proper, complete, and finished trailer properly ready for entire use, within ten (10) calendar days of Owner's notification of the issuance of Notice to Proceed.

#### **1.04 SUBMITTALS:**

- A. General: Submit submittals to Owner in quantity, format, type, and the like, as specified herein.
- B. Office Trailer Data: One (1) copy of manufacturer's descriptive data, technical descriptions, regulatory compliance, industry standards, installation, removal, and maintenance instructions.

- C. Equipment Data: Two (2) copies of manufacturer data for each type of equipment, if directed by Owner.
- D. Furniture and Furnishings Data: Two (2) copies of manufacturer data for each type of equipment, if directed by Owner.
- E. Plans: One (1) electronic file, One (1) reproducible copy of appropriately scaled plans of trailer layout. Plans shall include, but not be limited to: lighting; furniture; equipment; telephone and electrical outlets; and the like. At the Owners discretion, the file may be required to be uploaded to e-Builder.
- F. Product Samples: One (1) complete and entire unit of each type, if directed by Owner.

## **1.05 QUALITY ASSURANCE**

- A. Standards: In the event that provisions of codes, regulations, safety orders, Contract Documents, referenced manufacturer’s specifications, manufacturer’s instructions, industry standards, and the like, are in conflict, the more restrictive and higher quality shall govern.
- B. Installer: Installer or Installers engaged by Contractor must have a minimum of five (5) years of documented and properly authenticated successful experience of specialization in the installation of the items or systems, or both, specified herein.
- C. Manufacturer: Contractor shall obtain products from nationally and industry recognized Manufacturer with five (5) years minimum, of immediately recent, continuous, documented and properly authenticated successful experience of specialization in the manufacture of the product specified herein.
- D. State Personnel Training: Provide proper training for maintenance and operations, including emergency procedures, and the like, as directed by Owner.
- E. Units: Shall be sound and free of defects, and shall not include any damage or defect that will impair the safety, installation, performance, or the durability of the entire Office Trailer and appurtenant systems.

## **1.06 REGULATORY REQUIREMENTS**

- A. General: Work shall be executed in accordance with applicable Codes, Regulations, Statutes, Enactment’s, Rulings, Laws, each authority having jurisdiction, and including, but not limited to, Regulatory Requirements specified herein.
- B. California Building Standards Code (“CBSC”).
- C. California Code of Regulations, Title 25, Chapter 3, Sub Chapter 2, Article 3 (“CCR”).

- D. Coach Insignia: Trailer shall display California Commercial Coach Insignia; such insignia shall be deemed to show that the trailer is in accordance with the Construction and Fire Safety requirements of CCR.

## **PART 2 – PRODUCTS**

### **2.01 FIELD OFFICE TRAILER**

- A. General: Provide entire Field Office Trailer of type, function, operation, capacity, size, complete with controls, safety devices, accessories, and the like, for proper and durable installation. Partitions, walls, ceiling, and other interior and exterior surfaces shall be appropriately finished, including, but not limited to, trim, painting, wall base, floor covering, suspended or similar ceiling, and the like; provide systems, components, units, nuts, bolts, screws, anchoring devices, fastening devices, washers, accessories, adhesives, sealants, and other items of type, grade, and class required for the particular use, not identified but required for a complete, weather-tight, appropriately operating, and finished installation.
- B. Manufacturers: General Electric Capital Modular Space; The Space Place, Inc.; or equal.
- C. Program: Provide a wheel-mounted trailer with stairs, landings, platforms, ramps, stairs, platforms, and the like, in good, proper, safe, clean, and properly finished condition; with proper heavy duty locks, and other proper and effective security at all doors, windows, and the like. Trailer shall be maintained in good, proper, safe, clean, and properly finished condition during the Contract.
- (1) Nominal Trailer Size: Four hundred eighty (480) square feet, minimum.
  - (2) Stairs, Platform: Properly finished stairs, platforms, and ramps.
  - (3) Doors: Two (2), three (3) foot wide exterior doors with locksets; finished ramp, steps, and entry platform at each exterior door.
  - (4) Keys: Submit five (5) keys for each door, window, furniture unit, and the like, there shall be no other key copies or originals available; each key shall be identified for Owner; and shall be labeled, or tagged or both, as directed by Owner.
  - (5) HVAC: **[PROVIDE DESCRIPTION OR DELETE]**
  - (6) Lighting: Sixty-five (65) foot-candles illumination minimum at any point, at thirty (30) inches above finished floor throughout from fluorescent light source, exclusively, or as directed by Owner.
  - (7) Electrical Outlets: One (1) duplex outlet evenly spaced every twelve (12) linear horizontal feet of wall face, and electrical service ready for use.

- (8) Telephones and Telephone Outlets: Two (2) telephone lines wired, connected to telephone utility service, and ready for use, and two (2) telephone instruments, each with two (2)-line capability, speed dial and hands-free feature. Locate each outlet as directed by Owner.
- (9) Answering Machine: One (1) unit, two (2)-line; digital.

## **2.02 FIELD OFFICE TRAILER ITEMS**

- A. General: Provide the Field Office Trailer with the following arranged into two (2) workstations:
  - (1) Desks: Two (2) desks: thirty-six (36) inches by sixty (60) inches; steel, laminated plastic top; locking, one (1) or two (2) file drawers single pedestal; steel; provide five (5) keys to Owner.
  - (2) Tables: Two (2) tables; thirty-six (36) inches by sixty (60) inches; twenty-nine (29) inches high; steel, laminated plastic top tables; one (1) at each desk.
  - (3) Chairs: Two (2) chairs: swivel; steel; with seat cushion and arms; one (1) at each desk.
  - (4) Waste Baskets: Two (2) waste baskets, one at each desk.
- B. Furniture and Equipment: Provide in the space located to effect efficient and logical use.
  - (1) File cabinet: One (1); four (4) drawer; lateral; steel locking.
  - (2) Plan Table: One (1) plan table: thirty-six (36) inches deep by seventy-two (72) inches wide by forty-two (42) inches high; adjustable; wood or steel; with lockable plan and pencil drawers.
  - (3) Drafting Stool: One (1) drafting stool; swiveling; steel; padded; adjustable; with footrest and casters.
  - (4) Bookshelf: One (1) bookshelf: thirty-six (36) inches deep by seventy-two (72) inches wide by forty-two (42) inches high; adjustable; wood or steel; with lockable plan and pencil drawer.
  - (5) Plan Rack: One (1) wheel mounted plan rack.
  - (6) Waste Baskets: One (1) large waste basket.
  - (7) Coat/Hat Hanger: Wall mounted with minimum capacity for four (4) garments and ten (10) hats.

- (8) Document Management System: Shall include an integrated high-volume printer, copier, and facsimile machine, including stand, base, and storage cabinet; and shall include the following features:
- (a) Type: Laser, dry electrostatic transfer, plain paper, digital, multi-function imaging system.
  - (b) Network: Ethernet or Token Ring network ready, Plug-and-Play.
  - (c) Print, send/receive facsimile from any connected workstation.
  - (d) Resolution: Six hundred (600) dots per inch by six hundred (600) dots per inch, minimum.
  - (e) Print Speed: Twenty (20) pages per minute, minimum.
  - (f) Copies: Twenty (20) copies per minute, minimum.
  - (g) Document Handler: Forty (40) sheet, minimum
  - (h) Collator: Forty (40) bin, minimum, with stapling.
  - (i) Duplexing: Capable.
  - (j) Paper Size: Capable of handling paper sizes to eleven (11) inches by seventeen (17) inches.
  - (k) Paper Cassettes: One (1) each for eight and one half (8.5) inches by eleven (11) inches, eight and one half (8.5) inches by fourteen (14) inches, and eleven (11) inches by seventeen (17) inches paper sizes; minimum two hundred fifty (250) sheets per cassette.
  - (l) Reduction/Enlargement: Capable of reduction to twenty-five percent (25%) and enlargement to two hundred percent (200%).
  - (m) Facsimile Electronic Storage: Capable of storing minimum of fifty (50) speed dial numbers, group faxing and broadcast faxing.
  - (n) Facsimile Scanning: Capable of scanning into memory a minimum of one hundred (100) pages with maximum scan time of three (3) seconds per page.
  - (o) Halftone: Sixty-four (64) levels.
  - (p) Redial: Automatic and Manual.
- (9) Maintenance: Contractor shall purchase service agreements for each unit of equipment for the duration of the project plus two (2) months, and shall maintain all equipment in proper working condition. Service agreements shall include

provision for replacement of toner cartridges and other items required to effect proper unit use. Service agreements shall also provide for:

- (a) Unlimited Service Calls.
  - (b) Same Day Response.
  - (c) All parts, labor, preventative maintenance and mileage.
  - (d) All chemicals, such as toner, fixing agent, and the like.
  - (e) System training and setup.
- (10) Portable Toilets: Two (2); each shall include a urinal; each unit shall be a properly enclosed chemical unit conforming to ANSI Z4.3.
- (a) Location: As directed by Owner.
  - (b) Maintenance: Maintain each unit and surrounding areas in a clean, hygienic and orderly manner, at all time. Empty, clean, and sanitize each unit each day at a location and time as directed by Owner.
  - (c) Removal: Relocate, or remove from the site, each Portable Toilet. Upon such directive by Owner, the Contractor shall forthwith relocate or remove each Portable Toilet and submit the affected areas to a condition which existed prior to the installation of each Portable Toilet, within three (3) calendar days, or as directed by Owner in writing, at no cost to Owner.

## **2.03 UTILITY AND SERVICES**

- A. Telephone Service: Contractor shall provide and interface the entire telephone service, and shall properly and timely pay for telephone service for Owner's non-long-distance use.
- B. Electrical Service: Provide all proper connections and continuously pay for service for the duration of the Work.

## **2.04 FINISHES**

- A. General: Manufacturer standard finish system over surfaces properly cleaned, pretreated, and prepared to obtain proper bond; all visible surfaces shall be coated.
- B. Finish: Color as selected by Owner from manufacturer standard palette.

## PART 3 – EXECUTION

### 3.01 INSTALLATION

- A. General: Properly prepare area and affected items to receive the Work. Set Work accurately in location, alignment, and elevation; rigidly, securely, and firmly anchor to appropriate structure; install plumb, straight, square, level, true, without racking, rigidly anchored to proper solid blocking, substrate, and the like; provide appropriate type and quantity of reinforcements, fasteners, adhesives, self-adhesive and other tapes; lubricants, coatings, accessories, and the like, as required for a complete, structurally rigid, stable, sound, and appropriately finished installation, in accordance with manufacturer's published instructions, and as indicated. The more restrictive and higher quality requirement shall govern. Moving parts shall be properly secured, without binding, looseness, noise, and the like.
- B. Installation: Install in accordance with 25 CCR 3.2.3 and as directed by Owner; jack up trailer and level both ways; mount on proper concrete piers with all load off wheels; provide required tie down and accessories per Section 4368 of referenced CCR, and as directed by Owner.
- C. Rejected Work: Work, materials, unit, items, systems, and the like, not accepted by Owner shall be deemed rejected, and shall forthwith be removed and replaced with proper and new Work, materials, unit, items, systems, and the like at no cost to Owner.
- D. Standard: Comply with manufacturer's published instructions, or with instructions as shown or indicated; the more restrictive and higher quality requirement shall govern.
- E. Location: As directed by Owner.
- F. Fire Resistance: Construct and install in accordance with UL requirements.
- G. Maintenance: Contractor shall maintain trailer and adjacent areas in a safe, clean and hygienic condition throughout the duration of the Work, and as directed by Owner. Properly repair or replace furniture or other items, as directed by Owner. Properly remove unsafe, damaged, or broken furniture, or similar items, and replace with safe and proper items. Contractor shall pay cost of all services, repair, and maintenance, or replacement of each item.
- H. Janitorial Service: Provide professional janitorial services, including, but not limited to, trash, waste paper baskets, fill paper dispensers; clean and dust all furniture, files, and the like; sweep and mop resilient and similar flooring; and vacuum carpeting and similar flooring.
  - (1) Frequency: Two (2) times per week, minimum.

- I. Removal: Properly remove the Office Trailer and contents from the Site upon completion of the Contract, or as directed by Owner in writing. Forthwith properly patch and repair affected areas; replace damaged items with new items. Carefully and properly inventory, clean, pack, store, and protect Owner property; submit Owner property to Owner at a date, time and location as directed by Owner.

END OF SECTION



## PRODUCT REQUIREMENTS

### PART 1 - GENERAL

#### 1.01 RELATED DOCUMENTS:

- A. Drawings and general provisions of the Contract, including General Conditions and other Division 01 Specification Sections, apply to this Section.

#### 1.02 SUMMARY:

- A. Section includes administrative and procedural requirements for selection of products for use in Project; product delivery, storage, and handling; manufacturers' standard warranties on products; special warranties; and comparable products.
- B. Related Sections:
  - (1) Section 01 25 13 "Product Options and Substitutions" for requests for substitutions.
  - (2) Section 01 42 19 "References" for applicable industry standards for products specified.

#### 1.03 DEFINITIONS:

- A. Products: Items obtained for incorporating into the Work, whether purchased for Project or taken from previously purchased stock. The term "product" includes the terms "material," "equipment," "system," and terms of similar intent.
  - (1) Named Products: Items identified by manufacturer's product name, including make or model number or other designation shown or listed in manufacturer's published product literature, that is current as of date of the Contract Documents.
  - (2) New Products: Items that have not previously been incorporated into another project or facility. Products salvaged or recycled from other projects are not considered new products.
  - (3) Comparable Product: Product that is demonstrated and approved through submittal process to have the indicated qualities related to type, function, dimension, in-service performance, physical properties, appearance, and other characteristics that equal or exceed those of specified product.

- B. Basis-of-Design Product Specification: A specification in which a specific manufacturer's product is named and accompanied by the words "basis-of-design product," including make or model number or other designation, to establish the significant qualities related to type, function, dimension, in-service performance, physical properties, appearance, and other characteristics for purposes of evaluating comparable products of additional manufacturers named in the specification.

#### **1.04 ACTION SUBMITTALS:**

- A. Comparable Product Requests: Submit request for consideration of each comparable product. Identify product or fabrication or installation method to be replaced. Include Specification Section number and title and Drawing numbers and titles.
  - (1) Include data to indicate compliance with the requirements specified in "Comparable Products" Article.
  - (2) Architect's Action: If necessary, Architect will request additional information or documentation for evaluation within one week of receipt of a comparable product request. Architect will notify Contractor of approval or rejection of proposed comparable product request within 15 days of receipt of request, or seven days of receipt of additional information or documentation, whichever is later.
    - (a) Form of Approval: As specified in Section 01 33 00 "Submittals."
    - (b) Use product specified if Architect does not issue a decision on use of a comparable product request within time allocated.
- B. Basis-of-Design Product Specification Submittal: Comply with requirements in Section 01 3300 "Submittals." Show compliance with requirements.

#### **1.05 QUALITY ASSURANCE:**

- A. Compatibility of Options: If Contractor is given option of selecting between two or more products for use on Project, select product compatible with products previously selected, even if previously selected products were also options.
  - 1. Each contractor is responsible for providing products and construction methods compatible with products and construction methods of other contractors.
  - 2. If a dispute arises between contractors over concurrently selectable but incompatible products, Architect will determine which products shall be used.

## **1.06 PRODUCT DELIVERY, STORAGE, AND HANDLING:**

- A. Deliver, store, and handle products using means and methods that will prevent damage, deterioration, and loss, including theft and vandalism. Comply with manufacturer's written instructions.
- B. Delivery and Handling:
  - (1) Schedule delivery to minimize long-term storage at Project site and to prevent overcrowding of construction spaces.
  - (2) Coordinate delivery with installation time to ensure minimum holding time for items that are flammable, hazardous, easily damaged, or sensitive to deterioration, theft, and other losses.
  - (3) Deliver products to Project site in an undamaged condition in manufacturer's original sealed container or other packaging system, complete with labels and instructions for handling, storing, unpacking, protecting, and installing.
  - (4) Inspect products on delivery to determine compliance with the Contract Documents and to determine that products are undamaged and properly protected.
- C. Storage:
  - (1) Store products to allow for inspection and measurement of quantity or counting of units.
  - (2) Store materials in a manner that will not endanger Project structure.
  - (3) Store products that are subject to damage by the elements, under cover in a weathertight enclosure above ground, with ventilation adequate to prevent condensation.
  - (4) Protect foam plastic from exposure to sunlight, except to extent necessary for period of installation and concealment.
  - (5) Comply with product manufacturer's written instructions for temperature, humidity, ventilation, and weather-protection requirements for storage.
  - (6) Protect stored products from damage and liquids from freezing.
  - (7) Provide a secure location and enclosure at Project site for storage of materials and equipment by Owner's construction forces. Coordinate location with Owner.

## **1.07 PROJECT WARRANTIES:**

- A. Warranties specified in other Sections shall be in addition to, and run concurrent with, other warranties required by the Contract Documents. Manufacturer's disclaimers and limitations on product warranties do not relieve Contractor of obligations under requirements of the Contract Documents.
  - 1. Manufacturer's Warranty: Written warranty furnished by individual manufacturer for a particular product and specifically endorsed by manufacturer to Owner.
  - 2. Special Warranty: Written warranty required by the Contract Documents to provide specific rights for Owner.
- B. Special Warranties: Prepare a written document that contains appropriate terms and identification, ready for execution.
  - 1. Manufacturer's Standard Form: Modified to include Project-specific information and properly executed.
  - 2. Specified Form: When specified forms are included with the Specifications, prepare a written document using indicated form properly executed.
  - 3. See other Sections for specific content requirements and particular requirements for submitting special warranties.
- C. Submittal Time: Comply with requirements in Section 0177 00 "Contract Closeout and Final Cleaning."

## **PART 2 – PRODUCTS**

### **2.01 PRODUCT SELECTION PROCEDURES**

- A. General Product Requirements: Provide products that comply with the Contract Documents, are undamaged and, unless otherwise indicated, are new at time of installation.
  - (1) Provide products complete with accessories, trim, finish, fasteners, and other items needed for a complete installation and indicated use and effect.
  - (2) Standard Products: If available, and unless custom products or nonstandard options are specified, provide standard products of types that have been produced and used successfully in similar situations on other projects.
  - (3) Owner reserves the right to limit selection to products with warranties not in conflict with requirements of the Contract Documents.

- (4) Where products are accompanied by the term "as selected," Architect will make selection.
- (5) Descriptive, performance, and reference standard requirements in the Specifications establish salient characteristics of products.
- (6) Or Equal: For products specified by name and accompanied by the term "or equal," or "or approved equal," or "or approved," comply with requirements in "Comparable Products" Article to obtain approval for use of an unnamed product.

B. Product Selection Procedures:

- (1) Product: Where Specifications name a single manufacturer and product, provide the named product that complies with requirements. Comparable products or substitutions for Contractor's convenience will not be considered.
- (2) Manufacturer/Source: Where Specifications name a single manufacturer or source, provide a product by the named manufacturer or source that complies with requirements. Comparable products or substitutions for Contractor's convenience will not be considered.
- (3) Products:
  - (a) Restricted List: Where Specifications include a list of names of both manufacturers and products, provide one of the products listed that complies with requirements. Comparable products or substitutions for Contractor's convenience will be considered.
  - (b) Nonrestricted List: Where Specifications include a list of names of both available manufacturers and products, provide one of the products listed, or an unnamed product, that complies with requirements. Comply with requirements in "Comparable Products" Article for consideration of an unnamed product.
- (4) Manufacturers:
  - (a) Restricted List: Where Specifications include a list of manufacturers' names, provide a product by one of the manufacturers listed that complies with requirements. Comparable products or substitutions for Contractor's convenience will not be considered unless otherwise indicated.

(b) Nonrestricted List: Where Specifications include a list of available manufacturers, provide a product by one of the manufacturers listed, or a product by an unnamed manufacturer, that complies with requirements. Comply with requirements in "Comparable Products" Article for consideration of an unnamed manufacturer's product.

(5) Basis-of-Design Product: Where Specifications name a product, or refer to a product indicated on Drawings, and include a list of manufacturers, provide the specified or indicated product or a comparable product by one of the other named manufacturers. Drawings and Specifications indicate sizes, profiles, dimensions, and other characteristics that are based on the product named. Comply with requirements in "Comparable Products" Article for consideration of an unnamed product by one of the other named manufacturers.

C. Visual Matching Specification: Where Specifications require "match Architect's sample," provide a product that complies with requirements and matches Architect's sample. Architect's decision will be final on whether a proposed product matches.

(1) If no product available within specified category matches and complies with other specified requirements, comply with requirements in Section 01 25 13 "Product Options and Substitutions" for proposal of product.

D. Visual Selection Specification: Where Specifications include the phrase "as selected by Architect from manufacturer's full range" or similar phrase, select a product that complies with requirements. Architect will select color, gloss, pattern, density, or texture from manufacturer's product line that includes both standard and premium items.

## **2.02 COMPARABLE PRODUCTS**

A. Conditions for Consideration: Architect will consider Contractor's request for comparable product when the following conditions are satisfied. If the following conditions are not satisfied, Architect may return requests without action, except to record noncompliance with these requirements:

(1) Evidence that the proposed product does not require revisions to the Contract Documents, that it is consistent with the Contract Documents and will produce the indicated results, and that it is compatible with other portions of the Work.

(2) Detailed comparison of significant qualities of proposed product with those named in the Specifications. Significant qualities include attributes such as performance, weight, size, durability, visual effect, and specific features and requirements indicated.

- (3) Evidence that proposed product provides specified warranty.
- (4) List of similar installations for completed projects with project names and addresses and names and addresses of architects and owners, if requested.
- (5) Samples, if requested.

**PART 3 – EXECUTION (Not Used)**

END OF SECTION

## **OWNER-FURNISHED PRODUCTS**

### **PART 1 – GENERAL**

#### **1.01 RELATED DOCUMENTS AND PROVISIONS:**

All Contract Documents should be reviewed for applicable provisions related to the provisions in this document, including without limitation:

- A. General Conditions; and
- B. Agreement.

#### **1.02 SECTION INCLUDES:**

- A. Requirements for the following:
  - (1) Installing Owner-furnished materials and equipment.
  - (2) Providing necessary utilities, connections and rough-ins.

#### **1.03 DEFINITIONS**

- A. Owner: Owner, who is providing/furnishing materials and equipment.
- B. Installer Contactor: Contractor, who is installing the materials and equipment furnished by the Owner.

#### **1.04 PRODUCT DELIVERY, STORAGE, AND HANDLING:**

- A. Receive, store and handle products in accordance with the manufacturer's instructions.
- B. Protect equipment items as required to prevent damage during storage and construction.

### **PART 2 – PRODUCTS**

#### **2.01 GENERAL PRODUCT REQUIREMENTS:**

- A. Installer Contractor's Responsibilities:
  - (1) Verify mounting and utility requirements for Owner-furnished materials and equipment items.
  - (2) Provide mounting and utility rough in for all items where required.



- (a) Rough in locations, sizes, capacities, and similar type items shall be as indicated and required by product manufacturer.

B. Owner and Installer Contractor(s) Responsibilities:

- (1) Owner-Furnished/Contractor Installed (“OFCI”): Furnished by the Owner; installed by the Installer Contractor.
  - (a) General: Owner and Installer Contractor(s) will coordinate deliveries of materials and equipment to coincide with the construction schedule.
  - (b) Owner will furnish specified materials and equipment delivered to the site. Owner/vendor’s representative shall be present on Site at the time of delivery to comply with the contract requirements and Specifications Section 01 43 00, Materials and Equipment, Article 1.04.
  - (c) The Owner furnishing specified materials and equipment is responsible to provide manufacturer guarantees as required by the Contract to the Installer Contractor.
  - (d) The Installer Contractor shall:
    - 1) Review, verify and accept the approved manufacturer’s submittal/Shop Drawings for all materials and equipment required to be installed by the Installer Contractor and furnished by the Owner. Any discrepancies, including but not limited to possible space conflicts, should be brought to the attention of the Project Manager and/or Program Manager, if applicable.
    - 2) Coordinate timely delivery. Installer Contractor shall receive materials and equipment at Site when delivered and give written receipt at time of delivery, noting visible defects or omissions; if such declaration is not given, the Installer Contractor shall assume responsibility for such defects and omissions.
    - 3) Store materials and equipment until ready for installation and protect from loss and damage. Installer Contractor is responsible for providing adequate storage space.
    - 4) Coordinate with other bid package contractors and field measurement to ensure complete installation.
    - 5) Uncrate, assemble, and set in place.

- 6) Provide adequate supports.
- 7) Install materials and equipment in accordance with manufacturer's recommendations, instructions, and Shop Drawings, supply labor and material required, and make mechanical, plumbing, and electrical connections required to operate equipment.
- 8) Be certified by equipment manufacturer for installation of the specific equipment supplied by the Owner.
- 9) Provide anchorage and/or bracing as required for seismic restraint per Title 24, UBC Standard 27-11 and all other applicable codes.
- 10) Provide the contract-required warranty and guarantee for all work, materials, equipment, and installation upon its completion and acceptance by the Owner. Guarantee includes all costs associated with the removal, shipping to and from the Site, and re-installation of any equipment found to be defective.

C. Compatibility with Space and Service Requirements:

- (1) Equipment items shall be compatible with space limitations indicated and as shown on the Contract Documents and specified in other sections of the Specifications.
- (2) Modifications to equipment items required to conform to space limitations specified for rough in shall not cause additional cost to the Owner.

D. Manufacturer's printed descriptions, specifications, and instructions shall govern the Work unless specifically indicated or specified otherwise.

## 2.02 FURNISHED MATERIALS AND EQUIPMENT

A. All furnished materials and equipment are indicated or scheduled on the Contract Documents.

## PART 3 – EXECUTION

### 3.01 INSTALLATION

- A. Install equipment items in accordance with the manufacturer's instructions.
- B. Set equipment items securely in place, rigidly or flexibly mounted in accordance with manufacturers' directions.

- C. Make electrical and mechanical connections as indicated and required.
- D. Touch-up and restore damaged or defaced finishes to the Owner's satisfaction.

**3.02 CLEANING AND PROTECTION**

- A. Repair or replace items not acceptable to the Architect.
- B. Upon completion of installation, clean equipment items in accordance with manufacturer's recommendations, and protect from damage until final acceptance of the Work by the Owner.

END OF SECTION

## **PRODUCT DELIVERY, STORAGE AND HANDLING**

### **PART 1 - GENERAL**

#### **1.01 RELATED DOCUMENTS AND PROVISIONS**

All Contract Documents should be reviewed for applicable provisions related to the provisions in this document, including without limitation:

- A. General Conditions, including, without limitation, Site Access;
- B. Special Conditions.

#### **1.02 PRODUCTS**

- A. Contractor shall not use and/or reuse materials and/or equipment removed from existing Premises, except as specifically permitted by the Contract Documents.
- B. Contractor shall provide interchangeable components of the same manufacturer, for similar components.

#### **1.03 TRANSPORTATION AND HANDLING**

- A. Contractor shall transport and handle products in accordance with manufacturer's instructions.
- B. Contractor shall promptly inspect shipments to confirm that products comply with requirements, quantities are correct, and products are undamaged.
- C. Contractor shall provide equipment and personnel to handle products by methods to prevent soiling, disfigurement, or damage.

#### **1.04 STORAGE AND PROTECTION**

- A. Contractor shall store and protect products in accordance with manufacturer's instructions, with seals and labels intact and legible. Contractor shall store sensitive products in weather-tight, climate controlled enclosures.
- B. For exterior storage of fabricated products, Contractor shall place on sloped supports, above ground.
- C. Contractor shall provide off-site storage and protection when Site does not permit on-site storage or protection.
  - (1) Storage shall be a secure and bonded warehouse. Payment will not be made by the Owner for materials stored off-site, until such time as the materials are incorporated into the Work.

- D. Contractor shall cover products subject to deterioration with impervious sheet covering and provide ventilation to avoid condensation.
- E. Contractor shall store loose granular materials on solid flat surfaces in a well-drained area and prevent mixing with foreign matter.
- F. Contractor shall provide equipment and personnel to store products by methods to prevent soiling, disfigurement, or damage.
- G. Contractor shall arrange storage of products to permit access for inspection and periodically inspect to assure products are undamaged and are maintained under specified conditions.

**PART 2 – PRODUCTS (Not Used)**

**PART 3 - EXECUTION (Not Used)**

END OF SECTION

## **FIELD ENGINEERING**

### **PART 1 - GENERAL**

#### **1.01 RELATED DOCUMENTS AND PROVISIONS:**

All Contract Documents should be reviewed for applicable provisions related to the provisions in this document, including without limitation:

- A. General Conditions; and
- B. Agreement.

#### **1.02 REQUIREMENTS INCLUDED:**

- A. Contractor shall provide and pay for field engineering services by a California-registered engineer, required for the project, including, without limitations:
  - (1) Survey work required in execution of the Project.
  - (2) Civil or other professional engineering services specified, or required to execute Contractor's construction methods.

#### **1.03 QUALIFICATIONS OF SURVEYOR OR ENGINEERS:**

Contractor shall only use a qualified licensed engineer or registered land surveyor, to whom Owner makes no objection.

#### **1.04 SURVEY REFERENCE POINTS:**

- A. Existing basic horizontal and vertical control points for the Project are those designated on the Drawings.
- B. Contractor shall locate and protect control points prior to starting Site Work and preserve all permanent reference points during construction. In addition Contractor shall:
  - (1) Make no changes or relocation without prior written notice to Owner and Architect.
  - (2) Report to Owner and Architect when any reference point is lost or destroyed, or requires relocation because of necessary changes in grades or locations.
  - (3) Require surveyor to replace Project control points based on original survey control that may be lost or destroyed.

### **1.05 RECORDS:**

Contractor shall maintain a complete, accurate log of all control and survey work as it progresses.

### **1.06 SUBMITTALS:**

- A. Contractor shall submit name and address of Surveyor and Professional Engineer to Owner and Architect prior to its/their work on the Project.
- B. On request of Owner and Architect, Contractor shall submit documentation to verify accuracy of field engineering work, at no additional cost to the Owner.
- C. Contractor shall submit a certificate signed by registered engineer or surveyor certifying that elevations and locations of improvements are in conformance or nonconformance with Contract Documents.

## **PART 2 – PRODUCTS (Not Used)**

## **PART 3 - EXECUTION**

### **3.01 COMPLIANCE WITH LAWS:**

Contractor is responsible for meeting all applicable codes, OSHA, safety and shoring requirements.

### **3.02 NONCONFORMING WORK:**

Contractor is responsible for any re-surveying required by correction of nonconforming work.

END OF SECTION

## **execution**

### **PART 1 - GENERAL**

#### **1.01 RELATED DOCUMENTS:**

- A. Drawings and general provisions of the Contract, including General Conditions and other Division 01 Specification Sections, apply to this Section.

#### **1.02 SUMMARY:**

- A. Section includes general administrative and procedural requirements governing execution of the Work including, but not limited to, the following:

- (1) Construction layout.
- (2) Field engineering and surveying.
- (3) Installation of the Work.
- (4) Cutting and patching.
- (5) Coordination of Owner-installed products.
- (6) Progress cleaning.
- (7) Starting and adjusting.
- (8) Protection of installed construction.

- B. Related Sections:

- 3. Section 01 11 00 "Summary of Work" for limits on use of Project site.
- 4. Section 01 33 00 "Submittals" for submitting surveys.
- (9) Section 01 77 00 "Contract Closeout and Final Cleaning " for submitting final property survey with Project Record Documents, recording of Owner-accepted deviations from indicated lines and levels, and final cleaning.

#### **1.03 DEFINITIONS:**

- A. Cutting: Removal of in-place construction necessary to permit installation or performance of other work.
- B. Patching: Fitting and repair work required to restore construction to original conditions after installation of other work.



#### **1.04 INFORMATIONAL SUBMITTALS:**

- A. Qualification Data: For land surveyor.
- B. Certificates: Submit certificate signed by land surveyor certifying that location and elevation of improvements comply with requirements.
- C. Certified Surveys: Submit one copies signed by land surveyor.
- D. Final Property Survey: Submit one copies showing the Work performed and record survey data.

#### **1.05 QUALITY ASSURANCE:**

- A. Land Surveyor Qualifications: A professional land surveyor who is legally qualified to practice in jurisdiction where Project is located and who is experienced in providing land- surveying services of the kind indicated.
- B. Cutting and Patching: Comply with requirements for and limitations on cutting and patching of construction elements.
  - 5. Structural Elements: When cutting and patching structural elements, notify Architect of locations and details of cutting and await directions from Architect before proceeding. Shore, brace, and support structural elements during cutting and patching. Do not cut and patch structural elements in a manner that could change their load-carrying capacity or increase deflection.
  - 6. Operational Elements: Do not cut and patch operating elements and related components in a manner that results in reducing their capacity to perform as intended or that results in increased maintenance or decreased operational life or safety. Operational elements include the following:
    - (a) Primary operational systems and equipment.
    - (b) Fire separation assemblies.
    - (c) Air or smoke barriers.
    - (d) Fire-suppression systems.
    - (e) Mechanical systems piping and ducts.
    - (f) Control systems.
    - (g) Communication systems.
    - (h) Fire-detection and -alarm systems.

- (i) Conveying systems.
  - (j) Electrical wiring systems.
  - (k) Operating systems of special construction.
- (10) Other Construction Elements: Do not cut and patch other construction elements or components in a manner that could change their load-carrying capacity, that results in reducing their capacity to perform as intended, or that results in increased maintenance or decreased operational life or safety. Other construction elements include but are not limited to the following:
- (a) Water, moisture, or vapor barriers.
  - (b) Membranes and flashings.
  - (c) Exterior curtain-wall construction.
  - (d) Sprayed fire-resistive material.
  - (e) Equipment supports.
  - (f) Piping, ductwork, vessels, and equipment.
  - (g) Noise and vibration-control elements and systems.
- (11) Visual Elements: Do not cut and patch construction in a manner that results in visual evidence of cutting and patching. Do not cut and patch exposed construction in a manner that would, in Architect's opinion, reduce the building's aesthetic qualities. Remove and replace construction that has been cut and patched in a visually unsatisfactory manner.
- C. Cutting and Patching Conference: Before proceeding, meet at Project site with parties involved in cutting and patching, including mechanical and electrical trades. Review areas of potential interference and conflict. Coordinate procedures and resolve potential conflicts before proceeding.
- D. Manufacturer's Installation Instructions: Obtain and maintain on-site manufacturer's written recommendations and instructions for installation of products and equipment.

## **PART 2 – PRODUCTS**

### **2.01 MATERIALS**

- A. General: Comply with requirements specified in other Sections.
  - b. For projects requiring compliance with sustainable design and construction practices and procedures, use products for patching that comply with sustainable design requirements.
  
- B. In-Place Materials: Use materials for patching identical to in-place materials. For exposed surfaces, use materials that visually match in-place adjacent surfaces to the fullest extent possible.
  - (1) If identical materials are unavailable or cannot be used, use materials that, when installed, will provide a match acceptable to Architect for the visual and functional performance of in-place materials.

## **PART 3 – EXECUTION**

### **3.01 EXAMINATION**

- A. Existing Conditions: The existence and location of underground and other utilities and construction indicated as existing are not guaranteed. Before beginning sitework, investigate and verify the existence and location of underground utilities, mechanical and electrical systems, and other construction affecting the Work.
  - 1. Before construction, verify the location and invert elevation at points of connection of sanitary sewer, storm sewer, and water-service piping; underground electrical services, and other utilities.
  - 2. Furnish location data for work related to Project that must be performed by public utilities serving Project site.
  
- B. Examination and Acceptance of Conditions: Before proceeding with each component of the Work, examine substrates, areas, and conditions, with Installer or Applicator present where indicated, for compliance with requirements for installation tolerances and other conditions affecting performance. Record observations.
  - 1. Examine roughing-in for mechanical and electrical systems to verify actual locations of connections before equipment and fixture installation.
  - 2. Examine walls, floors, and roofs for suitable conditions where products and systems are to be installed.
  - 3. Verify compatibility with and suitability of substrates, including compatibility with existing finishes or primers.

C. Written Report: Where a written report listing conditions detrimental to performance of the Work is required by other Sections, include the following:

1. Description of the Work.
2. List of detrimental conditions, including substrates.
3. List of unacceptable installation tolerances.
4. Recommended corrections.

D. Proceed with installation only after unsatisfactory conditions have been corrected. Proceeding with the Work indicates acceptance of surfaces and conditions.

### **3.02 PREPARATION**

A. Existing Utility Information: Furnish information to Owner that is necessary to adjust, move, or relocate existing utility structures, utility poles, lines, services, or other utility appurtenances located in or affected by construction. Coordinate with authorities having jurisdiction.

B. Field Measurements: Take field measurements as required to fit the Work properly. Recheck measurements before installing each product. Where portions of the Work are indicated to fit to other construction, verify dimensions of other construction by field measurements before fabrication. Coordinate fabrication schedule with construction progress to avoid delaying the Work.

C. Space Requirements: Verify space requirements and dimensions of items shown diagrammatically on Drawings.

D. Review of Contract Documents and Field Conditions: Immediately on discovery of the need for clarification of the Contract Documents caused by differing field conditions outside the control of Contractor, submit a request for information to Architect according to requirements in Section 01 31 00 "Project Management and Coordination."

### **3.03 CONSTRUCTION LAYOUT**

A. Verification: Before proceeding to lay out the Work, verify layout information shown on Drawings, in relation to the property survey and existing benchmarks. If discrepancies are discovered, notify Architect promptly.

B. General: Engage a land surveyor to lay out the Work using accepted surveying practices.

{SR555211}

EXECUTION  
DOCUMENT 01 73 182

- 5. Establish benchmarks and control points to set lines and levels at each story of construction and elsewhere as needed to locate each element of Project.
  - 6. Establish limits on use of Project site.
- (12) Establish dimensions within tolerances indicated. Do not scale Drawings to obtain required dimensions.
  - (13) Inform installers of lines and levels to which they must comply.
  - (14) Check the location, level and plumb, of every major element as the Work progresses.
  - (15) Notify Architect when deviations from required lines and levels exceed allowable tolerances.
  - (16) Close site surveys with an error of closure equal to or less than the standard established by authorities having jurisdiction.

C. Site Improvements: Locate and lay out site improvements, including pavements, grading, fill and topsoil placement, utility slopes, and rim and invert elevations.

D. Building Lines and Levels: Locate and lay out control lines and levels for structures, building foundations, column grids, and floor levels, including those required for mechanical and electrical work. Transfer survey markings and elevations for use with control lines and levels. Level foundations and piers from two or more locations.

E. Record Log: Maintain a log of layout control work. Record deviations from required lines and levels. Include beginning and ending dates and times of surveys, weather conditions, name and duty of each survey party member, and types of instruments and tapes used. Make the log available for reference by Architect.

### **3.04 FIELD ENGINEERING**

A. Identification: Owner will identify existing benchmarks, control points, and property corners.

B. Reference Points: Locate existing permanent benchmarks, control points, and similar reference points before beginning the Work. Preserve and protect permanent benchmarks and control points during construction operations.

- (1) Do not change or relocate existing benchmarks or control points without prior written approval of Architect. Report lost or destroyed permanent

benchmarks or control points promptly. Report the need to relocate permanent benchmarks or control points to Architect before proceeding.

- (2) Replace lost or destroyed permanent benchmarks and control points promptly. Base replacements on the original survey control points.

C. Benchmarks: Establish and maintain a minimum of two permanent benchmarks on Project site, referenced to data established by survey control points. Comply with authorities having jurisdiction for type and size of benchmark.

- (1) Record benchmark locations, with horizontal and vertical data, on Project Record Documents.
- (2) Where the actual location or elevation of layout points cannot be marked, provide temporary reference points sufficient to locate the Work.
- (3) Remove temporary reference points when no longer needed. Restore marked construction to its original condition.

D. Certified Survey: On completion of foundation walls, major site improvements, and other work requiring field-engineering services, prepare a certified survey showing dimensions, locations, angles, and elevations of construction and sitework.

E. Final Property Survey: Engage a land surveyor to prepare a final property survey showing significant features (real property) for Project. Include on the survey a certification, signed by land surveyor, that principal metes, bounds, lines, and levels of Project are accurately positioned as shown on the survey.

- (1) Show boundary lines, monuments, streets, site improvements and utilities, existing improvements and significant vegetation, adjoining properties, acreage, grade contours, and the distance and bearing from a site corner to a legal point.
- (2) Recording: At Substantial Completion, have the final property survey recorded by or with authorities having jurisdiction as the official "property survey."

### **3.05 INSTALLATION**

A. General: Locate the Work and components of the Work accurately, in correct alignment and elevation, as indicated.

- (1) Make vertical work plumb and make horizontal work level.

- indicated.
- (2) Where space is limited, install components to maximize space available for maintenance and ease of removal for replacement.
  - (3) Conceal pipes, ducts, and wiring in finished areas unless otherwise
  - (4) Maintain minimum headroom clearance of 96 inches in occupied spaces and 90 inches in unoccupied spaces.

B. Comply with manufacturer's written instructions and recommendations for installing products in applications indicated.

C. Install products at the time and under conditions that will ensure the best possible results. Maintain conditions required for product performance until Substantial Completion.

D. Conduct construction operations so no part of the Work is subjected to damaging operations or loading in excess of that expected during normal conditions of occupancy.

E. Sequence the Work and allow adequate clearances to accommodate movement of construction items on site and placement in permanent locations.

F. Tools and Equipment: Do not use tools or equipment that produce harmful noise levels.

G. Templates: Obtain and distribute to the parties involved templates for work specified to be factory prepared and field installed. Check Shop Drawings of other work to confirm that adequate provisions are made for locating and installing products to comply with indicated requirements.

H. Attachment: Provide blocking and attachment plates and anchors and fasteners of adequate size and number to securely anchor each component in place, accurately located and aligned with other portions of the Work. Where size and type of attachments are not indicated, verify size and type required for load conditions.

- (1) Mounting Heights: Where mounting heights are not indicated, mount components at heights directed by Architect.
- (2) Allow for building movement, including thermal expansion and contraction.
- (3) Coordinate installation of anchorages. Furnish setting drawings, templates, and directions for installing anchorages, including sleeves, concrete

inserts, anchor bolts, and items with integral anchors, that are to be embedded in concrete or masonry. Deliver such items to Project site in time for installation.

- I. Joints: Make joints of uniform width. Where joint locations in exposed work are not indicated, arrange joints for the best visual effect. Fit exposed connections together to form hairline joints.
- J. Hazardous Materials: Use products, cleaners, and installation materials that are not considered hazardous.

### **3.06 CUTTING AND PATCHING**

- A. Cutting and Patching, General: Employ skilled workers to perform cutting and patching. Proceed with cutting and patching at the earliest feasible time, and complete without delay.
  - (1) Cut in-place construction to provide for installation of other components or performance of other construction, and subsequently patch as required to restore surfaces to their original condition.
- B. Existing Warranties: Remove, replace, patch, and repair materials and surfaces cut or damaged during installation or cutting and patching operations, by methods and with materials so as not to void existing warranties.
- C. Temporary Support: Provide temporary support of work to be cut.
- D. Protection: Protect in-place construction during cutting and patching to prevent damage. Provide protection from adverse weather conditions for portions of Project that might be exposed during cutting and patching operations.
- E. Adjacent Occupied Areas: Where interference with use of adjoining areas or interruption of free passage to adjoining areas is unavoidable, coordinate cutting and patching according to requirements in Section 01 11 00 "Summary of Work."
- F. Existing Utility Services and Mechanical/Electrical Systems: Where existing services/systems are required to be removed, relocated, or abandoned, bypass such services/systems before cutting to minimize interruption to occupied areas.
- G. Cutting: Cut in-place construction by sawing, drilling, breaking, chipping, grinding, and similar operations, including excavation, using methods least likely to damage elements retained or adjoining construction. If possible, review proposed procedures with original Installer; comply with original Installer's written recommendations.



- (1) In general, use hand or small power tools designed for sawing and grinding, not hammering and chopping. Cut holes and slots neatly to minimum size required, and with minimum disturbance of adjacent surfaces. Temporarily cover openings when not in use.
- (2) Finished Surfaces: Cut or drill from the exposed or finished side into concealed surfaces.
- (3) Concrete and Masonry: Cut using a cutting machine, such as an abrasive saw or a diamond-core drill.
- (4) Excavating and Backfilling: Comply with requirements in applicable Sections where required by cutting and patching operations.
- (5) Mechanical and Electrical Services: Cut off pipe or conduit in walls or partitions to be removed. Cap, valve, or plug and seal remaining portion of pipe or conduit to prevent entrance of moisture or other foreign matter after cutting.
- (6) Proceed with patching after construction operations requiring cutting are complete.

H. Patching: Patch construction by filling, repairing, refinishing, closing up, and similar operations following performance of other work. Patch with durable seams that are as invisible as practicable. Provide materials and comply with installation requirements specified in other Sections, where applicable.

- (1) Inspection: Where feasible, test and inspect patched areas after completion to demonstrate physical integrity of installation.
- (2) Exposed Finishes: Restore exposed finishes of patched areas and extend finish restoration into retained adjoining construction in a manner that will minimize evidence of patching and refinishing.
  - (a) Clean piping, conduit, and similar features before applying paint or other finishing materials.
  - (b) Restore damaged pipe covering to its original condition.
- (3) Floors and Walls: Where walls or partitions that are removed extend one finished area into another, patch and repair floor and wall surfaces in the new space. Provide an even surface of uniform finish, color, texture, and appearance. Remove in-place floor and wall coverings and replace with new materials, if necessary, to achieve uniform color and appearance.

- (a) Where patching occurs in a painted surface, prepare substrate and apply primer and intermediate paint coats appropriate for substrate over the patch, and apply final paint coat over entire unbroken surface containing the patch. Provide additional coats until patch blends with adjacent surfaces.
- (4) Ceilings: Patch, repair, or rehang in-place ceilings as necessary to provide an even- plane surface of uniform appearance.
- (5) Exterior Building Enclosure: Patch components in a manner that restores enclosure to a weathertight condition and ensures thermal and moisture integrity of building enclosure.
- I. Cleaning: Clean areas and spaces where cutting and patching are performed. Remove paint, mortar, oils, putty, and similar materials from adjacent finished surfaces.

### **3.07 OWNER-INSTALLED PRODUCTS**

- A. Site Access: Provide access to Project site for Owner's construction personnel.
- B. Coordination: Coordinate construction and operations of the Work with work performed by Owner's construction personnel.
  - (1) Construction Schedule: Inform Owner of Contractor's preferred construction schedule for Owner's portion of the Work. Adjust construction schedule based on a mutually agreeable timetable. Notify Owner if changes to schedule are required due to differences in actual construction progress.
  - (2) Preinstallation Conferences: Include Owner's construction personnel at preinstallation conferences covering portions of the Work that are to receive Owner's work. Attend preinstallation conferences conducted by Owner's construction personnel if portions of the Work depend on Owner's construction.

### **3.08 PROGRESS CLEANING**

- A. General: Clean Project site and work areas daily, including common areas. Enforce requirements strictly. Dispose of materials lawfully.
  - (1) Comply with requirements in NFPA 241 for removal of combustible waste materials and debris.
  - 2. Do not hold waste materials more than seven days during normal weather or three days if the temperature is expected to rise above 80 deg F.

3. Containerize hazardous and unsanitary waste materials separately from other waste. Mark containers appropriately and dispose of legally, according to regulations.
  - (a) Use containers intended for holding waste materials of type to be stored.
- (3) Coordinate progress cleaning for joint-use areas where Contractor and other contractors are working concurrently.
- B. Site: Maintain Project site free of waste materials and debris.
- C. Work Areas: Clean areas where work is in progress to the level of cleanliness necessary for proper execution of the Work.
  - (1) Remove liquid spills promptly.
  - (2) Where dust would impair proper execution of the Work, broom-clean or vacuum the entire work area, as appropriate.
- D. Installed Work: Keep installed work clean. Clean installed surfaces according to written instructions of manufacturer or fabricator of product installed, using only cleaning materials specifically recommended. If specific cleaning materials are not recommended, use cleaning materials that are not hazardous to health or property and that will not damage exposed surfaces.
- E. Concealed Spaces: Remove debris from concealed spaces before enclosing the space.
- F. Exposed Surfaces in Finished Areas: Clean exposed surfaces and protect as necessary to ensure freedom from damage and deterioration at time of Substantial Completion.
- G. Waste Disposal: Do not bury or burn waste materials on-site. Do not wash waste materials down sewers or into waterways. Comply with waste disposal requirements in Section 01 50 13 "Construction Waste Management and Disposal."
- H. During handling and installation, clean and protect construction in progress and adjoining materials already in place. Apply protective covering where required to ensure protection from damage or deterioration at Substantial Completion.
- I. Clean and provide maintenance on completed construction as frequently as necessary through the remainder of the construction period. Adjust and lubricate operable components to ensure operability without damaging effects.

- J. Limiting Exposures: Supervise construction operations to assure that no part of the construction, completed or in progress, is subject to harmful, dangerous, damaging, or otherwise deleterious exposure during the construction period.

### **3.09 STARTING AND ADJUSTING**

- A. Start equipment and operating components to confirm proper operation. Remove malfunctioning units, replace with new units, and retest.
- B. Adjust equipment for proper operation. Adjust operating components for proper operation without binding.
- C. Test each piece of equipment to verify proper operation. Test and adjust controls and safeties. Replace damaged and malfunctioning controls and equipment.
- D. Manufacturer's Field Service: Comply with qualification requirements in Section 01 40 00 "Quality Requirements."

### **3.10 PROTECTION OF INSTALLED CONSTRUCTION**

- A. Provide final protection and maintain conditions that ensure installed Work is without damage or deterioration at time of Substantial Completion.
- B. Comply with manufacturer's written instructions for temperature and relative humidity.

END OF SECTION

## CUTTING AND PATCHING

### PART 1 – GENERAL

#### 1.01 RELATED DOCUMENTS AND PROVISIONS:

All Contract Documents should be reviewed for applicable provisions related to the provisions in this document, including without limitation:

- A. General Conditions 3.12; and
- B. Agreement.

#### 1.02 CUTTING AND PATCHING:

- A. Contractor shall be responsible for all cutting, fitting, and patching, including associated excavation and backfill, required to complete the Work or to:
  - (1) Make several parts fit together properly.
  - (2) Uncover portions of Work to provide for installation of ill-timed Work.
  - (3) Remove and replace defective Work.
  - (4) Remove and replace Work not conforming to requirements of Contract Documents.
  - (5) Remove Samples of installed Work as specified for testing.
  - (6) Provide routine penetrations of non-structural surfaces for installation of piping and electrical conduit.
  - (7) Attach new materials to existing remodeling areas – including painting (or other finishes) to match existing conditions.
- B. In addition to Contract requirements, upon written instructions from the Owner, Contractor shall uncover Work to provide for observations of covered Work in accordance with the Contract Documents; remove samples of installed materials for testing as directed by Owner; and remove Work to provide for alteration of existing Work.
- C. Contractor shall not cut or alter Work, or any part of it, in such a way that endangers or compromises the integrity of the Work, the Project, or work of others.

### 1.03 SUBMITTALS:

- A. Prior to any cutting or alterations that may affect the structural safety of Project, or work of others, and well in advance of executing such cutting or alterations, Contractor shall submit written notice to Owner pursuant to the applicable notice provisions of the Contract Documents, requesting consent to proceed with the cutting or alteration, including the following:
- (1) The work of the Owner or other trades.
  - (2) Structural value or integrity of any element of Project.
  - (3) Integrity or effectiveness of weather-exposed or weather-resistant elements or systems.
  - (4) Efficiency, operational life, maintenance or safety of operational elements.
  - (5) Visual qualities of sight-exposed elements.
- B. Contractor's Request shall also include:
- (1) Identification of Project.
  - (2) Description of affected Work.
  - (3) Necessity for cutting, alteration, or excavations.
  - (4) Affects of Work on Owner, other trades, or structural or weatherproof integrity of Project.
  - (5) Description of proposed Work:
    - (a) Scope of cutting, patching, alteration, or excavation.
    - (b) Trades that will execute Work.
    - (c) Products proposed to be used.
    - (d) Extent of refinishing to be done.
  - (6) Alternates to cutting and patching.
  - (7) Cost proposal, when applicable.
  - (8) The scheduled date the Contractor intends to perform the Work and the duration of time to complete the Work.
  - (9) Written permission of other trades whose Work will be affected.

#### **1.04 QUALITY ASSURANCE:**

- A. Contractor shall ensure that cutting, fitting, and patching shall achieve security, strength, weather protection, appearance for aesthetic match, efficiency, operational life, maintenance, safety of operational elements, and the continuity of existing fire ratings.
- B. Contractor shall ensure that cutting, fitting, and patching shall successfully duplicate undisturbed adjacent profiles, materials, textures, finishes, colors, and that materials shall match existing construction. Where there is dispute as to whether duplication is successful or has been achieved to a reasonable degree, the Owner's decision shall be final.

#### **1.05 PAYMENT FOR COSTS:**

- A. Cost caused by ill-timed or defective Work or Work not conforming to Contract Documents, including costs for additional services of the Owner, its consultants, including but not limited to the Construction Manager, the Architect, the Project Inspector(s), Engineers, and Agents, will be paid by Contractor and/or deducted from the Contract by the Owner.
- B. Owner shall only pay for cost of Work if it is part of the original Contract Price or if a change has been made to the contract in compliance with the provisions of the General Conditions. Cost of Work performed upon instructions from the Owner, other than defective or nonconforming Work, will be paid by Owner on approval of written Change Order. Contractor shall provide written cost proposals prior to proceeding with cutting and patching.

### **PART 2 - PRODUCTS**

#### **2.01 MATERIALS:**

- A. Contractor shall provide for replacement and restoration of Work removed. Contractor shall comply with the Contract Documents and with the Industry Standard(s), for the type of Work, and the Specification requirements for each specific product involved. If not specified, Contractor shall first recommend a product of a manufacturer or appropriate trade association for approval by the Owner.
- B. Materials to be cut and patched include those damaged by the performance of the Work.

### **PART 3 – EXECUTION**

#### **3.01 INSPECTION:**

- A. Contractor shall inspect existing conditions of the Site and the Work, including elements subject to movement or damage during cutting and patching, excavating

and backfilling. After uncovering Work, Contractor shall inspect conditions affecting installation of new products.

- B. Contractor shall report unsatisfactory or questionable conditions in writing to Owner as indicated in the General Conditions and shall proceed with Work as indicated in the General Conditions by Owner.

### **3.02 PREPARATION:**

- A. Contractor shall provide shoring, bracing and supports as required to maintain structural integrity for all portions of the Project, including all requirements of the Project.
- B. Contractor shall provide devices and methods to protect other portions of Project from damage.
- C. Contractor shall, provide all necessary protection from weather and extremes of temperature and humidity for the Project, including without limitation, any work that may be exposed by cutting and patching Work. Contractor shall keep excavations free from water.

### **3.03 ERECTION, INSTALLATION AND APPLICATION:**

- A. With respect to performance, Contractor shall:
  - (1) Execute fitting and adjustment of products to provide finished installation to comply with and match specified tolerances and finishes.
  - (2) Execute cutting and demolition by methods that will prevent damage to other Work, and provide proper surfaces to receive installation of repairs and new Work.
  - (3) Execute cutting, demolition excavating, and backfilling by methods that will prevent damage to other Work and damage from settlement.
- B. Contractor shall employ original installer or fabricator to perform cutting and patching for:
  - (1) Weather-exposed surfaces and moisture-resistant elements such as roofing, sheet metal, sealants, waterproofing, and other trades.
  - (2) Sight-exposed finished surfaces.
- C. Contractor shall execute fitting and adjustment of products to provide a finished installation to comply with specified products, functions, tolerances, and finishes as shown or specified in the Contract Documents including, without limitation, the Drawings and Specifications.



- D. Contractor shall fit Work airtight to pipes, sleeves, ducts, conduit, and other penetrations through surfaces. Contractor shall conform to all Code requirements for penetrations or the Drawings and Specifications, whichever calls for a higher quality or more thorough requirement. Contractor shall maintain integrity of both rated and non-rated fire walls, ceilings, floors, etc.
- E. Contractor shall restore Work which has been cut or removed. Contractor shall install new products to provide completed Work in accordance with requirements of the Contract Documents and as required to match surrounding areas and surfaces.
- F. Contractor shall refinish all continuous surfaces to nearest intersection as necessary to match the existing finish to any new finish.

END OF SECTION

## **ALTERATION PROJECT PROCEDURES**

### **PART 1 – GENERAL**

#### **1.01 RELATED DOCUMENTS AND PROVISIONS:**

All Contract Documents should be reviewed for applicable provisions related to the provisions in this document, including without limitation:

- A. General Conditions; and
- B. Agreement.

### **PART 2 - PRODUCTS**

#### **2.01 PRODUCTS FOR PATCHING AND EXTENDING WORK:**

- A. New Materials: As specified in the Contract Documents including, without limitation, in the Specifications, Contractor shall match existing products, conditions, and work for patching and extending work.
- B. Type and Quality of Existing Products: Contractor shall determine by inspection, by testing products where necessary, by referring to existing conditions and to the Work as a standard.

### **PART 3 - EXECUTION**

#### **3.01 EXAMINATION:**

- A. Contractor shall verify that demolition is complete and that areas are ready for installation of new Work.
- B. By beginning restoration Work, Contractor acknowledges and accepts the existing conditions.

#### **3.02 PREPARATION:**

- A. Contractor shall cut, move, or remove items as necessary for access to alterations and renovation Work. Contractor shall replace and restore these at completion.
- B. Contractor shall remove unsuitable material not as salvage unless otherwise indicated in the Contract Documents. Unsuitable material may include, without limitation, rotted wood, corroded metals, and deteriorated masonry and concrete. Contractor shall replace materials as specified for finished Work.
- C. Contractor shall remove debris and abandoned items from all areas of the Site and from concealed spaces.

- D. Contractor shall prepare surface and remove surface finishes to provide for proper installation of new Work and finishes.
- E. Contractor shall close openings in exterior surfaces to protect existing work from weather and extremes of temperature and humidity. Contractor shall insulate ductwork and piping to prevent condensation in exposed areas. Contractor shall insulate building cavities for thermal and/or acoustical protection, as detailed.

### **3.03 INSTALLATION:**

- A. Contractor shall coordinate Work of all alternations and renovations to expedite completion and to accommodate Owner occupancy.
- B. Designated Areas and Finishes: Contractor shall complete all installations in all respects, including operational, mechanical work and electrical work.
- C. Contractor shall remove, cut, and patch Work in a manner to minimize damage and to provide a means of restoring Products and finishes to original or specified condition.
- D. Contractor shall refinish visible existing surfaces to remain in renovated rooms and spaces, to specified condition for each material, with a neat transition to adjacent finishes.
- E. Contractor shall install products as specified in the Contract Documents, including without limitation, the Specifications.

### **3.04 TRANSITIONS:**

- A. Where new Work abuts or aligns with existing, Contractor shall perform a smooth and even transition. Patched Work must match existing adjacent work in texture and appearance.
- B. When finished surfaces are cut so that a smooth transition with new Work is not possible, Contractor shall terminate existing surface along a straight line at a natural line of division and make a recommendation for resolution to the Owner and the Architect for review and approval.

### **3.05 ADJUSTMENTS:**

- A. Where removal of partitions or walls results in adjacent spaces becoming one, Contractor shall rework floors, walls, and ceilings to a smooth plane without breaks, steps, or bulkheads.
- B. Where a change of plane of 1/4 inch or more occurs, Contractor shall submit a recommendation for providing a smooth transition to the Owner and the Architect for review and approval.

- C. Contractor shall trim existing doors as necessary to clear new floor finish and refinish trim as required.
- D. Contractor shall fit Work at penetrations of surfaces.

**3.06 REPAIR OF DAMAGED SURFACES:**

- A. Contractor shall patch or replace portions of existing surfaces which are damaged, lifted, discolored, or showing other imperfections.
- B. Contractor shall repair substrate prior to patching finish.

**3.07 CULTIVATED AREAS AND OTHER SURFACE IMPROVEMENTS:**

- A. Cultivated or planted areas and other surface improvements which are damaged by actions of the Contractor shall be restored by Contractor to their original condition or better, where indicated.
- B. Contractor shall protect and replace, if damaged, all existing guard posts, barricades, and fences.
- C. Contractor shall give special attention to avoid damaging or killing trees, bushes and/or shrubs on the Premises and/or identified in the Contract Documents, including without limitation, the Drawings.

**3.08 FINISHES:**

- A. Contractor shall finish surfaces as specified in the Contract Documents, including without limitations, the provisions of all Divisions of the Specifications.
- B. Contractor shall finish patches to produce uniform finish and texture over entire area. When finish cannot be matched, Contractor shall refinish entire surface to nearest intersections.

**3.09 CLEANING:**

- A. Contractor shall continually clean the Site and the Premises as indicated in the Contract Documents, including without limitation, the provisions in the General Conditions and the Specifications regarding cleaning.

END OF SECTION

## **OPERATIONS AND MAINTENANCE DATA**

### **PART 1 – GENERAL**

#### **1.01 RELATED DOCUMENTS AND PROVISIONS:**

All Contract Documents should be reviewed for applicable provisions related to the provisions in this document, including without limitation:

- A. General Conditions; and
- B. Agreement.

#### **1.02 QUALITY ASSURANCE:**

Contractor shall prepare instructions and data by personnel experienced in maintenance and operation of described products.

#### **1.03 FORMAT:**

- A. Contractor shall prepare data in the form of an instructional manual entitled “OPERATIONS AND MAINTENANCE MANUAL & INSTRUCTIONS” (“Manual”).
- B. Binders: Contractor shall use commercial quality, 8-1/2 by 11 inch, three-side rings, with durable plastic covers; two inch maximum ring size. When multiple binders are used, Contractor shall correlate data into related consistent groupings.
- C. Cover: Contractor shall identify each binder with typed or printed title "OPERATION AND MAINTENANCE MANUAL & INSTRUCTIONS"; and shall list title of Project and identify subject matter of contents.
- D. Contractor shall arrange content by systems process flow under section numbers and sequence of Table of Contents of the Contract Documents.
- E. Contractor shall provide tabbed fly leaf for each separate product and system, with typed description of product and major component parts of equipment.
- F. Text: The content shall include Manufacturer's printed data, or typewritten data on 24 pound paper.
- G. Drawings: Contractor shall provide with reinforced punched binder tab and shall bind in with text; folding larger drawings to size of text pages.

#### **1.04 CONTENTS, EACH VOLUME:**

- A. Table of Contents: Contractor shall provide title of Project; names, addresses, and telephone numbers of the Architect, any engineers, subconsultants, Subcontractor(s), and Contractor with name of responsible parties; and schedule of products and systems, indexed to content of the volume.
- B. For Each Product or System: Contractor shall list names, addresses, and telephone numbers of Subcontractor(s) and suppliers, including local source of supplies and replacement parts.
- C. Product Data: Contractor shall mark each sheet to clearly identify specific products and component parts, and data applicable to installation. Delete inapplicable information.
- D. Drawings: Contractor shall supplement product data to illustrate relations of component parts of equipment and systems, to show control and flow diagrams. Contractor shall not use Project Record Documents as maintenance drawings.
- E. Text: The Contractor shall include any and all information as required to supplement product data. Contractor shall provide logical sequence of instructions for each procedure, incorporating manufacturer's instructions.
- F. Warranties and Bonds: Contractor shall bind in one copy of each.

#### **1.05 MANUAL FOR MATERIALS AND FINISHES:**

- A. Building Products, Applied Materials, and Finishes: Contractor shall include product data, with catalog number, size, composition, and color and texture designations. Contractor shall provide information for re-ordering custom manufactured products.
- B. Instructions for Care and Maintenance: Contractor shall include Manufacturer's recommendations for cleaning agents and methods, precautions against detrimental agents and methods, and recommended schedule for cleaning and maintenance.
- C. Moisture Protection and Weather Exposed Products: Contractor shall include product data listing applicable reference standards, chemical composition, and details of installation. Contractor shall provide recommendations for inspections, maintenance, and repair.
- D. Additional Requirements: Contractor shall include all additional requirements as specified in the Specifications.
- E. Contractor shall provide a listing in Table of Contents for design data, with tabbed fly sheet and space for insertion of data.

## 1.06 MANUAL FOR EQUIPMENT AND SYSTEMS:

- A. Each Item of Equipment and Each System: Contractor shall include description of unit or system, and component parts and identify function, normal operating characteristics, and limiting conditions. Contractor shall include performance curves, with engineering data and tests, and complete nomenclature, and commercial number of replaceable parts.
- B. Panelboard Circuit Directories: Contractor shall provide electrical service characteristics, controls, and communications.
- C. Contractor shall include color coded wiring diagrams as installed.
- D. Operating Procedures: Contractor shall include start-up, break-in, and routine normal operating instructions and sequences. Contractor shall include regulation, control, stopping, shut-down, and emergency instructions. Contractor shall include summer, winter, and any special operating instructions.
- E. Maintenance Requirements: Contractor shall include routine procedures and guide for trouble-shooting; disassembly, repair, and reassembly instructions; and alignment, adjusting, balancing, and checking instructions.
- F. Contractor shall provide servicing and lubrication schedule, and list of lubricants required.
- G. Contractor shall include manufacturer's printed operation and maintenance instructions.
- H. Contractor shall include sequence of operation by controls manufacturer.
- I. Contractor shall provide original manufacturer's parts list, illustrations, assembly drawings, and diagrams required for maintenance.
- J. Contractor shall provide control diagrams by controls manufacturer as installed.
- K. Contractor shall provide Contractor's coordination drawings, with color coded piping diagrams as installed.
- L. Contractor shall provide charts of valve tag numbers, with location and function of each valve, keyed to flow and control diagrams.
- M. Contractor shall provide list of original manufacturer's spare parts, current prices, and recommended quantities to be maintained in storage.
- N. Additional Requirements: Contractor shall include all additional requirements as specified in Specification(s).

- O. Contractor shall provide a listing in Table of Contents for design data, with tabbed fly sheet and space for insertion of data.

**1.07 SUBMITTAL:**

- A. Contractor shall submit to the Owner for review three (3) copies of preliminary draft or proposed formats and outlines of the contents of the Manual within thirty (30) days of Contractor's start of Work.
- B. For equipment, or component parts of equipment put into service during construction and to be operated by Owner, Contractor shall submit draft content for that portion of the Manual within ten (10) days after acceptance of that equipment or component.
- C. Contractor shall submit three (3) copies of a complete Manual in final form prior to final Application for Payment. Copy will be returned with Architect/Engineer comments. Contractor must revise the content of the Manual as required by Owner prior to Owner's approval of Contractor's final Application for Payment.
- D. Contractor must submit three (3) copies of revised Manual in final form within ten (10) days after final inspection.

**PART 2 – PRODUCTS (Not Used)**

**PART 3 – EXECUTION (Not Used)**

END OF SECTION



## **WARRANTIES**

### **PART 1 - GENERAL**

#### **1.01 RELATED DOCUMENTS AND PROVISIONS**

All Contract Documents should be reviewed for applicable provisions related to the provisions in this document, including without limitation:

- A. General Conditions §§ 3.5, 9.7.1, and 12.2.5; and
- B. Agreement.

#### **1.02 FORMAT**

- A. Binders: Contractor shall use commercial quality, 8-1/2 by 11 inch, three-side rings, with durable plastic covers; two inch maximum ring size.
- B. Cover: Contractor shall identify each binder with typed or printed title "WARRANTIES" and shall list title of Project.
- C. Table of Contents: Contractor shall provide title of Project; name, address, and telephone number of Contractor and equipment supplier, and name of responsible principal. Contractor shall identify each item with the number and title of the specific Specification, document, provision, or section in which the name of the product or work item is specified.
- D. Contractor shall separate each warranty with index tab sheets keyed to the Table of Contents listing, providing full information and using separate typed sheets as necessary. Contractor shall list each applicable and/or responsible Subcontractor(s), supplier(s), and/or manufacturer(s), with name, address, and telephone number of each responsible principal(s).

#### **1.03 PREPARATION:**

- A. Contractor shall obtain warranties, executed in duplicate by each applicable and/or responsible subcontractor(s), supplier(s), and manufacturer(s), within ten (10) days after completion of the applicable item or work. Except for items put into use with Owner's permission, Contractor shall leave date of beginning of time of warranty until the date of completion is determined.
- B. Contractor shall verify that documents are in proper form, contain full information, and are notarized, when required.
- C. Contractor shall co-execute submittals when required.
- D. Contractor shall retain warranties until time specified for submittal.

**1.04 TIME OF SUBMITTALS:**

- A. For equipment or component parts of equipment put into service during construction with Owner's permission, Contractor shall submit a draft warranty for that equipment or component within ten (10) days after acceptance of that equipment or component.
- B. Contractor shall submit for Owner approval all warranties and related documents within ten (10) days after date of completion. Contractor must revise the warranties as required by the Owner prior to Owner's approval of Contractor's final Application for Payment.
- C. For items of work delayed beyond date of completion, provide updated submittal within ten days after acceptance, listing the date of acceptance as start of warranty period.

**PART 2 - PRODUCTS (Not Used)**

**PART 3 – EXECUTION (Not Used)**

END OF SECTION

## **RECORD DOCUMENTS**

### **PART 1 - GENERAL**

#### **1.01 RELATED DOCUMENTS AND PROVISIONS:**

All Contract Documents should be reviewed for applicable provisions related to the provisions in this document, including without limitation:

- A. General Conditions § 9.9.2; and
- B. Agreement.

### **PART 2 PART 2 - RECORD DRAWINGS**

#### **2.01 GENERAL:**

- A. As indicated in the Contract Documents, the Owner will provide Contractor with one set of reproducible (mylars) plans of the original Contract Drawings.
- B. Contractor shall maintain at each Project Site one set of marked-up plans and shall transfer all changes and information to those marked-up plans, as often as required in the Contract Documents, but in no case less than once each month. Contractor shall submit to the Project Inspector one set of reproducible vellums of the Project Record Drawings ("As-Builts") showing all changes incorporated into the Work since the preceding monthly submittal. The As-Builts shall be available at the Project Site. The Contractor shall submit reproducible vellums at the conclusion of the Project following review of the blue-line prints.
- C. Label and date each Record Drawing "RECORD DOCUMENT" in legibly printed letters.
- D. All deviations in construction, including but not limited to pipe and conduit locations and deviations caused by without limitation Change Orders, Construction Claim Directives, RFI's, and Addenda, shall be accurately and legibly recorded by Contractor.
- E. Locations and changes shall be done by Contractor in a neat and legible manner and, where applicable, indicated by drawing a "cloud" around the changed or additional information.

#### **2.02 RECORD DRAWING INFORMATION:**

- A. Contractor shall record the following information:
  - (1) Locations of Work buried under or outside each building, including, without limitation, all utilities, plumbing and electrical lines, and conduits.

- (2) Actual numbering of each electrical circuit.
- (3) Locations of significant Work concealed inside each building whose general locations are changed from those shown on the Contract Drawings.
- (4) Locations of all items, not necessarily concealed, which vary from the Contract Documents.
- (5) Installed location of all cathodic protection anodes.
- (6) Deviations from the sizes, locations, and other features of installations shown in the Contract Documents.
- (7) Locations of underground work, points of connection with existing utilities, changes in direction, valves, manholes, catch basins, capped stubouts, invert elevations, etc.
- (8) Sufficient information to locate Work concealed in each building with reasonable ease and accuracy.

In some instances, this information may be recorded by dimension. In other instances, it may be recorded in relation to the spaces in the building near which it was installed.

- B. Contractor shall provide additional drawings as necessary for clarification.
- C. Contractor shall provide reproducible record drawings, made from final Shop Drawings marked "No Exceptions Taken" or "Approved as Noted."

### **PART 3 - RECORD SPECIFICATIONS**

#### **3.01 GENERAL:**

Contractor shall mark each section legibly to record manufacturer, trade name, catalog number, and supplier of each Product and item of equipment actually installed.

### **PART 4 - MAINTENANCE OF RECORD DOCUMENTS**

#### **4.01 GENERAL**

- A. Contractor shall store Record Documents apart from documents used for construction as follows:
  - (1) Provide files and racks for storage of Record Documents.
  - (2) Maintain Record Documents in a clean, dry, legible condition and in good order.
- B. Do not use Record Documents for construction purposes.

**PART 5 – PRODUCTS (Not Used)**

END OF SECTION

## **DEMONSTRATION AND TRAINING**

### **PART 1 - GENERAL**

#### **1.01 RELATED DOCUMENTS:**

- A. Drawings and general provisions of the Contract, including General Conditions and other Division 01 Specification Sections, apply to this Section.

#### **1.02 SUMMARY:**

- A. Section includes administrative and procedural requirements for instructing Owner's personnel, including the following:
  - (1) Demonstration of operation of systems, subsystems, and equipment.
  - (2) Training in operation and maintenance of systems, subsystems, and equipment.
  - (3) Demonstration and training video recordings.
- B. Allowances: Furnish demonstration and training instruction time under the Demonstration and Training Allowance as specified in Section 01 21 00 "Allowances."
- C. Unit Price for Instruction Time: Length of instruction time will be measured by actual time spent performing demonstration and training in required location. No payment will be made for time spent assembling educational materials, setting up, or cleaning up. See requirements in Section 01 22 00 "Alternatives and Unit Pricing."

#### **1.03 INFORMATIONAL SUBMITTALS:**

- A. Instruction Program: Submit outline of instructional program for demonstration and training, including a list of training modules and a schedule of proposed dates, times, length of instruction time, and instructors' names for each training module. Include learning objective and outline for each training module.
  - (1) Indicate proposed training modules using manufacturer-produced demonstration and training video recordings for systems, equipment, and products in lieu of video recording of live instructional module.
- B. Qualification Data: For instructor.

- C. Attendance Record: For each training module, submit list of participants and length of instruction time.
- D. Evaluations: For each participant and for each training module, submit results and documentation of performance-based test.

#### **1.04 CLOSEOUT SUBMITTALS:**

- A. Demonstration and Training Video Recordings: Submit two copies within seven days of end of each training module.
  - (1) Identification: On each copy, provide an applied label with the following information:
    - (a) Name of Project.
    - (b) Name and address of videographer.
    - (c) Name of Architect.
    - (d) Name of Construction Manager.
    - (e) Name of Contractor.
    - (f) Date of video recording.
  - (2) Transcript: Prepared and bound in format matching operation and maintenance manuals. Mark appropriate identification on front and spine of each binder. Include a cover sheet with same label information as the corresponding video recording. Include name of Project and date of video recording on each page.
  - (3) Transcript: Prepared in PDF electronic format. Include a cover sheet with same label information as the corresponding video recording and a table of contents with links to corresponding training components. Include name of Project and date of video recording on each page.

- (4) At completion of training, submit complete training manual(s) for Owner's use prepared and bound in format matching operation and maintenance manuals and in PDF electronic file format on compact disc.

#### **1.05 QUALITY ASSURANCE:**

- A. Facilitator Qualifications: A firm or individual experienced in training or educating maintenance personnel in a training program similar in content and extent to that indicated for this Project, and whose work has resulted in training or education with a record of successful learning performance.
  - B. Instructor Qualifications: A factory-authorized service representative, complying with requirements in Section 01 40 00 "Quality Requirements," experienced in operation and maintenance procedures and training.
  - C. Videographer Qualifications: A professional videographer who is experienced photographing demonstration and training events similar to those required.
  - D. Preinstruction Conference: Conduct conference at Project site to comply with requirements in Section 01 31 00 "Project Management and Coordination." Review methods and procedures related to demonstration and training including, but not limited to, the following:
    - (1) Inspect and discuss locations and other facilities required for instruction.
    2. Review and finalize instruction schedule and verify availability of educational materials, instructors' personnel, audiovisual equipment, and facilities needed to avoid delays.
- (5) Review required content of instruction.
  - (6) For instruction that must occur outside, review weather and forecasted weather conditions and procedures to follow if conditions are unfavorable.

#### **1.06 COORDINATION**

- A. Coordinate instruction schedule with Owner's operations. Adjust schedule as required to minimize disrupting Owner's operations and to ensure availability of Owner's personnel.
- B. Coordinate instructors, including providing notification of dates, times, length of instruction time, and course content.



- C. Coordinate content of training modules with content of approved emergency, operation, and maintenance manuals. Do not submit instruction program until operation and maintenance data has been reviewed and approved by Architect.

## **PART 2 – PRODUCTS**

### **2.01 INSTRUCTIONAL PROGRAM**

- A. Program Structure: Develop an instruction program that includes individual training modules for each system and for equipment not part of a system, as required by individual Specification Sections.
- B. Training Modules: Develop a learning objective and teaching outline for each module. Include a description of specific skills and knowledge that participant is expected to master. For each module, include instruction for the following as applicable to the system, equipment, or component:

7. Basis of System Design, Operational Requirements, and Criteria: Include the following:

- (a) System, subsystem, and equipment descriptions.
  - (b) Performance and design criteria if Contractor is delegated design responsibility.
  - (c) Operating standards.
  - (d) Regulatory requirements.
  - (e) Equipment function.
  - (f) Operating characteristics.
  - (g) Limiting conditions.
  - (h) Performance curves.
- (7) Documentation: Review the following items in detail:

- (a) Emergency manuals.
  - (b) Operations manuals.
  - (c) Maintenance manuals.
  - (d) Project record documents.
  - (e) Identification systems.
  - (f) Warranties and bonds.
  - (g) Maintenance service agreements and similar continuing commitments.
- (8) Emergencies: Include the following, as applicable:
- (a) Instructions on meaning of warnings, trouble indications, and error messages.
  - (b) Instructions on stopping.
  - (c) Shutdown instructions for each type of emergency.
  - (d) Operating instructions for conditions outside of normal operating limits.
  - (e) Sequences for electric or electronic systems.
  - (f) Special operating instructions and procedures.
- (9) Operations: Include the following, as applicable:

- (a) Startup procedures.
- (b) Equipment or system break-in procedures.
- (c) Routine and normal operating instructions.
- (d) Regulation and control procedures.
- (e) Control sequences.
- (f) Safety procedures.
- (g) Instructions on stopping.
- (h) Normal shutdown instructions.
- (i) Operating procedures for emergencies.
- (j) Operating procedures for system, subsystem, or equipment failure.
- (k) Seasonal and weekend operating instructions.
- (l) Required sequences for electric or electronic systems.
- (m) Special operating instructions and procedures.

(10) Adjustments: Include the following:

- (a) Alignments.
- (b) Checking adjustments.

(c) Noise and vibration adjustments.

(d) Economy and efficiency adjustments.

(11) Troubleshooting: Include the following:

(a) Diagnostic instructions.

(b) Test and inspection procedures.

(12) Maintenance: Include the following:

(a) Inspection procedures.

(b) Types of cleaning agents to be used and methods of cleaning.

(c) List of cleaning agents and methods of cleaning detrimental to product.

(d) Procedures for routine cleaning.

(e) Procedures for preventive maintenance.

(f) Procedures for routine maintenance.

(g) Instruction on use of special tools.

(13) Repairs: Include the following:

(a) Diagnosis instructions.

(b) Repair instructions.

- (c) Disassembly; component removal, repair, and replacement; and reassembly instructions.
- (d) Instructions for identifying parts and components.
- (e) Review of spare parts needed for operation and maintenance.

## **PART 3 – EXECUTION**

### **3.01 PREPARATION**

- A. Assemble educational materials necessary for instruction, including documentation and training module. Assemble training modules into a training manual organized in coordination with requirements in Section 01 78 23 "Operations and Maintenance Data."
- B. Set up instructional equipment at instruction location.

### **3.02 INSTRUCTION**

- A. Facilitator: Engage a qualified facilitator to prepare instruction program and training modules, to coordinate instructors, and to coordinate between Contractor and Owner for number of participants, instruction times, and location.
- B. Engage qualified instructors to instruct Owner's personnel to adjust, operate, and maintain systems, subsystems, and equipment not part of a system.
  - 8. Architect will furnish an instructor to describe basis of system design, operational requirements, criteria, and regulatory requirements.
  - 9. Owner will furnish an instructor to describe Owner's operational philosophy.
- (14) Owner will furnish Contractor with names and positions of participants.
- E. Scheduling: Provide instruction at mutually agreed on times. For equipment that requires seasonal operation, provide similar instruction at start of each season.
  - (1) Schedule training with Owner with at least seven days' advance notice.

- F. Training Location and Reference Material: Conduct training on-site in the completed and fully operational facility using the actual equipment in-place. Conduct training using final operation and maintenance data submittals.
- G. Evaluation: At conclusion of each training module, assess and document each participant's mastery of module by use of an oral or a written performance-based test.
- H. Cleanup: Collect used and leftover educational materials and remove from Project site. Remove instructional equipment. Restore systems and equipment to condition existing before initial training use.

## **1.02 DEMONSTRATION AND TRAINING VIDEO RECORDINGS**

- A. General: Engage a qualified commercial videographer to record demonstration and training video recordings. Record each training module separately. Include classroom instructions and demonstrations, board diagrams, and other visual aids, but not student practice.
  - (1) At beginning of each training module, record each chart containing learning objective and lesson outline.
- B. Video: Provide minimum 640 x 480 video resolution converted to format file type acceptable to Owner, on electronic media.
  - (1) Electronic Media: Read-only format compact disc acceptable to Owner, with commercial-grade graphic label.
  - (2) File Hierarchy: Organize folder structure and file locations according to project manual table of contents. Provide complete screen-based menu.
  - (3) File Names: Utilize file names based upon name of equipment generally described in video segment, as identified in Project specifications.
  - (4) Contractor and Installer Contact File: Using appropriate software, create a file for inclusion on the Equipment Demonstration and Training DVD that describes the following for each Contractor involved on the Project, arranged according to Project table of contents:

- (a) Name of Contractor/Installer.
  - (b) Business address.
  - (c) Business phone number.
  - (d) Point of contact.
  - (e) E-mail address.
- C. Recording: Mount camera on tripod before starting recording, unless otherwise necessary to adequately cover area of demonstration and training. Display continuous running time.
- (1) Film training session(s) in segments not to exceed 15 minutes.
    - (a) Produce segments to present a single significant piece of equipment per segment.
    - (b) Organize segments with multiple pieces of equipment to follow order of Project Manual table of contents.
    - (c) Where a training session on a particular piece of equipment exceeds 15 minutes, stop filming and pause training session. Begin training session again upon commencement of new filming segment.
- D. Light Levels: Verify light levels are adequate to properly light equipment. Verify equipment markings are clearly visible prior to recording.
- (1) Furnish additional portable lighting as required.
- E. Narration: Describe scenes on video recording by audio narration by microphone while dubbing audio narration off-site after video recording is recorded. Include description of items being viewed.

- F. Transcript: Provide a transcript of the narration. Display images and running time captured from videotape opposite the corresponding narration segment.
- G. Preproduced Video Recordings: Provide video recordings used as a component of training modules in same format as recordings of live training.

END OF SECTION



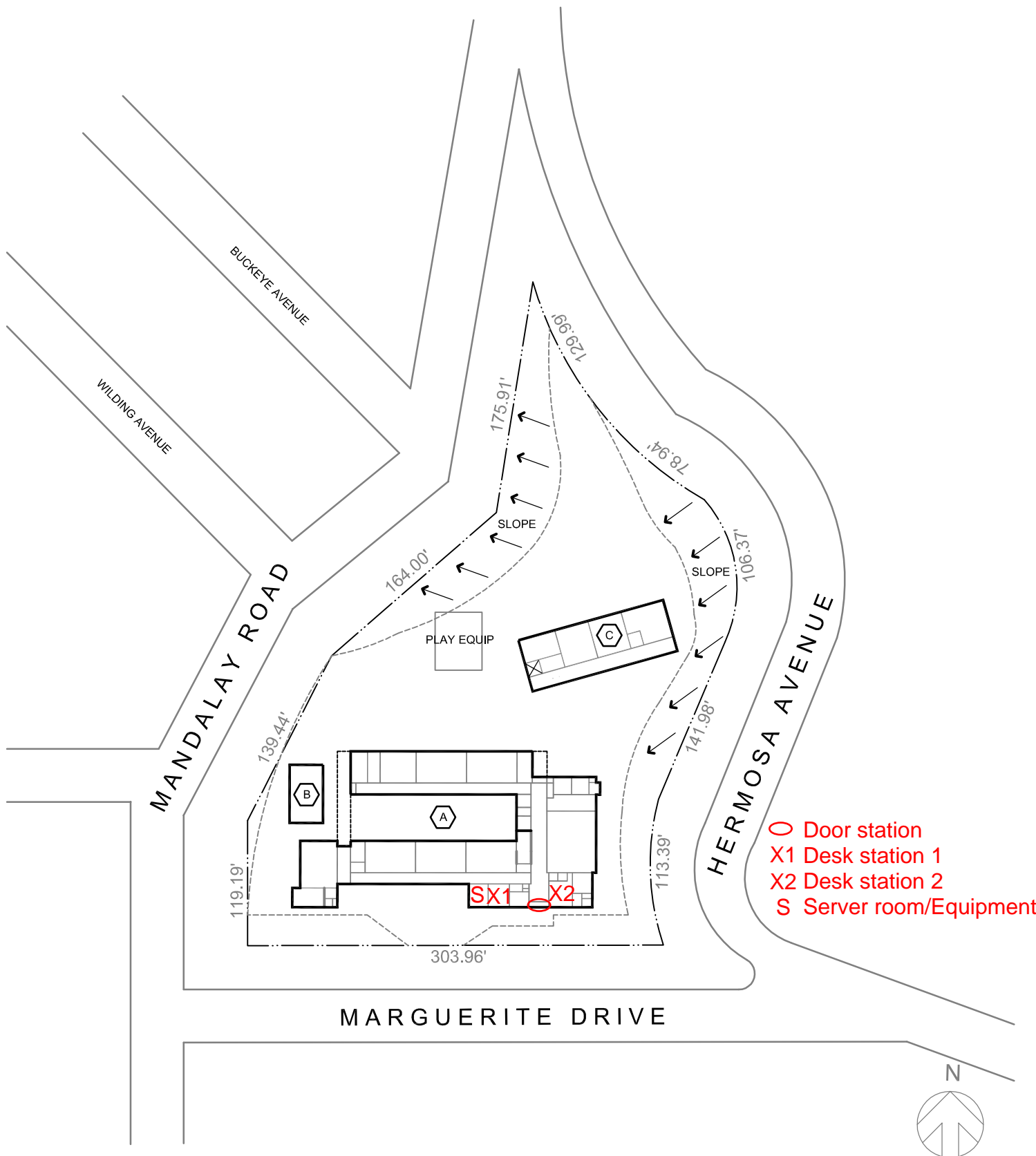

- Door station
- X1 Desk station 1
- X2 Desk station 2
- S Server room/Equipment

MARGUERITE DRIVE

SITE PLAN

127 - HILLCREST ELEMENTARY SCHOOL  
 30 MARGUERITE DRIVE, OAKLAND, CA 94618-2230



Date: 1/18/2013

Scale: 1"=100'-0"

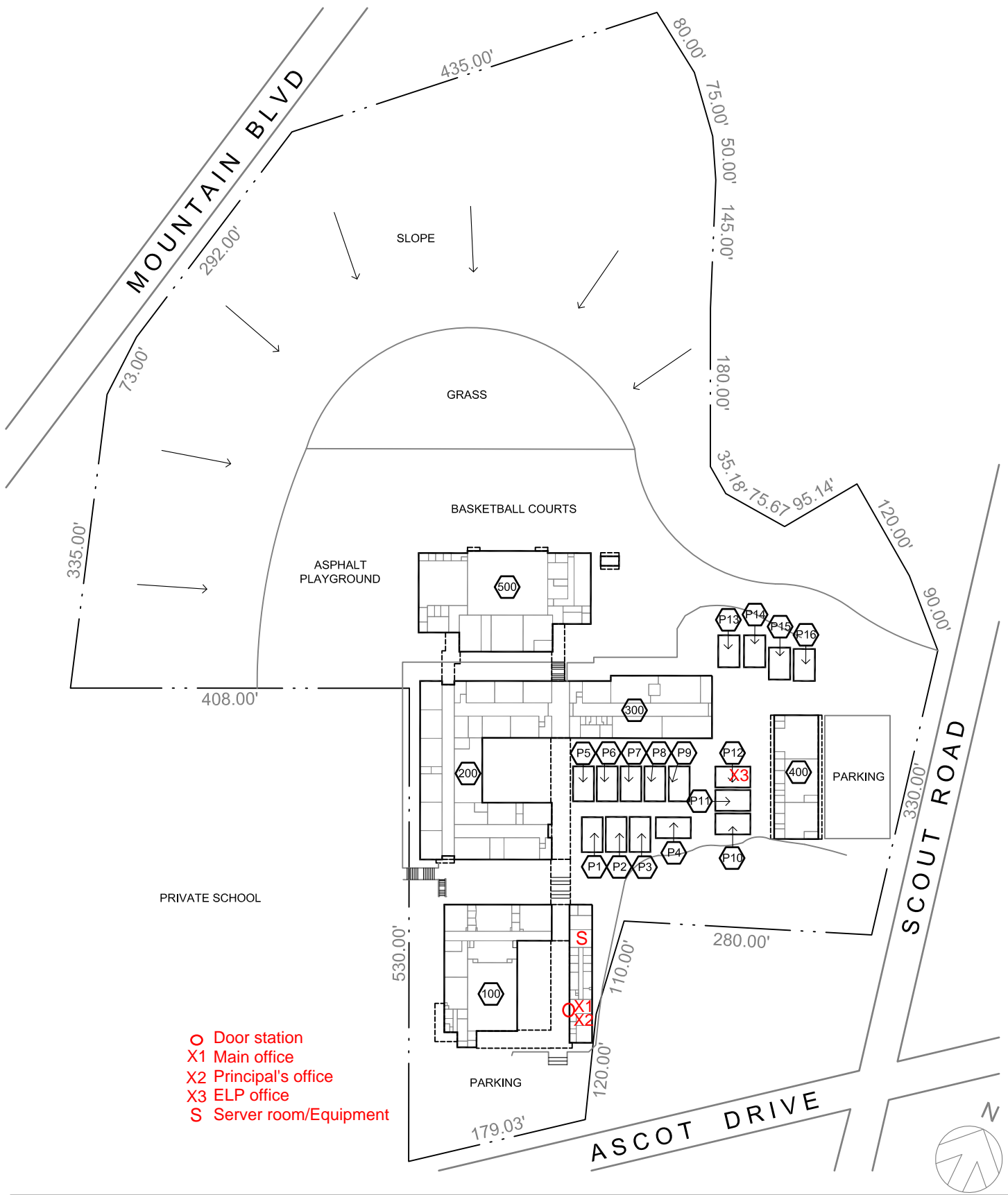

- Door station
- X1 Main office
- X2 Principal's office
- X3 ELP office
- S Server room/Equipment

**SITE PLAN**

**211 - MONTERIA MIDDLE SCHOOL**  
 5555 ASCOT DRIVE, OAKLAND, CA 94611-3001



Date: 1/18/2013

Scale: 1"=150'-0"

10TH AVENUE

EAST 24TH STREET

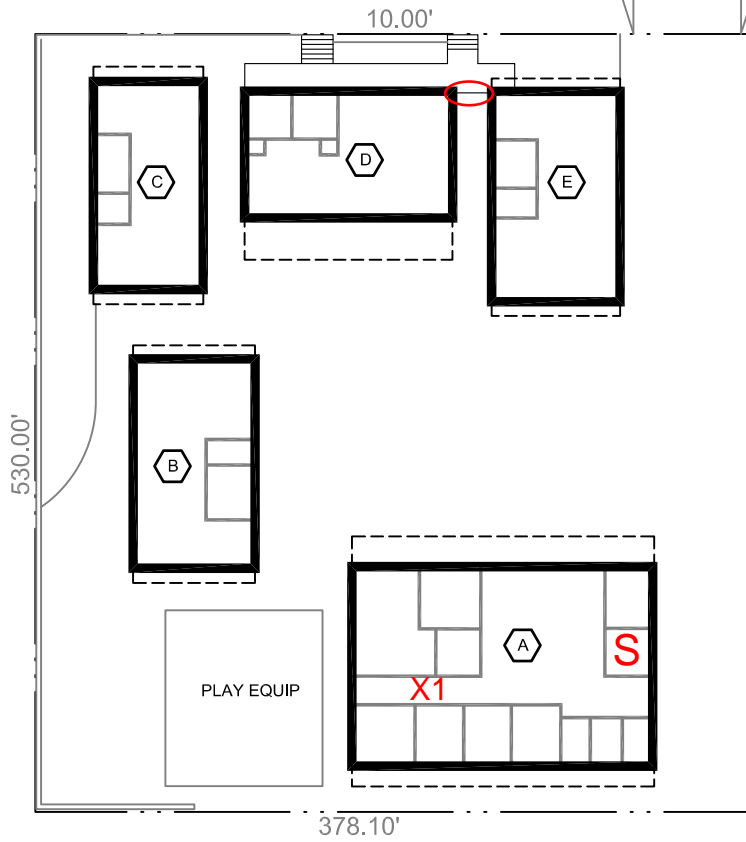

- Door station
- X1 Desk station
- S Server room/Equipment



SITE PLAN

805 - BELLA VISTA C.D.C.  
2410 10TH AVENUE, OAKLAND, CA 94606-2704



Date: 1/18/2013

Scale: 1"=40'-0"

SAN JUAN ST

MERA ST

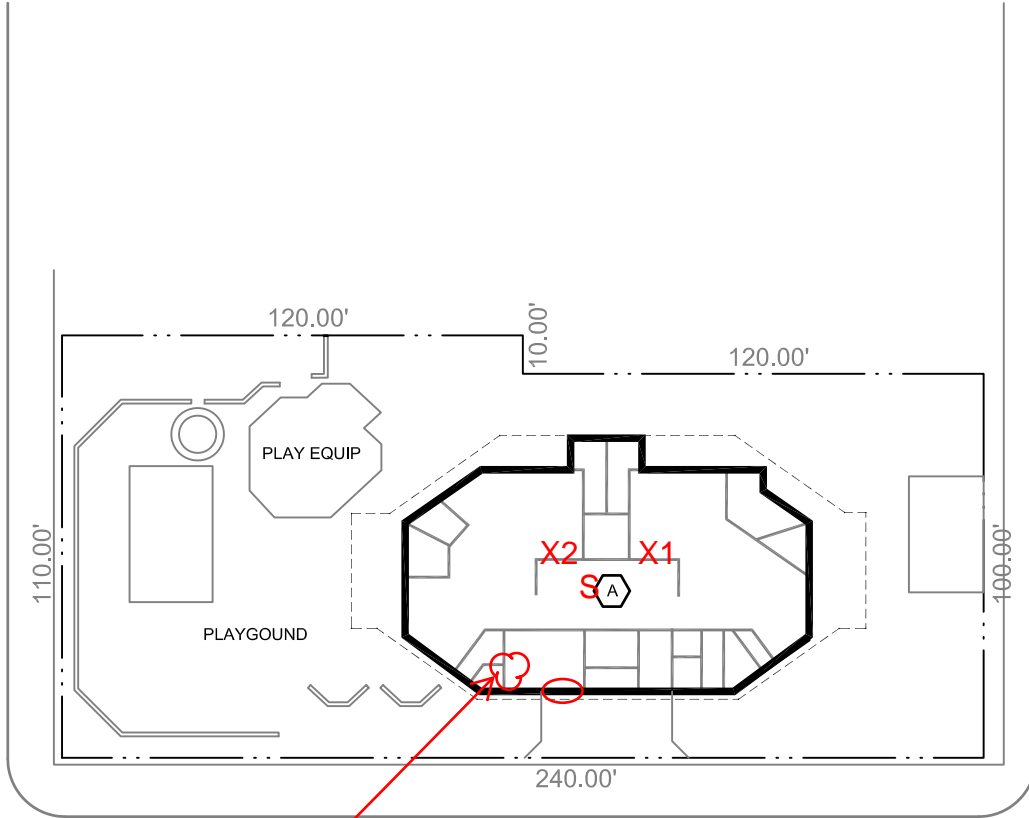

Principal's office

40TH AVE

- Door station
- X1 Desk station 1
- X2 Desk station 2
- S Server room/Equipment

The existing desk phone  
in Principal's office shall  
be programmed into Hunt  
group to unlock the door.



### SITE PLAN

817 - JEFFERSON C.D.C.  
1975 40TH AVENUE, OAKLAND, CA 94601-4251

BROADWAY TERRACE

# UPPER CAMPUS MAP

OF OAKLAND TECHNICAL HIGH SCHOOL

5263 Broadway Terrace  
Oakland, CA 94618

Science Lab 16

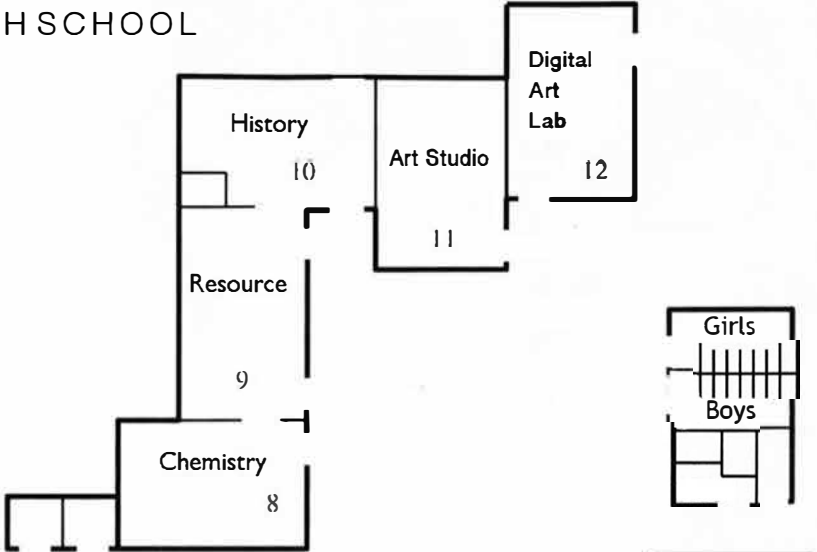

**2 Door Stations**

**UPPER YARD**  
(Event Parking)

- Door station
- X1 Main office
- X2 Principal's office
- S Server room/Equipment

Faculty Parking

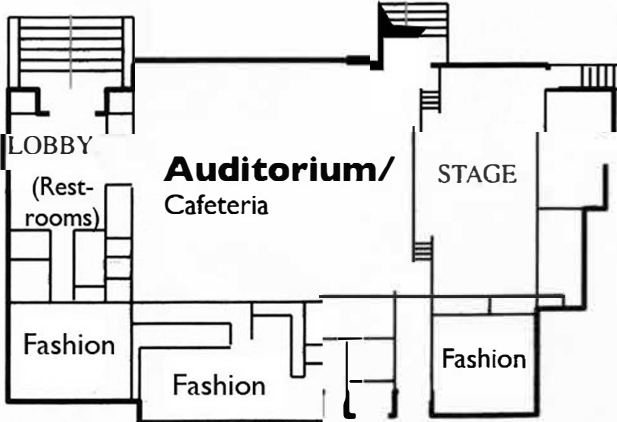
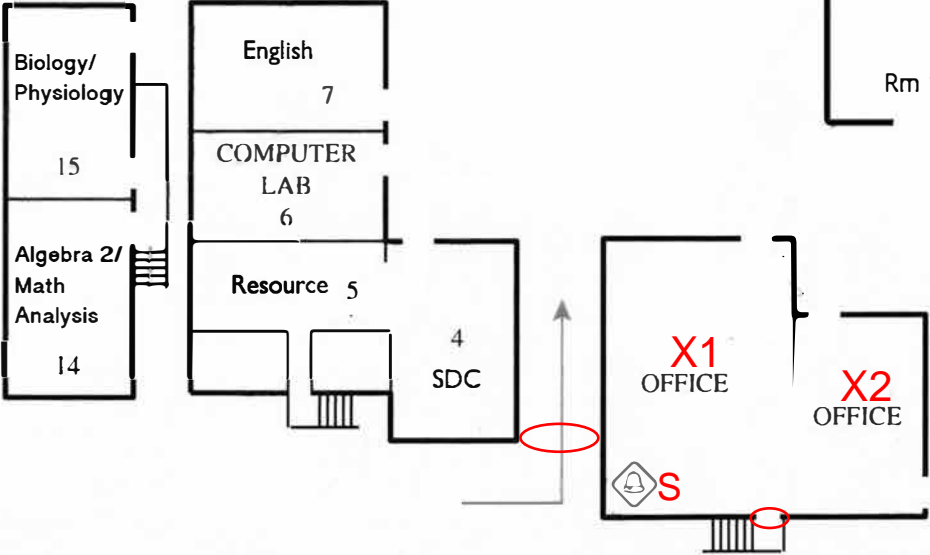

CLIFTON STREET

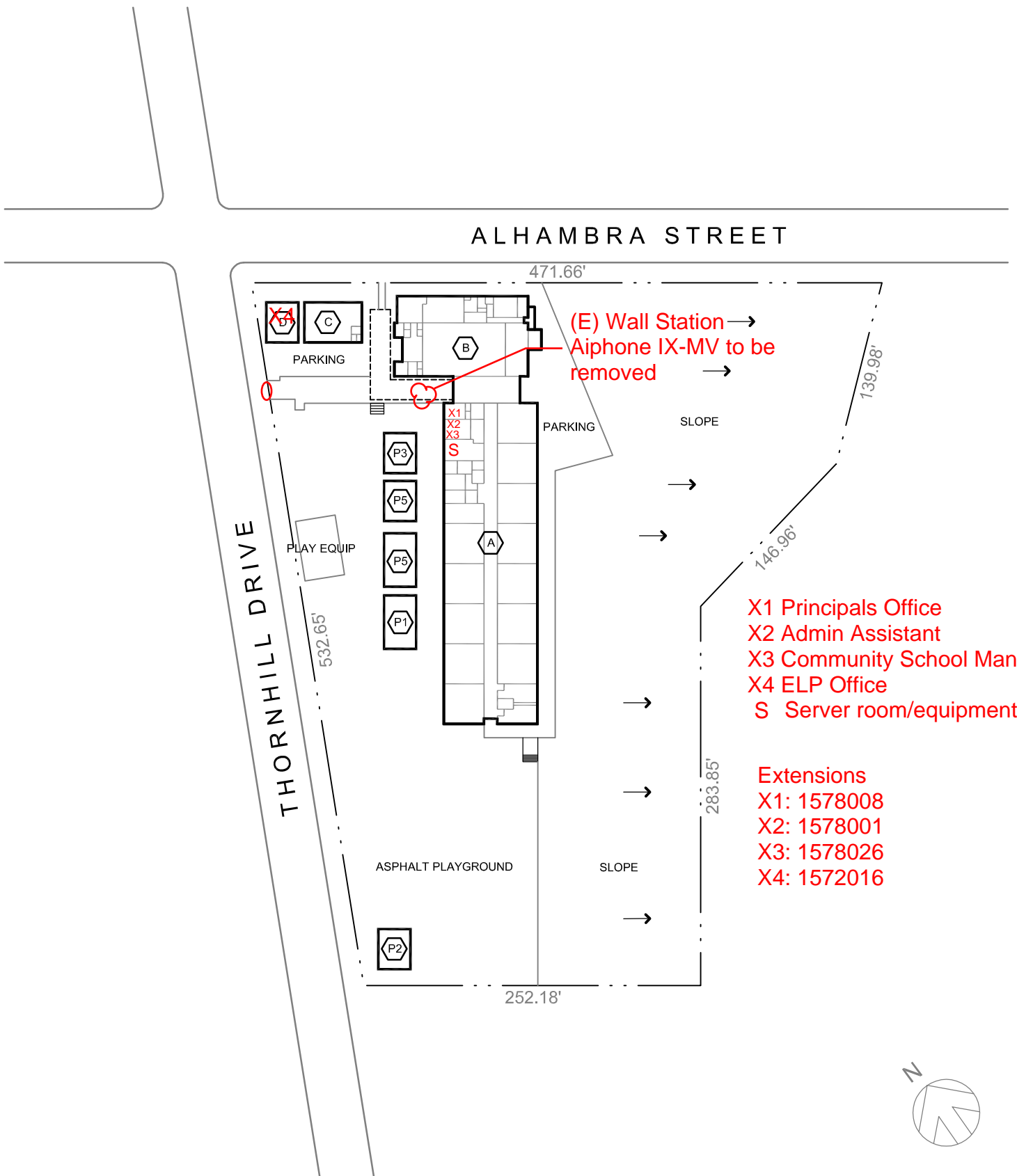

- X1 Principals Office
- X2 Admin Assistant
- X3 Community School Manager
- X4 ELP Office
- S Server room/equipment
  
- Extensions
- X1: 1578008
- X2: 1578001
- X3: 1578026
- X4: 1572016

**SITE PLAN**

**157 - THORNHILL ELEMENTARY SCHOOL**  
 5880 THORNHILL DRIVE, OAKLAND, CA 94611-2147



Date: 1/18/2013

Scale: 1"=100'-0"

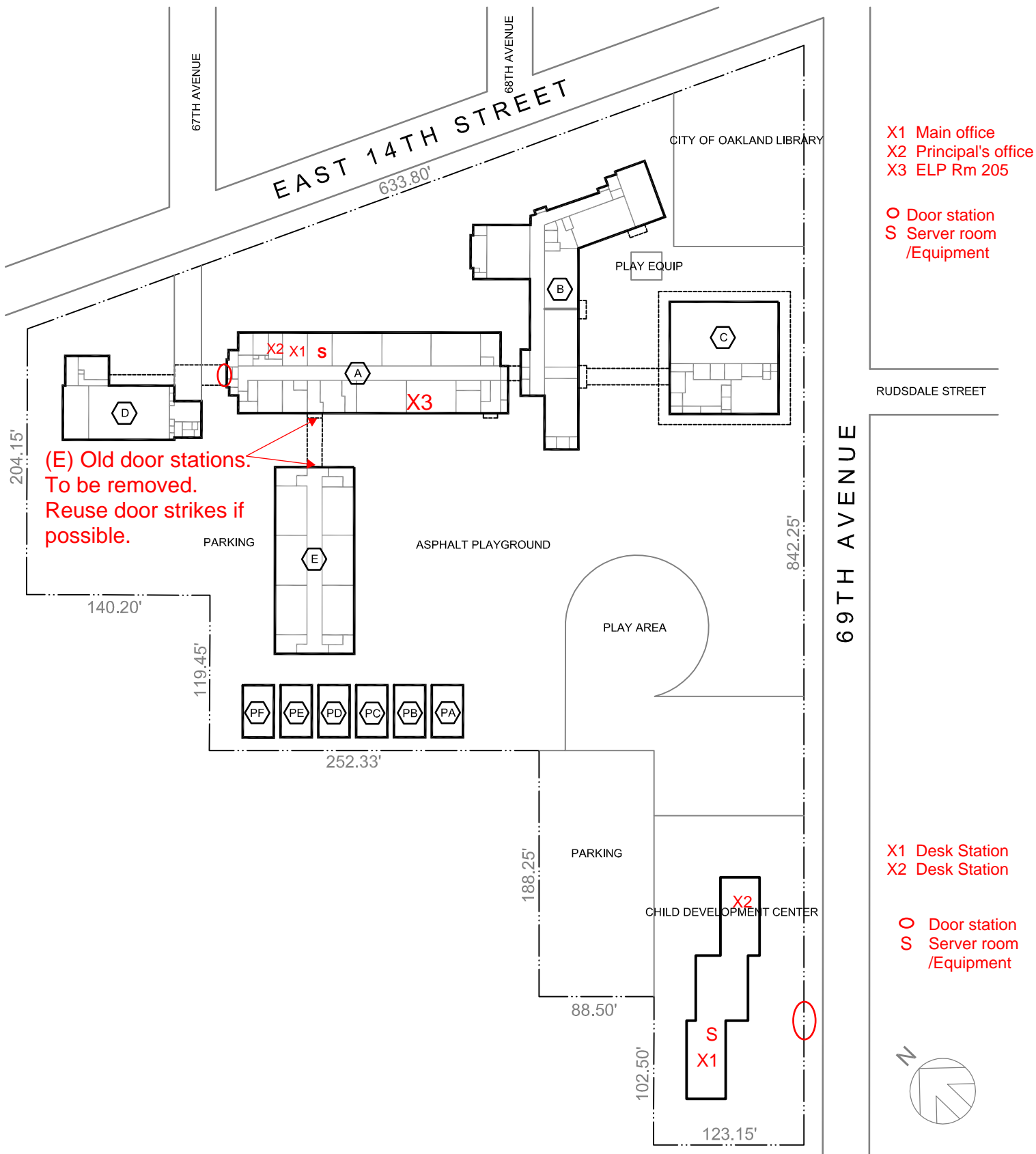

**SITE PLAN**

**134 - LOCKWOOD ELEMENTARY SCHOOL**  
 6701 EAST 14TH STREET, OAKLAND, CA 94621-3501



Date: 1/18/2013

Scale: 1"=100'-0"

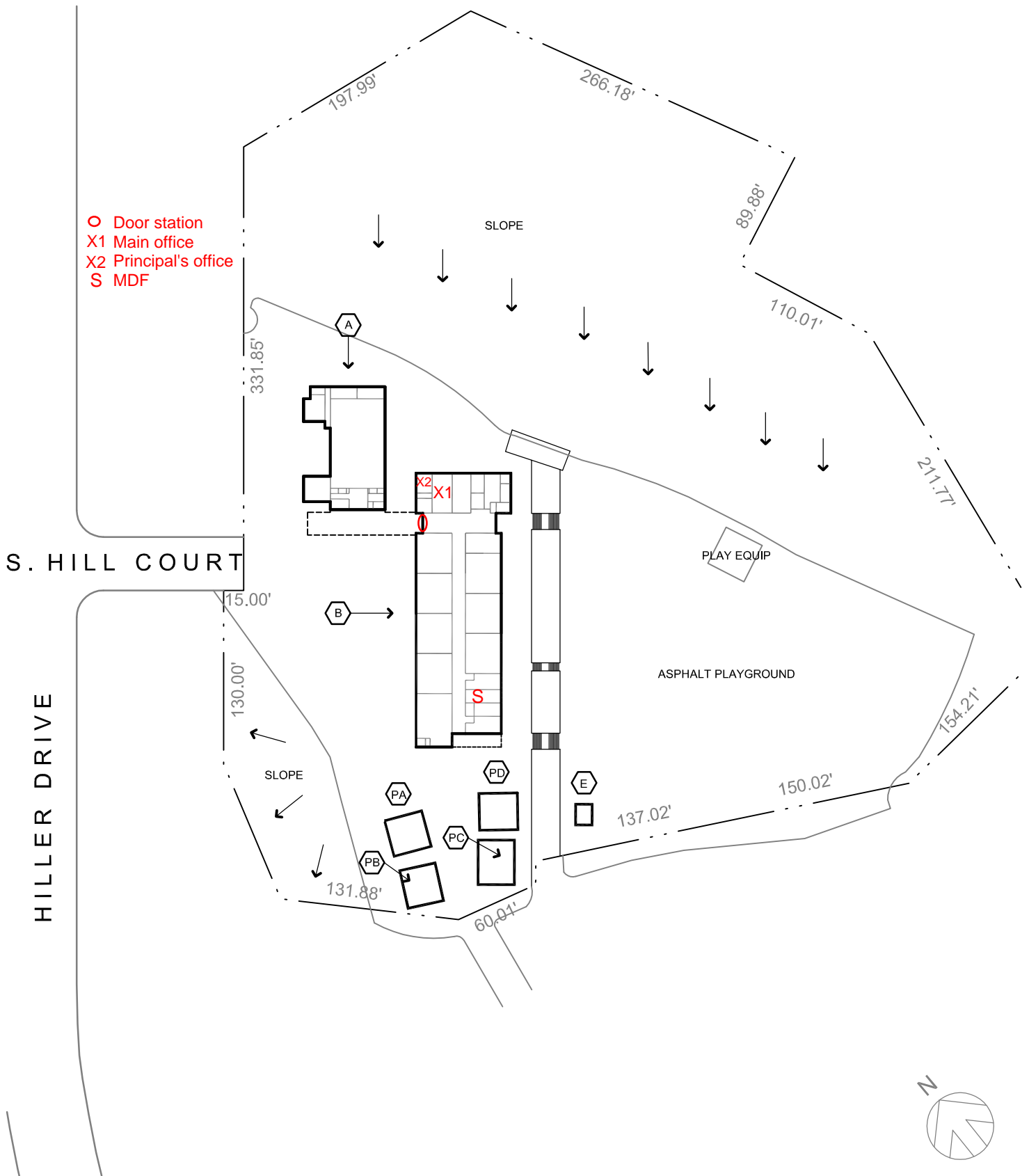

- Door station
- X1 Main office
- X2 Principal's office
- S MDF

**SITE PLAN**

**171 - HENRY KAISER ELEMENTARY SCHOOL**  
 25 SOUTH HILL COURT, OAKLAND, CA 94618-2306



Date: 1/18/2013

Scale: 1"=100'-0"



- Door station
- X1 Main office
- X2 Principal's office
- X3 ELP office (Room 15)
- X4 CDC (Room 1)
- S MDF

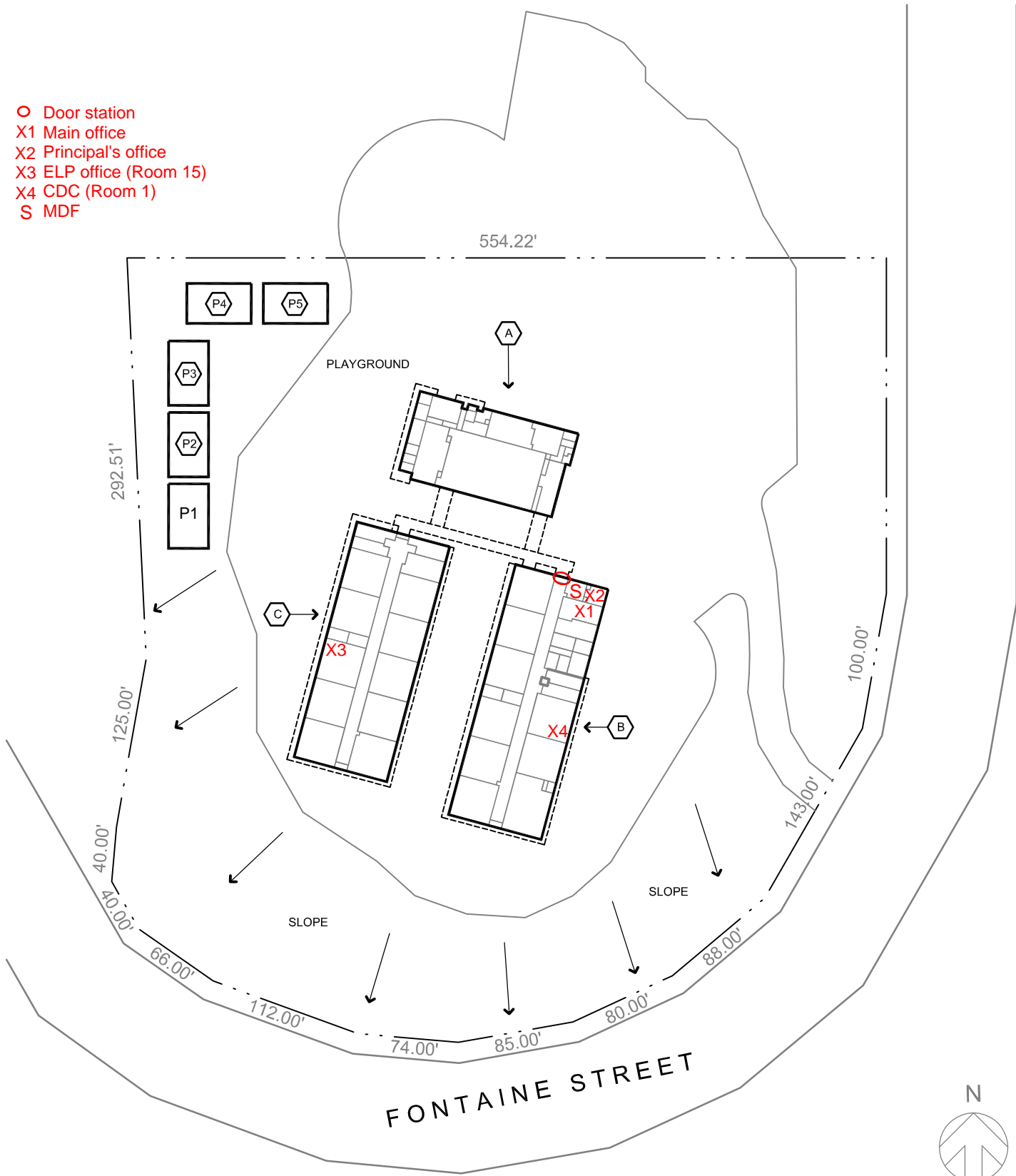

**SITE PLAN**

**166 - OAKLAND ACADEMY OF KNOWLEDGE**  
 8755 FONTAINE STREET, OAKLAND, CA 94605-4141



Date: 1/18/2013

Scale: 1"=100'-0"

**ADDENDUM NO. 1**

November 13, 2023

**Various Sites – Door Entry Systems Group 5 & 6 Project  
OAKLAND UNIFIED SCHOOL DISTRICT**

**OUSD PROJECT NUMBER 23126 & 23127**

Oakland Unified School District  
Facilities Planning & Management  
955 High Street, Oakland, CA 94601

The following changes, additions, modifications and corrections hereinafter set forth shall apply to the Bid Documents for the project and shall be made a part thereof and subject to all the requirements thereof, as if originally specified and/or shown.

Addendum No. 1

The Addendum to change Bid due date:

**The Bid Due date is being changed to November 28, 2023. Bids to be received by 2 p.m.**

See attached Revised Bid Cover Sheet

RECEIPT OF THIS ADDENDUM MUST BE ACKNOWLEDGED ON  
THE FORM OF PROPOSAL

End of Addendum No. 1

**BID COVER SHEET**  
**DOCUMENT 00 31 00**

OAKLAND UNIFIED SCHOOL DISTRICT  
Division of Facilities Planning and Management  
955 High Street  
Oakland, CA 94601

**BIDS MUST BE SEALED AND SUBMITTED TO:**

FRONT DESK  
955 HIGH STREET  
OAKLAND, CA 94601

**THIS SHEET MUST BE ATTACHED TO THE FRONT OF YOUR BID ENVELOPE**

**PLEASE NOTE: BID RESULTS WILL BE MADE AVAILABLE VIA EMAIL.**

**THANK YOU IN ADVANCE FOR YOUR PATIENCE AND COOPERATION.**

**Bid for: Various Sites Door Entry Systems Group 5 & 6**

**Project No.: 23126 & 23127**

**Bidder:**

\_\_\_\_\_  
Please print full (Company Name, Address)

\_\_\_\_\_  
Please provide both: (Phone, Fax)

**Bids are due: November 28, 2023, at 2:00 p.m.**

(Bid will not be considered if submitted after this date and time)

TIME STAMP HERE:

RECEIVED BY:

# NOTICE TO BIDDERS - DOOR ENTRY SYSTEMS VARIOUS SITES GROUP 5 & 6

Kyle

Search for all messages with label Kyle

Remove label Kyle from this conversation

sanchit

Search for all messages with label sanchit

Remove label sanchit from this conversation



**Juanita Hunter** <[juanita.hunter@ousd.org](mailto:juanita.hunter@ousd.org)>

Thu, Nov  
9, 2:14 PM

to David, Christopher, Leo, Kyle, Sanchit

Dear Prospective bidders,

The District is pleased to invite your firm to submit a bid for the above-mentioned project. See the attached Notice to Bidders for your reference.

Best Regards,

*Juanita Hunter, Specialist, Facilities Contracts & Bids  
Facilities Planning & Management  
955 High Street, Oakland, CA 94601  
P 510-535-7044, F 510-535-7040  
OUSD "Education Matters"*  
**One attachment** • Scanned by Gmail

# TRADE JOURNALS - NOTICE TO BIDDERS - DOOR ENTRY SYSTEMS VARIOUS SITES - GRP 5 & 6

External

PLAN ROOMS

Search for all messages with label PLAN ROOMS

Remove label PLAN ROOMS from this conversation



**Juanita Hunter** <juanita.hunter@ousd.org>

Thu, Nov  
9, 2:10 PM

to Support@bidamerica.com, doug, sbe, cacgoodfaith, candspublishing, sarah, info, info, support, info

Hello Trade Journals,

The District is seeking bids from certified experienced contractors for the above-mentioned project. I am forwarding a copy of the bid invitation For your reference to send to all qualified firms.

Best Regards,

*Juanita Hunter, Specialist, Facilities Contracts & Bids  
Facilities Planning & Management  
955 High Street, Oakland, CA 94601  
P 510-535-7044, F 510-535-7040  
OUSD "Education Matters"*  
**One attachment** • Scanned by Gmail

**SUFFICIENT FUNDS DECLARATION**

**DOCUMENT 00 11 13**

**(Labor Code section 2810)**

To Be Executed by Bidder and Submitted with Bid

Owner: Oakland Unified School District  
Contract: Various Sites Door Entry Systems Group 5 & 6

I, CHRISTOPHER KOEYER declare that I am the OWNER  
[insert title] of DATA MEDIA SERVICES the entity making and submitting the bid for  
the above Project that accompanies this Declaration, and that such bid includes sufficient  
funds to permit DATA MEDIA SERVICES [insert name of entity] to comply with all local,  
state or federal labor laws or regulations during the Project, including payment of  
prevailing wage, and that DATA MEDIA SERVICES [insert name of entity] will comply with  
the provisions of Labor Code section 2810(d) if awarded the Contract.

I declare under penalty of perjury under the laws of the State of California that the  
foregoing is true and correct and executed on 21 2023, at Stockton [city],  
CA [state].

Date: 12/21/2023



Signature

Print Name: Christopher Koeyer

Print Title: Owner

**PREVAILING WAGE AND  
RELATED LABOR REQUIREMENTS CERTIFICATION  
DOCUMENT 00 40 06**

PROJECT/CONTRACT NO. 23127 between Oakland Unified School District ("District") and DATA MEDIA SERVICES INC. ("Contractor" or "Bidder") ("Contract" or "Project").

I hereby certify that I will conform to the State of California public works contract requirements regarding prevailing wages, benefits, on-site audits with 48-hours' notice, payroll records, and apprentice and trainee employment requirements, for all Work on the above Project including, without limitation, labor compliance monitoring and enforcement by the Department of Industrial Relations.

I hereby certify that I will also conform to the Federal Labor Standards Provisions regarding minimum wages, withholding, payrolls and basic records, apprentice and trainee employment requirements, equal employment opportunity requirements, Copeland Act requirements, Davis-Bacon and Related Act requirements, Contract Work Hours and Safety Standards Act requirements, and any and all other applicable requirements for federal funding for all Work on the above Project.

Date: 12/21/2023  
Proper Name of Contractor: DATA MEDIA SERVICES INC.  
Signature: [Handwritten Signature]  
Print Name: CHRISTOPHER KOAYEN  
Title: OWNER

END OF DOCUMENT

**PREVAILING WAGE AND  
RELATED LABOR REQUIREMENTS CERTIFICATION  
DOCUMENT 00 40 06**

PROJECT/CONTRACT NO. 23126 between Oakland Unified School District ("District") and DATA MEDIA SERVICES INC. ("Contractor" or "Bidder") ("Contract" or "Project").

I hereby certify that I will conform to the State of California public works contract requirements regarding prevailing wages, benefits, on-site audits with 48-hours' notice, payroll records, and apprentice and trainee employment requirements, for all Work on the above Project including, without limitation, labor compliance monitoring and enforcement by the Department of Industrial Relations.

I hereby certify that I will also conform to the Federal Labor Standards Provisions regarding minimum wages, withholding, payrolls and basic records, apprentice and trainee employment requirements, equal employment opportunity requirements, Copeland Act requirements, Davis-Bacon and Related Act requirements, Contract Work Hours and Safety Standards Act requirements, and any and all other applicable requirements for federal funding for all Work on the above Project.

Date: 12/21/2023  
Proper Name of Contractor: DATA MEDIA SERVICES INC.  
Signature: [Handwritten Signature]  
Print Name: CHRISTOPHER KOYAYEN  
Title: OWNER

END OF DOCUMENT





# CERTIFICATE OF LIABILITY INSURANCE

DATE (MM/DD/YYYY)  
12/15/2023

THIS CERTIFICATE IS ISSUED AS A MATTER OF INFORMATION ONLY AND CONFERS NO RIGHTS UPON THE CERTIFICATE HOLDER. THIS CERTIFICATE DOES NOT AFFIRMATIVELY OR NEGATIVELY AMEND, EXTEND OR ALTER THE COVERAGE AFFORDED BY THE POLICIES BELOW. THIS CERTIFICATE OF INSURANCE DOES NOT CONSTITUTE A CONTRACT BETWEEN THE ISSUING INSURER(S), AUTHORIZED REPRESENTATIVE OR PRODUCER, AND THE CERTIFICATE HOLDER.

**IMPORTANT:** If the certificate holder is an **ADDITIONAL INSURED**, the policy(ies) must have **ADDITIONAL INSURED** provisions or be endorsed. If **SUBROGATION IS WAIVED**, subject to the terms and conditions of the policy, certain policies may require an endorsement. A statement on this certificate does not confer rights to the certificate holder in lieu of such endorsement(s).

PRODUCER	American Tri-Star Insurance Services, Inc. 16162 Beach Blvd Ste 100 Huntington Beach, CA. 92647	CONTACT NAME:	Anthony Gallo	
		PHONE (A/C, No, Ext):	(619) 919-0325	FAX (A/C, No):
		E-MAIL ADDRESS:	anthony@amtsi.com	
		INSURER(S) AFFORDING COVERAGE		NAIC #
		INSURER A :	Spinnaker Insurance Company	24376
INSURED	DATA MEDIA SERVICES INC 668 Queensland Cir Stockton, California 95206	INSURER B :	California Automobile Insurance Company-MERCURY	38342
		INSURER C :		
		INSURER D :		
		INSURER E :		
		INSURER F :		

<b>COVERAGES</b>	<b>CERTIFICATE NUMBER:</b>	<b>REVISION NUMBER:</b>
------------------	----------------------------	-------------------------

THIS IS TO CERTIFY THAT THE POLICIES OF INSURANCE LISTED BELOW HAVE BEEN ISSUED TO THE INSURED NAMED ABOVE FOR THE POLICY PERIOD INDICATED. NOTWITHSTANDING ANY REQUIREMENT, TERM OR CONDITION OF ANY CONTRACT OR OTHER DOCUMENT WITH RESPECT TO WHICH THIS CERTIFICATE MAY BE ISSUED OR MAY PERTAIN, THE INSURANCE AFFORDED BY THE POLICIES DESCRIBED HEREIN IS SUBJECT TO ALL THE TERMS, EXCLUSIONS AND CONDITIONS OF SUCH POLICIES. LIMITS SHOWN MAY HAVE BEEN REDUCED BY PAID CLAIMS.

INSTR	TYPE OF INSURANCE	ADDL INSD	SUBR WVD	POLICY NUMBER	POLICY EFF (MM/DD/YYYY)	POLICY EXP (MM/DD/YYYY)	LIMITS
A	<input checked="" type="checkbox"/> COMMERCIAL GENERAL LIABILITY <input type="checkbox"/> CLAIMS-MADE <input checked="" type="checkbox"/> OCCUR GEN'L AGGREGATE LIMIT APPLIES PER: <input checked="" type="checkbox"/> POLICY <input type="checkbox"/> PROJECT <input type="checkbox"/> LOC OTHER:	X	Y	HBW4295943XB1	12/15/2023	12/15/2024	EACH OCCURRENCE \$1,000,000 DAMAGE TO RENTED PREMISES (Ea occurrence) \$100,000 MED EXP (Any one person) \$5,000 PERSONAL & ADV INJURY \$1,000,000 GENERAL AGGREGATE \$2,000,000 PRODUCTS - COMP/OP AGG \$2,000,000
B	<input checked="" type="checkbox"/> AUTOMOBILE LIABILITY <input checked="" type="checkbox"/> ANY AUTO <input type="checkbox"/> OWNED AUTOS ONLY <input checked="" type="checkbox"/> SCHEDULED AUTOS <input type="checkbox"/> HIRED AUTOS ONLY <input type="checkbox"/> NON-OWNED AUTOS ONLY	X	Y	BA040000086017	12/15/2023	12/15/2024	COMBINED SINGLE LIMIT (Ea accident) \$1,000,000 BODILY INJURY (Per person) BODILY INJURY (Per accident) PROPERTY DAMAGE (Per accident)
	<input type="checkbox"/> UMBRELLA LIAB <input type="checkbox"/> OCCUR <input type="checkbox"/> EXCESS LIAB <input type="checkbox"/> CLAIMS-MADE DED RETENTION						EACH OCCURRENCE AGGREGATE
	<input type="checkbox"/> WORKERS COMPENSATION AND EMPLOYERS' LIABILITY ANY PROPRIETOR/PARTNER/EXECUTIVE <input type="checkbox"/> Y/N OFFICER/MEMBER EXCLUDED? <input type="checkbox"/> N/A (Mandatory in NH) If yes, describe under DESCRIPTION OF OPERATIONS below						<input type="checkbox"/> PER STATUTE <input type="checkbox"/> OTHER E.L. EACH ACCIDENT E.L. DISEASE - EA EMPLOYEE E.L. DISEASE - POLICY LIMIT
	<input type="checkbox"/> PROFESSIONAL LIABILITY						EACH CLAIM AGGREGATE

DESCRIPTION OF OPERATIONS / LOCATIONS / VEHICLES (ACORD 101, Additional Remarks Schedule, may be attached if more space is required)  
 HBW4295943XB1 - CG 20 01 04 13 - PRIMARY AND NONCONTRIBUTORY - OTHER INSURANCE CONDITION  
 As required by written contract, the following endorsements apply to the Certificate Holder and/or any other entity named in this section: General Liability  
 Additional Insured (Ongoing & Completed Operations) CG2010 04-13 & CG2037 04-13, Waiver of Subrogation RSG14048 10-08, Primary & Non-Contributory CG2001 04-13.

30 DAY CANCELLATION NOTICE APPLIES  
CERTIFICATE HOLDER IS ALSO ADDITIONALLY INSURED.

<b>CERTIFICATE HOLDER</b>	<b>CANCELLATION</b>
Oakland Unified School District 1000 Broadway, Suite 680 Oakland, CA. 94607	SHOULD ANY OF THE ABOVE DESCRIBED POLICIES BE CANCELLED BEFORE THE EXPIRATION DATE THEREOF, NOTICE WILL BE DELIVERED IN ACCORDANCE WITH THE POLICY PROVISIONS.  AUTHORIZED REPRESENTATIVE 

**THIS ENDORSEMENT CHANGES THE POLICY. PLEASE READ IT CAREFULLY.**

**WAIVER OF TRANSFER OF RIGHTS OF RECOVERY  
AGAINST OTHERS TO US**

This endorsement modifies insurance provided under the following:

BUSINESSOWNERS COVERAGE FORM

**SCHEDULE**

<b>Name Of Person Or Organization:</b>
Oakland Unified School District 1000
Information required to complete this Schedule, if not shown above, will be shown in the Declarations.

Paragraph **K. Transfer Of Rights Of Recovery Against Others To Us** in **Section III – Common Policy Conditions** is amended by the addition of the following:

We waive any right of recovery we may have against the person or organization shown in the Schedule above because of payments we make for injury or damage arising out of your ongoing operations or "your work" done under a contract with that person or organization and included in the "products-completed operations hazard". This waiver applies only to the person or organization shown in the Schedule above.

**THIS ENDORSEMENT CHANGES THE POLICY. PLEASE READ IT CAREFULLY.**

**ADDITIONAL INSURED – OWNERS, LESSEES  
OR CONTRACTORS – SCHEDULED PERSON  
OR ORGANIZATION**

This endorsement modifies insurance provided under the following:

BUSINESSOWNERS COVERAGE FORM

**SCHEDULE**

Name Of Additional Insured Person(s) Or Organization(s):	Location(s) Of Covered Operations
Oakland Unified School District	Various
Information required to complete this Schedule, if not shown above, will be shown in the Declarations.	

The following is added to Paragraph **C. Who Is An Insured** in **Section II – Liability**:

- 3. Any person(s) or organization(s) shown in the Schedule is also an additional insured, but only with respect to liability for "bodily injury", "property damage" or "personal and advertising injury" caused, in whole or in part, by:
  - a. Your acts or omissions; or
  - b. The acts or omissions of those acting on your behalf;
 in the performance of your ongoing operations for the additional insured(s) at the location(s) designated above.

With respect to the insurance afforded to these additional insureds, the following additional exclusions apply:

This insurance does not apply to "bodily injury" or "property damage" occurring after:

- a. All work, including materials, parts or equipment furnished in connection with such work, on the project (other than service, maintenance or repairs) to be performed by or on behalf of the additional insured(s) at the location of the covered operations has been completed; or
- b. That portion of "your work" out of which the injury or damage arises has been put to its intended use by any person or organization other than another contractor or subcontractor engaged in performing operations for a principal as a part of the same project.

**THIS ENDORSEMENT CHANGES THE POLICY. PLEASE READ IT CAREFULLY.**

## **PRIMARY AND NONCONTRIBUTORY – OTHER INSURANCE CONDITION**

This endorsement modifies insurance provided under the following:

BUSINESSOWNERS COVERAGE FORM

The following is added to Paragraph H. **Other Insurance** of **Section III – Common Policy Conditions** and supersedes any provision to the contrary:

### **Primary And Noncontributory Insurance**

This insurance is primary to and will not seek contribution from any other insurance available to an additional insured under your policy provided that:

1. The additional insured is a Named Insured under such other insurance; and

2. You have agreed in writing in a contract or agreement that this insurance would be primary and would not seek contribution from any other insurance available to the additional insured.

## DIVISION OF FACILITIES PLANNING & MANAGEMENT ROUTING FORM

### Project Information

<b>Project Name</b>	Various Sites Door Entry Systems Grp 6- Thornhill ES, Oakland Academy of Knowledge, Lockwood Steam Academy, Lockwood CDC, & Kaiser Early Childhood Center	<b>Site</b>	918
---------------------	---	-------------	-----

### Basic Directions

**Services cannot be provided until the contract is awarded by the Board or is entered by the Superintendent pursuant to authority delegated by the Board.**

Attachment Checklist	<input checked="" type="checkbox"/> Proof of general liability insurance, including certificates and endorsements, if contract is over \$15,000 <input checked="" type="checkbox"/> Workers compensation insurance certification, unless vendor is a sole provider
----------------------	---

### Contractor Information

Contractor Name	Data Media Services, Inc.	Agency's Contact	Christopher Koayen			
OUSD Vendor ID #	006952	Title	President			
Street Address	668 Queensland Circle	City	Stockton	State	CA	Zip 95026
Telephone	510-639-1914	Policy Expires				
Contractor History	Previously been an OUSD contractor? <input checked="" type="checkbox"/> Yes <input type="checkbox"/> No		Worked as an OUSD employee? <input type="checkbox"/> Yes <input checked="" type="checkbox"/> No			
OUSD Project #	23127					

### Term of Original/Amended Contract

Date Work Will Begin (i.e., effective date of contract)	1-25-2024	Date Work Will End By (not more than 5 years from start date; for construction contracts, enter planned completion date)	4-23-2024
		New Date of Contract End (If Any)	

### Compensation/Revised Compensation

If New Contract, Total Contract Price (Lump Sum)	\$119,000.00	If New Contract, Total Contract Price (Not To Exceed)	\$
Pay Rate Per Hour (If Hourly)	\$	If Amendment, Change in Price	\$
Other Expenses		Requisition Number	

### Budget Information

*If you are planning to multi-fund a contract using LEP funds, please contact the State and Federal Office before completing requisition.*

Resource #	Funding Source	Org Key	Object Code	Amount
3213 9948	Fund 01 ESSER III	010-3213-0-9948-8500-6274-918-9130-0093-9999-23127	6274	\$119,000.00

### Approval and Routing (in order of approval steps)

Services cannot be provided before the contract is fully approved and a Purchase Order is issued. Signing this document affirms that to your knowledge services were not provided before a PO was issued.

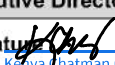
	<b>Division Head</b>	<b>Phone</b>	510-535-7038	<b>Fax</b>	510-535-7082
1.	<b>Executive Director, Facilities Planning and Management</b>				
	Signature  <small>Kenya Hatman (Dec 27, 2023 16:12 PST)</small>	Date Approved	Dec 27, 2023		
2.	<b>General Counsel, Department of Facilities Planning and Management</b>				
	Signature  Lozano Smith, approved as to form	Date Approved	12/27/23		
3.	<b>Chief Systems &amp; Services, Facilities Planning and Management</b>				
	Signature 	Date Approved	Dec 27, 2023		
4.	<b>Chief Financial Officer</b>				
	Signature	Date Approved			
5.	<b>President, Board of Education</b>				
	Signature	Date Approved			