

Board Office Use: <b>Legislative File Info.</b>	
File ID Number	23-0315
Introduction Date	3-8-2023
Enactment Number	23-0484
Enactment Date	3/8/2023 os



# Board Cover Memorandum

**To** Board of Education

**From** Kyla Johnson-Trammell, Superintendent  
Tadashi Nakadegawa, Deputy Chief Facilities Planning & Management

**Meeting Date** March 8, 2023

**Subject** Consent to Assign Agreement 2021-12-16 Engineering Procurement and Construction Agreement between Oakland Unified School District and SunPower Corporation

**Ask of the Board** Ratification by the Board of Education of Consent to Assign Agreement 2021-12-16 Engineering Procurement and Construction Agreement between Oakland Unified School District and SunPower Corporation

**Background** On December 15, 2021, the District entered into its Engineering Procurement and Construction Agreement with SunPower for a commercial-grade battery storage system and for SunPower to assist with procurement, installation, operation and maintain a commercial-grade battery storage system for the District.

On February 6, 2022, SunPower’s subsidiary, SunPower Corporation, Systems (“Systems” and together with SunPower and the SPWR Affiliates, the “SunPower Parties”), entered into an equity purchase agreement (as may be amended, restated, supplemented or otherwise modified from time to time, the “Purchase Agreement”) with TotalEnergies Renewables USA, LLC (together with its other affiliates, “TotalEnergies”). Pursuant to the terms set forth in the Purchase Agreement, TotalEnergies acquired the SunPower Parties’ Commercial & Industrial Solutions business (the “Business”), including all assets and liabilities relating to the Business (subject to certain exceptions), on May 31, 2022 (the “Sale Transaction”).

**Discussion** Pursuant to one or more of the Agreements, the applicable SPWR Affiliate(s) may be required to notify the District. On behalf of itself and each SPWR Affiliate, SunPower hereby notifies OUSD of the planned occurrence of the Assignments and requests that the District consent to, acknowledge and agree with each Assignment.

**Fiscal Impact** N/A

**Attachment(s)**

- Assignment letter
- File Id 21-2845

# SUNPOWER®

August 30, 2022  
Bundle No.: 933

**VIA CERTIFIED MAIL  
RETURN RECEIPT REQUESTED  
POSTAGE PREPAID**

Oakland Unified School District  
955 High Street  
Oakland, CA 94601  
Attention: Deputy Chief of Facilities Planning and Management

Re: *Request for Consent to Assignment*

Reference is hereby made to the agreements set forth on Exhibit A (each such agreement, as amended, restated, supplemented or otherwise modified, and together with all statements of work, purchase orders, exhibits, schedules and addenda thereto, an “**Agreement**” and, collectively, the “**Agreements**”), by and between the applicable affiliate of SunPower Corporation (“**SunPower**”) that is party to such agreement (each a “**SPWR Affiliate**”) and Oakland Unified School District (“**Counterparty**”) or its applicable affiliate (each, a “**Counterparty Affiliate**”).

As previously announced, on February 6, 2022, SunPower’s subsidiary, SunPower Corporation, Systems (“**Systems**” and together with SunPower and the SPWR Affiliates, the “**SunPower Parties**”), entered into an equity purchase agreement (as may be amended, restated, supplemented or otherwise modified from time to time, the “**Purchase Agreement**”) with TotalEnergies Renewables USA, LLC (together with its other affiliates, “**TotalEnergies**”). Pursuant to the terms set forth in the Purchase Agreement, TotalEnergies acquired the SunPower Parties’ Commercial & Industrial Solutions business (the “**Business**”), including all assets and liabilities relating to the Business (subject to certain exceptions), on May 31, 2022 (the “**Sale Transaction**”).

To effectuate the Sale Transaction, Systems formed TotalEnergies Distributed Generation USA, LLC (“**TEDGUSA**”) as its wholly owned subsidiary. Upon the consummation of the Sale Transaction, TEDGUSA became a direct, wholly owned subsidiary of TotalEnergies. As a result of the Sale Transaction, the SunPower Parties will assign each Agreement set forth in Exhibit A to (and each such Agreement shall hereby be assigned without any further action required on the part of the SunPower Parties, the Counterparty or any other person, as set forth below) TEDGUSA (each, an “**Assignment**”), upon the occurrence of the following conditions, to the extent such condition is applicable to such Agreement: (1) receipt of Counterparty’s consent in accordance with such Agreement, and (2) TEDGUSA’s receipt of certain necessary licenses, qualifications or other credentials (collectively, the “**Credentials**”) required to perform the work and other services under such Agreement and the project(s) associated therewith (collectively, the “**CIS Services**”) in the U.S. jurisdiction where each such project is located (each, a “**CIS Project State**”). During this transition, the SunPower Parties and TotalEnergies will operate under a transition services agreement to ensure ongoing performance under each Agreement in compliance with its terms.

Pursuant to one or more of the Agreements, the applicable SPWR Affiliate(s) may be required to notify the Counterparty of, or obtain the Counterparty’s consent, in connection with one or more Assignments. On behalf

of itself and each SPWR Affiliate, SunPower hereby notifies Counterparty of the planned occurrence of the Assignments and requests that Counterparty, on behalf of itself and each Counterparty Affiliate, consent to, acknowledge and agree with each Assignment, effective automatically upon the later of (a) Counterparty's consent to the Assignment(s) and (b) to the extent applicable, TEDGUSA having procured all necessary Credentials in the applicable CIS Project State(s) (the foregoing, the "**Consent Matters**").

Counterparty, on behalf of itself and each Counterparty Affiliate, further (i) acknowledges and agrees that none of the Sale Transaction, or any Assignment will constitute a breach, default or event of default under the Agreements and waives any termination or other rights under the Agreements arising as a result of any Assignment, (ii) acknowledges and agrees that any requirements or obligations of the applicable SPWR Affiliate(s) arising under the Agreements as a result of the Sale Transaction, including any obligations to provide notice or obtain the Company's consent under the Agreements, have hereby been satisfied or waived, (iii) agrees with Counterparty's and each Counterparty Affiliate's release and waiver of all termination rights, notice requirements, or other procedural requirements that may arise under the terms of the Agreements as a result of the Sale Transaction and any Assignment and (iv) agrees that the Agreements will continue in full force and effect pursuant to their respective existing terms and conditions after the consummation of any Assignment. This letter agreement shall in no event be deemed an admission that consent is required under the Agreements or that any rights or obligations of Counterparty would be triggered by the Sale Transaction or the Assignments.

Upon the effective date of the Assignments, each Agreement identified on Exhibit A as an "Assigned Agreement" shall henceforth be read as if TEDGUSA is a party to such Agreement, and TEDGUSA shall thereafter have all of the applicable SPWR Affiliate's rights, title, interest and benefits thereunder and shall assume and be solely responsible for all of the duties, obligations, commitments and liabilities of such SPWR Affiliate.

Please confirm your consent to, acknowledgement and agreement with, each of the Consent Matters by having a copy of this letter agreement signed by one of Counterparty's authorized representatives in the space provided below and return an executed copy by email to [Consents@sunpowercorp.com](mailto:Consents@sunpowercorp.com) and [legalnoticetedgus@totalenergies.com](mailto:legalnoticetedgus@totalenergies.com), with the original to follow by mail to Benjamin Einhouse at 1414 Harbour Way S, Richmond, CA 94804. Electronic copies of this letter agreement and signatures thereon shall have the same force, effect and legal status as originals. If you have any questions, please call us at 408.514.4050 or email us at [benjamin.einhouse@sunpowercorp.com](mailto:benjamin.einhouse@sunpowercorp.com).

Sincerely,

**SunPower Corporation**

Sincerely,

By:





---

Name: William Groen  
Title: Director, Finance

By signing below, the undersigned hereby consents to, acknowledges and agrees with each of the Consent Matters, effective automatically if and when TEDGUSA has procured all necessary Credentials in the applicable CIS Project State.

**Oakland Unified School District**

By:   
Name: Tadashi Nakadegawa  
Title: Deputy Chief Facilities Planning & Management  
Date: February 1, 2023

---

Mike Hutchinson, President, BOE

---

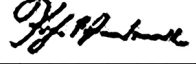
Kyla Johnson-Trammell, Superintendent & Secretary, BOE

Approved as to form on January 31, 2023 by Joshua R. Daniels

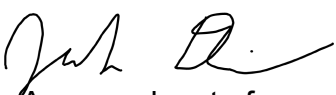
EXHIBIT A

AGREEMENTS

1. **Assigned Agreements.** The following Agreements (the “**Assigned Agreements**”) will be assigned by the specified SPWR Affiliate to TotalEnergies Distributed Generation USA, LLC, which is a wholly owned subsidiary of TotalEnergies Renewables USA, LLC:

<b>Agreement</b>	<b>Counterparty (or affiliate)</b>	<b>SPWR Affiliate</b>
2021-12-16 Engineering, Procurement and Construction Agreement entered by and between Oakland Unified School District and SunPower Corporation, Systems (Oakland HS Battery)	Oakland Unified School District	SunPower Corporation, Systems

Board Office Use: Legislative File Info.	
File ID Number	21-2845
Introduction Date	12-15-2021
Enactment Number	21-1977
Enactment Date	12/15/2021 er



## Memo

**To** Board of Education

**From** Kyla Johnson-Trammell, Superintendent  
Tadashi Nakadegawa, Deputy Chief, Facilities Planning and Management  
Brendan Havenar-Daughton, Energy & Sustainability Manager, Facilities Planning & Management

**Board Meeting Date** December 15, 2021

**Subject** Engineering, Procurement and Construction Agreement – SunPower Corporation, Systems – Oakland High School – Division of Facilities Planning and Management

**Action Requested** Approval by the Board of Education of Engineering, Procurement and Construction Agreement (“Agreement”) by and between the District and SunPower Corporation, Systems (“SunPower”), for the latter to procure, install, operate, and maintain a commercial-grade battery storage system (Tesla Mega Pack 2) at the Oakland High School campus, for an amount of \$1,438,735.00, with work scheduled to commence on December 15, 2021, and scheduled to end on June 30, 2023, pursuant to the Agreement.

**Discussion** Oakland Unified School District secured a \$1,380,400 incentive from the CPUC Self Generation Incentive Program (“SGIP”) for the installation of a 400 KW battery system at Oakland High School. As background information informing site selection, the OUSD Energy Manager applied for program participation for the District’s five (5) highest electricity consuming school sites and Oakland High School was selected by the SGIP program through a lottery system. The incentive covers 96% of the battery cost. The SGIP program has strict requirements that require the installation contract to be executed before the end of the calendar year. The SGIP incentive reservation will be lost if approval is not granted on December 15, 2021.

Battery storage systems can provide financial, environmental and resiliency benefits to school sites. Cost savings originate from the ability to deploy the battery’s stored electric capacity during the time of day when electricity costs are most expensive (energy arbitrage) as well as when a school site’s demand for electricity is high (demand shaving).

Likewise, higher electricity costs tend to correlate with times of the day when grid electricity is less “clean,” thus deploying the battery’s stored solar electricity reduces carbon emissions by exporting clean energy back into the grid or by powering the school’s demand for electricity during peak demand periods. This

battery will be connected to and charged by Oakland High School's rooftop solar system.

The battery also has the potential to provide grid-independent back-up power to keep critical electricity loads on line and operational during power outage events and during times of disaster. In theory, the battery can provide everlasting power if the sun continues to shine on the schools solar system. The resiliency benefit can be realized in phase 2 of this project upon determination of Oakland High School's critical loads.

Accordingly, SunPower to provide procurement, installation, operation, and maintenance services for a commercial-grade battery storage system (Tesla Mega Pack 2) at the Oakland High School campus, pursuant to the Agreement. (Government Code § 4217.10 et seq.)

**Recommendation**

Approval by the Board of Education of Engineering, Procurement and Construction Agreement ("Agreement") by and between the District and SunPower Corporation, Systems ("SunPower"), for the latter to procure, install, operate, and maintain a commercial-grade battery storage system (Tesla Mega Pack 2) at the Oakland High School campus, for an amount of \$1,438,735.00, with work scheduled to commence on December 15, 2021, and scheduled to end on June 30, 2023, pursuant to the Agreement.

**Fiscal Impact**

The SGIP incentive covers 96% of the battery's material and installation cost. The 15 year savings from the battery alone is projected to be in excess of \$500,000 which is an ROI of 240% (including required annual operations and maintenance costs). Furthermore, the project includes a utility rate change which is projected to save an additional \$70,000 per year. The combined (battery + rate change) 15 year estimated savings is over \$1,600,000 which is an ROI of 675%.

**Attachments**

- Engineering, Procurement and Construction Agreement
- Resolution 2122-0115 and Exhibit A
- LBU Waiver Letter

**BEFORE THE BOARD OF EDUCATION OF THE  
OAKLAND UNIFIED SCHOOL DISTRICT  
RESOLUTION NO. 2122-0115**

**RESOLUTION MAKING FINDINGS ON ENERGY SAVINGS  
AND DETERMINING OTHER MATTERS IN CONNECTION WITH  
ENERGY SERVICE AGREEMENTS  
(TESLA BATTERY SYSTEM)**

**WHEREAS**, it is the policy of the State of California and the intent of the State Legislature to promote all feasible means of energy conservation and all feasible uses of alternative energy supply sources; and

**WHEREAS, OAKLAND UNIFIED SCHOOL DISTRICT** (“District”) desires to reduce the rising costs of meeting the energy needs at its facilities; and

**WHEREAS**, the District proposes to contract with SunPower for the purchase and installation of a Tesla Battery Storage System (“System”) at Oakland High School, which will be accompanied by an Operations and Maintenance Agreement; and

**WHEREAS**, SunPower will provide “turnkey” services for the District, which will include the design, purchase, and construction of the System, including making arrangements for the interconnection of the System with the local utility; and

**WHEREAS**, the System will save the District energy costs by storing energy obtained at night, when rates are lower, for use during the day, when rates are higher, and by storing electricity generated by solar facilities; and

**WHEREAS**, SunPower has provided the District with an analysis, attached hereto as Exhibit A, and made part hereof by this reference, showing the financial and other benefits of employing the System, which SunPower estimates will be over \$1,000,000 over the life of the System; and

**WHEREAS**, Exhibit A includes data showing that the anticipated cost to the District for the System will be less than the anticipated cost to the District of electrical energy that the District would have consumed in the absence of such System; and

**WHEREAS**, the District has adopted Board Policy 7115, whereby the District has a goal of local business participation in District construction projects, with certain exceptions; and

**WHEREAS**, it was determined by the District that this Project may be waived from the requirements of said Board Policy because the System will help the District implement Government Code section 4217.10; and

**WHEREAS**, the District proposes to enter into the Energy, Procurement and Construction Agreement and Operations and Maintenance Agreement (collectively “Agreements”) each in



substantially the form presented at this meeting, subject to such changes, insertions or omissions as the Superintendent reasonably deems necessary following the Board's adoption of this Resolution; and

**WHEREAS**, pursuant to Government Code section 4217.12, this Board held a public hearing, public notice of which was given two weeks in advance, to receive public comment; and

**WHEREAS**, the System and the Agreements are in the best interests of the District; and

**WHEREAS**, the District's proposed approval of the Agreements and the installation of the System is a "Project" for purposes of the California Environmental Quality Act ("CEQA"); and

**WHEREAS**, the Guidelines for CEQA, California Code of Regulations Title 14, Chapter 13 ("State CEQA Guidelines"), exempt certain projects from further CEQA evaluation, including the following: (1) projects consisting of the new construction or conversion of small structures ("Class 3 Exemption"; Cal. Code Regs., tit. 14, § 15303); (2) projects consisting of the construction or placement of minor accessory structures to existing facilities ("Class 11 Exemption"; Cal. Code Regs., tit. 14, § 15311); and (3) projects consisting of minor additions to existing schools ("Class 14 Exemption"; Cal. Code Regs., tit. 14, § 15314), and the Project is categorically exempt under one or more of such exemptions; and

**WHEREAS**, the Project does not involve any of the following and so is eligible for a categorical exemption as described above under State CEQA Guidelines section 15300.2:

- (a) the cumulative impact of successive projects of the same type in the same place, which over time are significant;
- (b) an activity where there is a reasonable possibility that the activity will have a significant effect on the environment due to unusual circumstances;
- (c) a project which may result in damage to scenic resources, including but not limited to, trees, historic buildings, rock outcroppings, or similar resources, within a highway officially designated as a state scenic highway;
- (d) a hazardous waste site which is included on any list compiled pursuant to Section 65962.5 of the Government Code; and
- (e) a project which may cause a substantial adverse change in the significance of a historical resource.

**NOW, THEREFORE**, based upon the above-referenced recitals, the Board hereby finds, determines and orders as follows:

1. The System and the terms of the Agreement and related agreements are in the best interests of the District.

2. In accordance with Government Code section 4217.12, and based on data provided by Exhibit A, the Board finds that the anticipated cost to the District for electrical energy provided by the System will be less than the anticipated cost to the District of electrical energy that the District would have consumed in the absence of the System.

3. The Board hereby approves the Agreements in accordance with Government Code section 4217.12.

4. The Board hereby waives the requirements of Board Policy 7115.

5. Following the Board's adoption of this Resolution, and notwithstanding Board Policy 3312, the District's Superintendent is hereby authorized and directed to negotiate changes, insertions, and omissions to the Agreements, if needed to effectuate the intent of the Board, and thereafter to execute and deliver the Agreements and related forms, and present the same within sixty (60) calendar days for Board ratification. Agreements and related forms not ratified by the Board within sixty (60) calendar days shall be void.

6. The Project is hereby found to be exempt from the requirements of CEQA pursuant to the Class 3, Class 11, and Class 14 Exemptions, as described above.

7. District staff are hereby authorized to file and process a Notice of CEQA Exemption for the Project in accordance with CEQA and the State CEQA Guidelines, and the findings set forth in this resolution.

The foregoing Resolution was passed and adopted at a meeting of the Board of Education of the **OAKLAND UNIFIED SCHOOL DISTRICT** on December 15, 2021, by the following vote:

PREFERENTIAL AYE: None

PREFERENTIAL NOE: None

PREFERENTIAL ABSTENTION: None

PREFERENTIAL RECUSE: None

AYES: VanCedric Williams, Gary Yee, Mike Hutchinson, Clifford Thompson, Vice President Benjamin "Sam" Davis, President Shanthi Gonzales

NOES: None

ABSTAINED: None

RECUSED: None

ABSENT: Aimee Eng, Natalie Gallegos Chavez (Student Director), Samantha Pal (Student Director)

**CERTIFICATION**

We hereby certify that the foregoing is a full, true and correct copy of a Resolution passed at a Regular Meeting of the Board of Education of the Oakland Unified School District held on December 15, 2021.

<b>Legislative File</b>	
File ID Number:	21-2845
Introduction Date:	12-15-2021
Enactment Number:	21-1977
Enactment Date:	12-15-2021
By:	er

**OAKLAND UNIFIED SCHOOL DISTRICT**

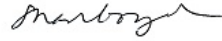

---

Shanthi Gonzales  
President, Board of Education

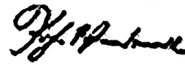

---

Dr. Kyla Johnson-Trammell  
Superintendent and Secretary, Board of Education

Approved as to Form



---

Facilities Counsel

# Exhibit A

**Oakland High School  
Annual Cost/Benefit Analysis**

**System Specifications and Assumptions**

Battery kW	407.7
Battery kWh	1,630.8
Battery Storage Investment	\$1,438,735
First Year Utility Expected Savings due to Battery Storage (\$)	\$123,693
Minimum BESS Operating Period	15 Years

**Operating Benefits and Costs During Years of Operation**

Year of Solar System Operation	Anticipated Benefit: Solar Avoided Utility Costs	Anticipated Benefit: Rate Switch B19V Option S Expected Savings	Anticipated Benefit: Storage Expected Savings on B19V Option S	Anticipated Benefit: Storage SGIP Utility Incentive	-	Cost: Energy Storage Operations & Maintenance	=	Anticipated Net Benefits to General Fund
2022	\$0	\$0	\$0	\$0		\$0		\$0
2023	\$0	\$83,117	\$40,576	\$690,200		(\$10,277)		\$803,616
2024	\$0	\$82,477	\$41,216	\$159,277		(\$10,492)		\$272,478
2025	\$0	\$81,837	\$41,856	\$159,277		(\$10,712)		\$272,258
2026	\$0	\$81,196	\$42,497	\$159,277		(\$10,936)		\$272,034
2027	\$0	\$80,556	\$43,137	\$159,277		(\$11,165)		\$271,805
2028	\$0	\$79,916	\$43,777	\$53,092		(\$11,399)		\$165,386
2029	\$0	\$79,276	\$44,417	\$0		(\$11,638)		\$112,055
2030	\$0	\$78,635	\$45,058	\$0		(\$11,882)		\$111,811
2031	\$0	\$77,995	\$45,698	\$0		(\$12,131)		\$111,562
2032	\$0	\$77,355	\$46,338	\$0		(\$12,386)		\$111,307
2033	\$0	\$76,715	\$46,978	\$0		(\$12,646)		\$111,047
2034	\$0	\$76,074	\$47,619	\$0		(\$12,911)		\$110,782
2035	\$0	\$75,434	\$48,259	\$0		(\$13,182)		\$110,511
2036	\$0	\$74,794	\$48,899	\$0		(\$13,459)		\$110,234
2037	\$0	\$74,154	\$49,539	\$0		(\$13,741)		\$109,952
2038	\$0	\$0	\$0	\$0		\$0		\$0
2039	\$0	\$0	\$0	\$0		\$0		\$0
2040	\$0	\$0	\$0	\$0		\$0		\$0
2041	\$0	\$0	\$0	\$0		\$0		\$0
2042	\$0	\$0	\$0	\$0		\$0		\$0
2043	\$0	\$0	\$0	\$0		\$0		\$0
2044	\$0	\$0	\$0	\$0		\$0		\$0
2045	\$0	\$0	\$0	\$0		\$0		\$0
2046	\$0	\$0	\$0	\$0		\$0		\$0
2047	\$0	\$0	\$0	\$0		\$0		\$0
<b>Total</b>	<b>\$0</b>	<b>\$1,179,531</b>	<b>\$675,864</b>	<b>\$1,380,400</b>		<b>(\$178,957)</b>		<b>\$3,056,838</b>

<b>Anticipated General Fund Benefits</b>	<b>\$3,056,838</b>
<b>- Upfront Battery System Cost</b>	<b>\$1,438,735</b>
<b>= Anticipated Net Savings to District</b>	<b>\$1,618,103</b>



**CONTRACT JUSTIFICATION FORM**

**This Form Shall Be Submitted to the Board Office With Every Agenda Contract.**

**Legislative File ID No. 21-2845**

**Department: Facilities Planning & Management**

**Vendor Name: Sun Power**

**Project Name: Battery Storage Oakland High School**

**Project No.:21117**

**Contract Term: Intended Start: 12-16-2021**

**Intended End: 06-30-2023**

**Total Cost Over Contract Term: \$1,438,735.00**

**Approved by: Tadashi Nakadegawa**

**Is Vendor a local Oakland Business or have they meet the requirements of the**

**Local Business Policy?**  Yes (No if Unchecked)

**How was this contractor or vendor selected?**

This vendor was selected based on expertise and unique experience with similar projects with the District related with Sun Power.

**Summarize the services or supplies this contractor or vendor will be providing.**

Vendor will provide financial, environmental and resiliency benefits, cost savings originate from the ability to deploy te battery's stored electric capacity during the time of day when electricity costs are most expensive (energy arbitrage).

**Was this contract competitively bid?**  Check box for "Yes" (If "No," leave box unchecked)

If "No," please answer the following questions:

- 1) How did you determine the price is competitive?

Sun power has done work for the District before. Based on their experience of expertise with this particular type of work, the District found that the contractor performed work quickly, accurately, efficiently, and at a reasonable cost to the District.

2) Please check the competitive bidding exception relied upon:

Construction Contract:

- Price is at or under UPCCAA threshold of \$60,000 (as of 1/1/19)
- CMAS contract [may only include “incidental work or service”] (Public Contract Code §§10101(a) and 10298(a)) – *contact legal counsel to discuss if applicable*
- Emergency contract (Public Contract Code §§22035 and 22050) – *contact legal counsel to discuss if applicable*
- No advantage to bidding – *contact legal counsel to discuss if applicable*
- Sole source contractor – *contact legal counsel to discuss if applicable*
- Completion contract – *contact legal counsel to discuss if applicable*
- Lease-leaseback contract RFP process – *contact legal counsel to discuss if applicable*
- Design-build contract RFP process – *contact legal counsel to discuss if applicable*
- Energy service contract – *contact legal counsel to discuss if applicable*
- Other: \_\_\_\_\_ – *contact legal counsel to discuss if applicable*

Consultant Contract:

- Construction project manager, land surveyor, or environmental services – selected based on demonstrated competence and professional qualifications (Government Code §4526)
- Architect or engineer – use of a fair, competitive RFP selection process (Government Code §§4529.10 et seq.)
- Architect or engineer when state funds being used – use of competitive process consistent with Government Code §§4526-4528 (Education Code §17070.50)
- Other professional or specially trained services or advice – no bidding or RFP required (Public Contract Code §20111(d) and Government Code §53060) – *contact legal counsel to discuss if applicable*
- For services other than above, the cost of services is \$96,700 or less (as of 1/1/21)
- No advantage to bidding (including sole source) – *contact legal counsel to discuss if applicable*

Purchasing Contract:

- Price is at or under bid threshold of \$96,700 (as of 1/1/21)
- Certain instructional materials (Public Contract Code §20118.3)

- Data processing systems and supporting software – choose one of three lowest bidders (Public Contract Code §20118.1)
- Electronic equipment – competitive negotiation (Public Contract Code §20118.2) – *contact legal counsel to discuss if applicable*
- CMAS contract [may only include “incidental work or service”] (Public Contract Code §§10101(a) and 10298(a)) – *contact legal counsel to discuss if applicable*
- Piggyback contract for purchase of personal property (Public Contract Code §20118) – *contact legal counsel to discuss if applicable*
- Supplies for emergency construction contract (Public Contract Code §§22035 and 22050) – *contact legal counsel to discuss if applicable*
- No advantage to bidding (including sole source) – *contact legal counsel to discuss if applicable*
- Other: \_\_\_\_\_

Maintenance Contract:

- Price is at or under bid threshold of \$96,700 (as of 1/1/21)
- No advantage to bidding (including sole source) – *contact legal counsel to discuss*
- Other: \_\_\_\_\_

3) Explain in detail the facts that support the applicability of the exception marked above:

Contractor will be providing specially trained services which does not require bidding.





OAKLAND UNIFIED  
SCHOOL DISTRICT

Community Schools, Thriving Students

Department of Facilities Planning and Management

MEMORANDUM

**Date:** November 8, 2021  
**To:** Brendan Havenar-Daughton  
**From:** Philip Lang, LBU Consultant  
**Subject:** LBU Review Waiver  
Battery Storage at Oakland High

---

California Government Code Section 4217 allows the District to forgo its standard low-bid public procurement process to implement turn-key water and energy service projects when the District finds this procurement method in its best interest. This procurement model ensures that Sun Power will implement the project for a Guaranteed Maximum Price with no change orders, complete the project on-time, and ensure that the systems are performing as specified in the design-build contract.

Based on the findings, it is recommended to waive the LBU requirements for the above reference project based on the implementation of California Government Code Section 4217.

Cc: Kenya Chatman  
Tadashi Nakadegawa

Local Business Utilization Program Consultants





Oakland Unified School District

---

**ENGINEERING, PROCUREMENT AND CONSTRUCTION AGREEMENT**

---

<u>SunPower Corporation, Systems,</u>	<u>Oakland Unified School District,</u>
Name and Title for Notices: Attn: Project Administrator Address: 1414 Harbour Way South, Richmond, CA 94804	Name and Title for Notices: Attn: Deputy Chief of Facilities Planning and Management Address: 955 High Street Oakland, CA 94601

This Engineering, Procurement and Construction Agreement (this “Agreement”) is entered into this 16th day of December, 2021 (the “Effective Date”) by and between SunPower Corporation, Systems, a Delaware corporation having its principal place of business at 1414 Harbour Way South, Richmond, CA, 94804 (“Installer”), and Oakland Unified School District having its principal place of business at 1000 Broadway, Suite 300, Oakland, CA 94607 (“Customer”). In the event of a conflict between the terms and conditions of this Agreement and the terms and conditions of any Work Authorization executed pursuant to this Agreement, the terms and conditions of this Agreement shall control.

## 1. DEFINITIONS.

- 1.1** “Agreement” has the meaning given to such term in the preamble hereto.
- 1.2** “Applicable Law” means any applicable federal, state, or local act, law, statute, ordinance, code, rule, regulation, Permit, order, judgment, consent, or approval of any Governmental Authority.
- 1.3** “Business Day” means any day other than a Saturday, Sunday, or a legal holiday in the State in which the System is being built. In the event a time period set forth in this Agreement or a Work Authorization expires on a Day that is not a Business Day, such period shall be deemed to expire on the next Business Day thereafter.
- 1.4** “Change Order” has the meaning set forth in Section 2.7(a) (*Change Orders*).
- 1.5** “Commencement Date” means the date on which Installer commences performance of the Work on the Site.
- 1.6** “Contract Price” has the meaning set forth in Section 4.1 (*Contract Price*).
- 1.7** “Critical Change Order” has the meaning set forth in Section 2.7(d) (*Change Orders*).
- 1.8** “Customer” has the meaning given to such term in the preamble hereto.
- 1.9** “Customer Permits” means those Permits designated as Customer Permits in the applicable Work Authorization.
- 1.10** “Customer Person” has the meaning set forth in Section 2.7(c) (*Change Orders*).
- 1.11** “Day” means a period of 24 consecutive hours from 12:00 midnight (Pacific time), and shall include Saturdays, Sundays, and all holidays except that in the event a time period set forth in this Agreement or a Work Authorization expires on a Day that is not a Business Day, such period shall be deemed to expire on the next Business Day thereafter.

- 
- 1.12** “Design Submittal” means (i) mechanical and electrical drawings, (ii) product description information, (iii) detailed project schedule, (iv) permit package and related documents and (v) any other documents submitted in connection with the applicable System.
- 1.13** “Effective Date” means the date set forth in the preamble hereto.
- 1.14** “Energy Display” has the meaning set forth in Appendix 3 attached to the Work Authorization.
- 1.15** “Final Completion” with respect to a System, means the date on which the System has achieved Substantial Completion and all Punch List Items have been completed.
- 1.16** “Final Completion Date” has the meaning set forth in Section 3.1 (*Substantial Completion; Final Completion*).
- 1.17** “Final Completion Notice” means the notice that shall be issued by Installer upon Final Completion.
- 1.18** “Force Majeure Event” means any event or circumstance beyond the reasonable control of Installer, including, without limitation, strikes, fires, floods, hurricanes, typhoons, winds in excess of 90 mph, volcanoes, earthquakes, tornados, vandalism, terrorism, war, acts or omissions of any Governmental Authority or any other similar circumstances beyond the reasonable control of Installer.
- 1.19** “Governmental Authority” means any federal, state, local or other governmental, regulatory, or judicial agency, authority, public utility, or other entity having legal jurisdiction over the Site or a System.
- 1.20** “Hazardous Material” means all pollutants, contaminants, and chemicals and any other carcinogenic, ignitable, corrosive, reactive, toxic, or otherwise hazardous substances (and materials and substances containing or contained by the foregoing) subject to regulation, control, or remediation under applicable environmental laws.
- 1.21** “Host” has the meaning set forth in Section 10.1 (*Acknowledgment and Consent of Host*).
- 1.22** “Installer” has the meaning set forth in the preamble hereto.
- 1.23** “Installer Permits” means those Permits designated as Installer Permits in the applicable Work Authorization.
- 1.24** “Interconnection Agreement” means an agreement between Customer and any utility for the interconnection of any System to the electrical grid.
- 1.25** “Interconnection Equipment” means all standard interconnection-related equipment on Customer side of the main service meter, including panel circuit breakers, utility lockable disconnect switches, NGO metering, conduit and wiring and, if necessary, replacement of the local utility provider’s revenue meter for net-metering purposes.
- 1.26** “Interconnection Point” means the point where the System is interconnected to Customer’s electrical equipment.
- 1.27** “Local Business Utilization Policy” means the policy adopted and approved by the Board of Education for the Oakland Unified School District on January 29, 2014, in connection with the Resolution of the Local, Small Local and Small Local Resident Business Enterprise Program pursuant to File ID No. 13-2935, in the form attached hereto as Exhibit F.
- 1.28** “Notice” means any written notice required or permitted to be given by one Party to the other Party under this Agreement.



## Oakland Unified School District

- 
- 1.29** “Notice to Proceed” means the Customer’s written notice given to Installer directing Installer to commence performance of the entire Work. Unless specifically stated otherwise, a fully executed Work Authorization shall constitute a Notice to Proceed.
- 1.30** “Parties” means Customer and Installer collectively, and each of them may be referred to as a “Party.”
- 1.31** “Permit” means each and every national, autonomic, regional, and local license, authorization, certification, filing, recording, permit or other approval with or of any Governmental Authority, including, without limitation, each and every environmental, construction or operating permit and any agreement, consent, or approval from or with any other Person that is required by any Applicable Law or that is otherwise necessary for the performance of the Work.
- 1.32** “Progress Payment” has the meaning set forth in Section 4.2 (*Payments of the Contract Price*).
- 1.33** “Project Labor Agreement” means Project Labor Agreement, dated September 19, 2016, by and among the Customer, the Buildings and Construction Trades Council of Alameda County, AFL-CIO, all affiliated local union signatories, and all contractors and subcontractors who become signatory thereto, in the form attached hereto as Exhibit G.
- 1.34** “Project Schedule” means the schedule for the performance of the Work by Installer, set forth in the applicable Work Authorization.
- 1.35** “Punch List” has the meaning set forth in Section 3.2 (*Punch List*).
- 1.36** “Rebate Program” means any rebate or other incentive program in effect as of the Effective Date and offered with respect to any System by any public utility or Governmental Authority.
- 1.37** “Schedule of Values” means the schedule of values set forth in the applicable Work Authorization.
- 1.38** “Site” means the site for installation of a System, as specified in the applicable Work Authorization.
- 1.39** “Specifications” means the specifications with respect to a System, as set forth in the applicable Work Authorization and, once accepted, as provided in the applicable Design Submittal.
- 1.40** “Substantial Completion” means the System is mechanically, electrically, and structurally constructed in accordance with this Agreement and the applicable Work Authorization (except for Punch List items) and functionally complete and capable of delivery of electrical energy to the Interconnection Point.
- 1.41** “Substantial Completion Date” has the meaning set forth in Section 3.1 (*Substantial Completion; Final Completion*).
- 1.42** “Substantial Completion Notice” means that notice provided by Installer certifying that the System has achieved Substantial Completion.
- 1.43** “System” or “Systems” shall mean a battery energy storage system or battery energy storage systems identified in the applicable Work Authorization.
- 1.44** “Tenant” has the meaning set forth in Section 10.2 (*Acknowledgment and Consent of Tenant*).
- 1.45** “Work” has the meaning set forth in Section 2.1 (*Work*).
- 1.46** “Work Authorization” means a Work Authorization executed by the Parties with respect to a System that comprises the layout, specifications, description, Work, materials, Project Schedule, Permits,

---

Contract Price and all other information necessary to define the System and the Work with respect thereto.

- 1.47 “Work Product” has the meaning set forth in Section 10.16 (*Ownership of Designs*).
- 1.48 “Warranty” means the warranties provided in Appendix 2 of the applicable Work Authorization.

## 2. THE WORK.

- 2.1 **Work.** Installer shall provide, on a turnkey basis, all professional design and engineering services, equipment procurement, supervision, labor, materials, equipment, tools, construction equipment and machinery, utilities, transportation, and procurement of Installer Permits for the System (subject to the limitations set forth herein and the applicable Work Authorization) in conformity with a Work Authorization executed in accordance with this Agreement (the “Work”), and other facilities, items and services, in each case to the extent necessary to complete the Work in accordance with the Specifications. Installer shall have sole control over the engineering, design and construction means, methods, techniques, sequences, and procedures and for coordination of all portions of the Work unless otherwise provided herein.
- 2.2 **Design.** Installer shall perform engineering and design services, using qualified architects, engineers and other professionals selected by Installer, in each case as are necessary to prepare the Design Submittal. Each Design Submittal shall be submitted to Customer for approval, which shall not be unreasonably withheld. Customer shall review and provide its written approval of any Design Submittal in accordance with the Project Schedule, but in no event later than seven Days from receipt by Customer of the Design Submittal. If Customer fails to provide approval, objections and/or comments within such seven Day period, the Design Submittal may, at Installer’s option, be deemed approved by Customer. Installer shall incorporate or respond to Customer’s comments in conformity with the Project Schedule or as appropriate under the circumstances. Once the design has been approved or deemed approved by Customer, any additional Customer requested changes to the design or materials to be incorporated into the System will be handled as a Change Order and subject to modifications to Contract Price and Project Schedule as appropriate.
- 2.3 **Testing.** Upon Substantial Completion with respect to each System, Installer shall test the System, including all components thereof in accordance with any requirements set forth in the applicable Work Authorization.
- 2.4 **Project Schedule.** With respect to each System, Installer shall use its commercially reasonable efforts to perform the Work in conformity with the Project Schedule. Installer will provide notice to the Customer of the date it will commence work on the Site and shall consult with Customer regarding any issues that might arise as a result of Installer's work on Site.
- 2.5 **Compliance.** Installer shall cause the Work to be performed in compliance with Applicable Law and any design and engineering or other professional services to be performed pursuant to this Agreement and any Work Authorization, which under Applicable Law must be performed by licensed personnel, shall be performed by licensed personnel in compliance with Applicable Law. Installer shall obtain Payment and Performance Bonds and provide proof of same to the Customer prior to the commencement of the Work. Installer shall also comply with an applicable prevailing wage.
- 2.6 **Rebate Program/Tax Credits.**
- a. Installer shall provide reasonable assistance and cooperation to Customer in the preparation and submittal of any and all applications or other documentation necessary for Customer to participate in any Rebate Program. Installer shall attend all site verification visits conducted by the applicable public utility or Governmental Authority and shall assist

---

Customer in satisfying the requirements of the Rebate Program. Installer's obligations under this Section shall expire on the first anniversary of Substantial Completion of the System unless this Agreement is terminated earlier in accordance with the terms hereof.

- b. The Parties acknowledge and agree that any rebates or incentives payable under any Rebate Program or any tax credits associated with the ownership of the System will be paid directly to, or shall be retained by, Customer. Installer makes no representation or warranty as to the amount or availability of any Rebate Program or tax credit or incentive or any other incentives or credits available or perceived or believed to be available from any utility, Governmental Authority, or any other Person, and assumes no responsibility or liability in connection therewith. Customer shall be solely responsible for determining the availability of any Rebate Program and negotiating the payment of any such rebates with the applicable public utility or Governmental Authority.

## 2.7 Change Orders.

- a. **Generally.** Each Party may, upon Notice to the other Party, request a change to the Specifications, the Work, or any System by issuing a written order (the "Change Order") which shall include: (i) a reference to this Agreement and the relevant Work Authorization, (ii) the change to the Work and (iii) the effects (if any) of the Change Order on the Project Schedule and Contract Price.
- b. **Change Order Costs and Pricing.**
  - i. If a Change Order contemplates a change in Contract Price, but no change in the size (in MW) of the System, such changes shall be calculated as follows: (A) labor and materials costs of Installer shall be billed at cost, with a fifteen percent (15%) markup to cover administration, overhead and profit; (B) subcontractor costs of Installer shall be billed at cost, with a seven and a half percent (7.5%) markup to cover administration, overhead and profit; and (C) any additional performance or payment bond costs shall be billed at cost and not subject to markup.
  - ii. If a Change Order contemplates a change in Contract Price due to an increase in size (in MW) of the System, the Contract Price shall be proposed by Installer and agreed to by the Parties in accordance with this Section 2.7 (*Change Orders*).
- c. **Installer Requested Change Order.** Installer shall be entitled to a Change Order only upon the occurrence of any of the following:
  - i. any or all of the Work is delayed, suspended, or accelerated by Customer, its affiliates, or any of their employees, agents, contractors or representatives or any other person acting by, on behalf or through any of the foregoing (collectively, a "Customer Person");
  - ii. any breach by Customer or any Customer Person of the terms and conditions of this Agreement or the failure by any Customer Person to perform its obligations hereunder;
  - iii. a change in Applicable Law occurring after the Effective Date that affects Installer's performance hereunder and under the relevant Work Authorization;
  - iv. the occurrence of a Force Majeure Event;
  - v. any delays in obtaining Customer Permits or Installer Permits in excess of the times allotted for such Permit in the applicable Work Authorization; provided



## Oakland Unified School District

that Installer or Customer, as applicable, has (A) complied with all filing and application requirements and deadlines of the relevant Governmental Authority and (B) used commercially reasonable efforts to obtain such Permit, including, but not limited to, coordinating, and cooperating with the relevant Governmental Authority;

- vi. Work required or expenses or costs incurred as a result of or in connection with any of the exclusions set forth in this Agreement and in the applicable Work Authorization; and
  - vii. any change to the Specifications, the Work or the System requested by Customer's authorized representative appointed pursuant to Section 10.6 (*Authorized Representatives*).
- d. **Procedure.** If Installer is entitled to a Change Order pursuant to clause (c) above, Installer shall submit such Change Order to Customer for its review and approval, which shall not be unreasonably withheld. Within five Business Days, except for Change Orders identified by Installer as a critical priority to complete construction of the System in accordance with the Project Schedule (a "Critical Change Order"), after receipt of a Change Order, Customer shall either (i) execute and deliver such Change Order as provided by Installer or (ii) request that certain amendments or modifications be made to such Change Order. In the case of a Critical Change Order, the Parties agree to cooperate to promptly either (i) execute and deliver such Critical Change Order as provided by Installer or (ii) negotiate certain amendments or modifications to be made to such Critical Change Order in order to promptly execute such Change Order. If Customer does not respond to a Change Order requested by Installer within such five Business Day period, or sooner in the case of a Critical Change Order, then Work related to the Change Order will not be performed pending agreement on the scope of the Change Order and Installer shall be provided with an adjustment to the Project Schedule to the extent Installer has been delayed in its performance of the Work as a result of such delay in response. If Customer timely requests amendments or modifications to the Change Order, the Parties shall negotiate in good faith and shall promptly agree on and execute an amended Change Order. All executed or deemed executed Change Orders are hereby incorporated by reference into this Agreement and the applicable Work Authorization.
- e. **Equitable Adjustment.** If the Parties cannot agree on the cost or any other term or condition of a Change Order, then, (i) Installer shall have no obligation to implement the Change Order if such Change Order was requested by Customer, and (ii) if such Change Order has been requested by Installer and the Parties have not agreed on cost or any other term or condition of the requested Change Order, Installer shall have no obligation to implement such Change Order but Installer shall continue to perform the Work unrelated to such Change Order. Installer may, nevertheless, continue performance of the Work and shall have the right, upon completion of the Work, to submit an equitable adjustment claim to Customer for any additional amounts due to Installer as a result of any changes to the Work pursuant to clause (c) above. The Parties shall negotiate in good faith such equitable adjustment claim; provided, that Installer shall not be eligible to an equitable adjustment if the reason for the Change Order for which Installer requests an equitable adjustment is due to Installer's errors or omissions or breach of this Agreement. If the Parties are unable to reach agreement on an equitable adjustment, either party may exercise any remedies available to Installer under this Agreement or Applicable Law.
- 2.8 Work Site Supervision and Safety.** Installer shall supervise and direct all Work performed hereunder and shall be solely responsible for and have exclusive control over the means, methods, techniques, sequences, and procedures employed. Installer shall ensure that all persons performing work hereunder are skilled in the tasks assigned to them. Installer shall keep each Site reasonably

free of materials and accumulation of waste caused by the Work. Upon Substantial Completion of a System, Installer shall remove from the Site all waste, tools and equipment introduced to the Site by Installer (other than tools and equipment required for completion of the Punch List). Notwithstanding the foregoing, Installer shall comply with the terms of the Local Business Utilization Policy and the Project-Labor Agreement.

- 2.9** **Delay.** If Installer's performance hereunder is delayed by any event or circumstance described in clause (c) of Section 2.7 (*Change Orders*), Installer shall not be deemed in breach of this Agreement and shall be entitled to a Change Order in accordance with Section 2.7 (*Change Orders*). Installer shall use reasonable diligence to avoid or minimize the cause of such delay and shall, as soon as practicable, notify Customer thereof.
- 2.10** **Hazardous Materials.** Installer shall have no responsibility for detection, abatement, remediation, removal, or disposal of any Hazardous Material, except Hazardous Materials introduced onto the Site by Installer, its employees, subcontractors, agents, or other parties acting on behalf of Installer. In the event that Installer becomes aware of the presence of, or exposure of persons to, any Hazardous Material at the Site, Installer shall inform Customer by Notice as soon as practicable. Notwithstanding anything to the contrary herein, Installer shall not be responsible for, and Customer shall bear full responsibility and remediation costs relating to any Hazardous Materials uncovered, removed, or disturbed by Installer on the Site resulting from Installer's performance of the Work hereunder. In addition, Customer hereby specifically agrees to indemnify, defend and hold Installer, its present and future direct or indirect parents, subsidiaries, affiliates, divisions, and their respective directors, officers, employees, shareholders, agents, representatives, successors and assigns harmless from and against any and all losses, liabilities, claims, demands, damages, causes of action, fines, penalties, costs and expenses (including, but not limited to, all reasonable consulting, engineering, attorneys' or other professional fees), that they may incur or suffer by reason of: (a) the existence, uncovering or unveiling, or any release by Customer of, a Hazardous Material on or from the Site; (b) any enforcement or compliance proceeding commenced by or in the name of any Governmental Authority because of an alleged, threatened or actual violation of any Applicable Law by Customer or because of the presence on the Site of Hazardous Materials not specifically introduced onto the Site by Installer; and (c) any action reasonably necessary to abate, remediate or prevent a violation or threatened violation of any Applicable Law by Customer.

### 3. COMPLETION AND ACCEPTANCE OF THE WORK.

- 3.1** **Substantial Completion; Final Completion.** If Installer has achieved Substantial Completion or Final Completion with respect to a System, Installer shall deliver to Customer a Substantial Completion Notice or Final Completion Notice, as applicable, stating that such System achieved Substantial Completion or Final Completion, as applicable. Customer shall inspect, during a joint walkthrough with Installer on the Site, all Work within five Business Days from receipt of such Notice and either:
- a. deliver to Installer the Substantial Completion Notice or Final Completion Notice, as applicable, countersigned by a duly authorized officer of Customer confirming that Installer has completed the relevant Work; or
  - b. notify Installer that the relevant Work has not been completed, stating in detail the reasons therefor.

If Customer fails to inspect the Work and notify Installer that the relevant Work has not been completed within such five Business Days or if Customer delivers the countersigned Substantial Completion Notice or Final Completion Notice, as applicable, the Work shall be deemed accepted by Customer as of the date Installer first delivered such Notice (with respect to Substantial Completion Notice, the "Substantial Completion Date," and with respect to Final Completion Notice, the "Final Completion Date"). If Customer timely notifies Installer that the relevant Work



---

has not been completed, Installer shall take action to complete the relevant Work and shall deliver to Customer another Substantial Completion Notice or Final Completion Notice, as applicable. This procedure shall be repeated until the relevant Work shall have been accepted or deemed accepted by Customer.

**3.2 Punch List.** Upon achieving Substantial Completion with respect to a System, Installer shall provide Customer with a list of items still outstanding which are necessary to complete the System in accordance with the Specification (the “Punch List”). The Punch List shall include a schedule of values assigned to each item on the Punch List. Within five Business Days after receipt of a proposed Punch List, Customer shall either (a) approve the Punch List; or (b) request that certain amendments or modifications be made to the Punch List. If Customer does not request any amendments or modifications to the Punch List provided by Installer within such five Business Day period, Customer shall be deemed to have accepted, executed and delivered such Punch List and Customer hereby expressly agrees to be bound therewith. If Customer timely requests amendments or modifications to the Punch List, the Parties shall negotiate in good faith and shall promptly agree on and execute an amended Punch List. The Parties’ agreement on the Punch List shall not be a pre-requisite to the relevant System achieving Substantial Completion and the Parties’ failure to timely agree on the Punch List pursuant to this Section shall not delay or be deemed to preclude any System from achieving Substantial Completion hereunder.

**3.3 Final Completion.** Final Completion shall occur when Punch List Items are completed. The Punch List shall be created in accordance with Section 3.2 (*Punch List*) above and shall be completed in a mutually agreed time period not to exceed four months after Substantial Completion of the applicable System. If Installer fails to complete the Punch List items on or before the expiration of the four-month period set forth above (or such longer or shorter period as may be agreed upon by the Parties in writing), Customer may complete such remaining Punch List items on its own and charge Installer for the duly justified and reasonable costs. Installer shall promptly issue a Final Completion Notice upon completion by Installer of the Punch List items in accordance with Section 3.1 (*Substantial Completion; Final Completion*), and in no event later than the expiration of the period set forth above.

#### **4. CONTRACT PRICE; PAYMENTS.**

**4.1 Contract Price.** The Contract Price with respect to a System (the “Contract Price”) shall be stated in the applicable Work Authorization. The Contract Price may be adjusted by Change Orders or as otherwise provided herein.

**4.2 Payments of the Contract Price.** Customer shall pay the Contract Price to Installer in monthly installments (each a “Progress Payment”) for the portion of the Work performed during the previous month, which, in the case of each Progress Payment, shall be calculated by multiplying (a) the portion of Work completed by Installer during such month *times* (b) the percentage of Contract Price allocated to such Work in the Schedule of Values *times* (c) the Contract Price. Customer may retain 5% of the value of each Progress Payment (in aggregate, the “Retention”) and, upon Final Completion Customer shall release such Retention and pay to Installer an amount necessary to cause the total amounts paid to Installer hereunder to equal the Contract Price.

**4.3 Invoices.** Installer shall submit to Customer an invoice together with all supporting documentation for each Progress Payment due hereunder. Submission of an invoice shall constitute a representation by Installer that the portion of the Work subject to such invoice has been performed in accordance with this Agreement and the applicable Work Authorization. Customer shall pay each invoice within 30 Days from the date of such invoice.

**4.4 Disputed Invoices.** If Customer disputes any invoice or any portion thereof, Customer shall give Installer Notice of such dispute within 15 Days after receipt of such invoice and shall nevertheless timely pay the undisputed portion of such invoice in accordance with Section 4.3 (*Invoices*). If

---

Customer fails to dispute an invoice within such 15 Day period, Customer shall be deemed to have accepted such invoice in full. Upon receipt by Installer of a timely dispute Notice, the Parties shall meet and attempt to resolve such dispute amicably. Upon resolution of any disputed amount, the agreed-upon amount shall be paid within 15 Days after resolution of the dispute. Any dispute not resolved amicably hereunder may be submitted to arbitration in accordance with the terms of Section 10.13 (*Arbitration*). Customer shall not be deemed to be in default of this Agreement by reason of withholding payment with respect to any portion of an invoice disputed in good faith; provided, that if such dispute is resolved in Installer's favor, Customer shall pay interest on such unpaid amounts dating back to the original due date set forth in the applicable invoice. Any payment not received on or before the due date for such payment, shall bear interest at the rate of 2% above the rate per annum quoted in the Wall Street Journal as the prime rate for corporate loans (or the arithmetic mean if there is more than one such rate), or the highest rate allowable by law, whichever is lower, commencing on the first Day after such payment is due and continuing until paid.

- 4.5 Payment to Subcontractors and Suppliers.** Upon payment by Customer of any invoice, Installer shall promptly pay its relevant subcontractor and supplier amounts due with respect to the Work reflected in the invoice. Installer shall be responsible to keep the Site clear and free from all liens placed on the Site by any subcontractor or supplier or Installer with respect to Work paid for by Customer, and to defend, discharge or bond any such liens as soon as reasonably practicable.
- 4.6 Title.** Title to the System shall pass to Customer during the course of construction and upon payment to Installer of Progress Payments related to the installation or delivery to the Site of such equipment or materials, including, without limitation, the battery packs, inverters, materials, and equipment, subject in each case to the extent payment thereof shall have been made by Customer in accordance with this Agreement and the applicable Work Authorization.
- 4.7 Risk of Loss.** From the Effective date and until the Substantial Completion Date of a System, Installer assumes risk of loss and full responsibility for the cost of replacing or repairing any damage to such System and all materials, equipment, supplies and maintenance equipment (including temporary materials, equipment and supplies) that are purchased by Installer for permanent installation in or for use during construction of such System, regardless of whether Customer has title thereto under this Agreement. Customer shall bear the risk of loss and full responsibility in respect of a System from and after the Substantial Completion Date of a System, and if any component of such System is lost or damaged for whatever reason, then Installer shall restore or rebuild any such loss or damage and complete the Work in accordance with this Agreement at the sole cost and expense of Customer. Notwithstanding the foregoing:
- a.** Installer shall not be obligated to restore or rebuild any such loss or damage unless Customer has obtained and maintained the insurance that Customer is required to maintain pursuant to Section 7.1 (*Customer's Insurance*) and Installer has received reasonable assurances from Customer that Customer will prosecute such claim in a commercially reasonable manner and Installer will receive the insurance proceeds, if any, paid under such Customer-maintained insurance policy in accordance with the disbursement provisions of this Agreement; and
  - b.** Save as set forth elsewhere in this Agreement, Customer shall bear the risk of loss and full responsibility for the cost of replacing or repairing any damage to such System and all materials, equipment, supplies and maintenance equipment (including temporary materials, equipment and supplies) that are purchased by Installer or Customer for permanent installation in or for use during construction of such System to the extent caused by the negligent, grossly negligent or willful acts of Customer or its agents, employees or representatives.

---

**5. TERM.**

- 5.1 Generally.** This Agreement shall commence on the Effective Date and shall continue for a period of one year, unless sooner terminated pursuant to this Agreement. This Agreement may be renewed for additional one-year periods through mutual written agreement between the Parties. The initial term and each renewal term, if any, are collectively referred herein as the “Term.”
- 5.2 Work Authorization Term.** The term of each Work Authorization executed hereunder shall commence as of the effective date of such Work Authorization and shall continue until the Final Completion of the System or Systems set forth in such Work Authorization. Termination or expiration of this Agreement shall not relieve the Parties from their respective obligations with respect to any System for which a Work Authorization was executed prior to such expiration or termination.
- 5.3 Termination For Cause.** Either Party may terminate this Agreement for cause if the other Party Materially Breaches this Agreement and the breaching Party does not take action to cure such breach within 15 Business Days after Notice thereof; provided, that if the relevant Material Breach cannot reasonably be cured within the time period set forth above, such 15 Business Day period shall be extended as may reasonably be required so long as the breaching Party continues to exercise its good faith reasonable efforts to cure such breach. “Material Breach” shall mean a default in one Party’s obligations hereunder or under a Work Authorization that substantially undermines the economic value of this Agreement to the other Party.
- 5.4 Installer’s Rights and Remedies.** Notwithstanding the preceding Section 5.3 (*Termination for Cause*), if Customer (i) fails to pay any amount payable to Installer after it becomes due and payable to Installer under this Agreement and after the processes of Section 4.4 and 10.13 have concluded or (ii) is insolvent, adjudged bankrupt or makes a general assignment for the benefit of its creditors, then Installer may pursue any of the following rights and remedies:
- a.** Upon three Days’ written Notice to Customer, suspend all Work until any such default is cured; and
  - b.** Upon ten Days written Notice to Customer, terminate this Agreement and recover the following amounts from Customer: (i) all amounts due from Customer for services provided and materials purchased through the date of termination, (ii) all costs of winding down the System, removing materials and supplies from the Site and terminating subcontractors and any material purchase orders, and (iii) any other rights or remedies available to Installer at law, in equity or under this Agreement.

**6. INDEMNITY.**

- 6.1 Indemnification by Installer.** Installer shall defend, indemnify and hold harmless Customer, its officers, directors, employees and agents from and against any third party claims, demands, damages, losses, fees, expenses, liabilities and penalties (including, without limitation, reasonable attorneys’ fees), arising from personal injury or property damage claims, caused by Installer or its performance or nonperformance under this Agreement; provided, however, in no event will Installer be responsible for any such claims, losses, damages, injuries, and liabilities to the extent caused by Customer, third parties or other causes beyond Installer’s control; provided further that to the extent Customer recovers such damages, losses and expenses under any insurance policy, Customer shall reimburse any payment made by Installer under this indemnity.
- 6.2 Indemnification by Customer.** Customer shall defend, indemnify and hold harmless Installer, its officers, directors, employees and agents from and against any claims, demands, damages, losses, fees, expenses, liabilities and penalties (including, without limitation, reasonable attorneys’ and expert witnesses’ fees), arising from personal injury, payment, or property claims caused by

Customer out of or relating to Customer's performance or nonperformance under this Agreement, provided, however, in no event will Customer be responsible for any such claims, losses, damages, injuries, and liabilities to the extent caused by Installer, third parties or other causes beyond Customer's control; provided, however, in no event will Customer be responsible for any such claims, losses, damages, injuries, and liabilities caused by Installer, third parties or other causes beyond Customer's control; provided further that to the extent Installer recovers such damages, losses and expenses under any insurance policy, Installer shall reimburse any payment made by Customer under this indemnity.

- 6.3** **LIMITATION OF LIABILITY. IN NO EVENT WILL EITHER PARTY BE LIABLE TO THE OTHER PARTY UNDER THIS AGREEMENT OR OTHERWISE FOR INDIRECT, INCIDENTAL, SPECIAL, CONSEQUENTIAL OR EXEMPLARY DAMAGES ARISING OUT OF OR RELATED TO THIS AGREEMENT, INCLUDING BUT NOT LIMITED TO SUCH DAMAGES THAT ARE LOST PROFITS, COSTS OF PROCUREMENT OF SUBSTITUTE GOODS OR SERVICES, BUSINESS INTERRUPTION, EVEN IF THE PARTIES HAVE BEEN ADVISED OF THE POSSIBILITY OF SUCH DAMAGES. IN ADDITION, WHETHER ANY ACTION OR CLAIM IS BASED ON WARRANTY, CONTRACT, AND TORT OR OTHERWISE, UNDER NO CIRCUMSTANCES SHALL EITHER PARTY'S TOTAL LIABILITY ARISING OUT OF OR RELATED TO THIS AGREEMENT EXCEED THE TOTAL AMOUNT PAID BY CUSTOMER TO INSTALLER UNDER THE APPLICABLE WORK AUTHORIZATION.**

## **7. INSURANCE.**

- 7.1** **Customer's Insurance.** Customer shall procure and maintain general liability insurance. Limits of liability will be maintained at \$1,000,000 per occurrence/\$2,000,000 annual aggregate. Coverage will include Products Completed Operations, Personal/Advertising Injury, and medical expense of \$10,000. Insurance shall name Installer as an additional insured. Customer shall provide Installer a certificate of insurance evidencing the insurance required in this Section upon request.
- 7.2** **Installer's Insurance.** Installer shall maintain (a) comprehensive commercial general liability insurance, (b) installation or builders' risk insurance, (c) workers' compensation insurance for Installer's employees and (d) automobile liability insurance. Installer shall provide Customer a certificate of insurance evidencing the insurance required in this Section 7.2 upon request.
- a.** Commercial General Liability: Limits of liability will be maintained at \$1,000,000 per occurrence/\$2,000,000 annual aggregate. Coverage will include Products Completed Operations, Contractual Liability, Property Damage, and Personal Injury. This insurance will also name Customer as an additional insured.
  - b.** Installation or Builders' Risk Insurance: Will cover the System and all materials from the time delivered to the Site for their full replacement cost value on an all risk or special cause of loss form from the Commencement Date through the Substantial Completion Date. Insurance shall be in a form and include deductible levels typically found in the insurance market for similar solar projects. This insurance shall name Customer as an additional insured.
  - c.** Workers' Compensation: Statutory as described by law and employers' liability at limits of \$1,000,000.
  - d.** Automobile Liability: Limits will be maintained at \$1,000,000 combined single limit per occurrence for bodily injury and property damage. Insurance shall cover owned, non-owned, and hired autos.

If Installer fails to secure and maintain the required insurance, Customer shall have the right (without

any obligation to do so, however) to secure the same in the name and for the account of Installer, in which event Installer shall pay the reasonable cost thereof (or Customer may deduct the same from amounts otherwise due Installer hereunder) and Installer shall furnish upon demand all information that may be required in connection therewith.

**8. REPRESENTATIONS AND WARRANTIES.** Each Party hereby represents and warrants to the other party as follows:

**8.1 Organization and Qualification.** It is duly organized, validly existing and in good standing under the laws of the jurisdiction of its organizations and has the lawful power to engage in the business it presently conducts and contemplates conducting.

**8.2 Power and Authority.** It has the power to make and carry out this Agreement and each Work Authorization executed hereunder and to perform its obligations hereunder and under each Work Authorization and all such actions have been duly authorized by all necessary proceedings on its part.

**8.3 No Conflict.** The execution, delivery and performance of this Agreement and each Work Authorization will not conflict with, result in the breach of, constitute a default under or accelerate performance required by any of the terms of its certificate of incorporation or by-laws or any Applicable Law or any covenant, agreement, understanding, decree, or order to which it is a party or by which it or any of its properties or assets is bound or affected.

**8.4 Validity and Binding Effect.** This Agreement and each Work Authorization has been or will be at the time executed or deemed executed, duly and validly executed, and delivered by it and constitutes its legal, valid, and binding obligation, enforceable in accordance with its terms, except to the extent that its enforceability may be limited by bankruptcy, insolvency, reorganization, moratorium, or other similar laws affecting the rights of creditors generally or by general principles of equity.

**9. CUSTOMER'S RESPONSIBILITIES.**

**9.1 Access to Site.** On the Commencement Date of any System and for so long as any Work (including any Work related to the Warranty) is provided by Installer hereunder, Customer shall enable Installer or any of its subcontractors or agents to gain free, unobstructed, access to the Site for the purpose of performing the Work hereunder and shall keep the Site free and clear from any encumbrances, obstructions or Hazardous Materials introduced to the Site by Customer. In addition to the foregoing, Customer shall allow Installer to have access to the Site to: (a) inspect the Site to verify conditions and to construct and install the System on the Site; (b) to access and maintain a data acquisition system ("DAS") on the System and collect data from such DAS, independent of any DAS owned by Customer; and (c) to perform (or cause to be performed) all tasks necessary or appropriate, as reasonably determined by Installer, to carry out the activities and enjoy the rights set forth in this Agreement. Customer shall ensure that Installer has access to and use of lighting, power, and water while performing Work hereunder at no cost to Installer. Customer shall be responsible for making arrangements with Host and/or Tenant, if necessary, for the provisions required by this Section.

**9.2 Customer Permits.** Unless otherwise provided in the relevant Work Authorization, Customer shall provide all Customer Permits.

**9.3 Compliance with Laws and Agreements.** Customer shall comply with any express or implied obligation required at law or in equity or under any Permits, Interconnection Agreements, financing documents or other agreements or understandings to which Customer or any Customer Person are a party or under which any of them are bound that would have an effect on this Agreement or Customer's or Installer's obligations hereunder.



## Oakland Unified School District

- 9.4 Cooperation.** Customer shall fully and timely cooperate with Installer in Installer's performance of its obligations under this Agreement, including, without limitation, (a) timely review and, where applicable, approve drawings, specifications, Change Order requests and other Installer requirements, (b) timely negotiate and execute Interconnection Agreements and timely provide all information and consents necessary for Installer to apply for the Installer Permits and fulfill its obligations hereunder, (c) comply with the Project Schedule as it applies to Customer and (d) perform or cause to be performed any work, or pay or caused to be paid any amount, required hereunder in connection with any exclusion set forth herein.
- 9.5 Site Preparation.** Prior to commencement of the Work, Customer shall be responsible for any necessary Site preparation and correction.
- 9.6 Data Transmission.** Where required, Customer shall cause to be installed a TCP/IP or telephone connection for data transmission and shall maintain such connection throughout the applicable Warranty Term.
- 9.7 Storage.** Customer shall provide Installer with an area for storage space located near the Site for storage of materials, tools and equipment, and other purposes.
- 10. MISCELLANEOUS**
- 10.1 [Intentionally Omitted].**
- 10.2 [Intentionally Omitted].**
- 10.3 Notices.** All Notices required or permitted hereunder shall be in writing and shall be deemed given: (a) when delivered in person; (b) the next Business Day after deposit with a commercial overnight delivery service for next day delivery; or (c) upon receipt if sent by United States mail, postage prepaid, registered, or certified mail, return receipt requested. All Notices shall be addressed to the recipient party at the address set forth on the first page to this Agreement or other address a party may designate in writing from time to time.
- 10.4 Independent Contractor.** Installer shall at all times be and remain an independent contractor and not an agent of Customer for any purpose whatsoever and shall have no authority to create or assume any obligation, express or implied, in the name of or on behalf of Customer or to bind Customer in any manner whatsoever.
- 10.5 Subcontractors.** Installer may from time to time retain third party subcontractors and suppliers in connection with the Work or any System provided hereunder.
- 10.6 Authorized Representatives.** Each Party shall designate one or more representatives authorized to act on behalf of the designating Party. If a Party designates more than one authorized representative, it shall specify the nature of the communications for which each representative is authorized to act on the designating Party's behalf.
- 10.7 Publicity/Signage.** Installer shall have the right to: (a) with reasonable notice, to access the System with guests for promotional purposes, including the taking photographs, during normal open hours and at other times as are acceptable to the Customer in its reasonable business judgment; and (b) place a SunPower-designed sign, containing the logos of the Parties, on or near the Site and easily visible to public during and after the installation of the System for the life of the System, with dimensions between 4'x3' and 8'x6'.
- 10.8 Entire Agreement; Amendment.** This Agreement, including the Exhibits hereto and any signed Work Authorization hereunder, represents the entire and integrated agreement between the parties hereto with respect to the subject matter hereof and supersedes all prior negotiations,

---

representations, or agreements, either written or oral. No Amendment, modification, or waiver in respect of this Agreement will be effective unless in writing and executed by both Parties.

- 10.9** **Assignment.** Neither Party shall assign or delegate its rights or obligations under this Agreement without the written consent of the other Party. In determining whether to consent to any assignment, each Party shall be entitled to consider the experience, reputation and creditworthiness of the proposed assignee or other transferee. Subject to the foregoing, this Agreement shall be binding on and shall inure to the benefit of the Parties and their respective successors and assigns.
- 10.10** **No Waiver.** No failure on the part of either Party to exercise or enforce any term hereof or any right hereunder shall operate as a waiver, release, or relinquishment of any right or power conferred under this Agreement.
- 10.11** **Survival.** Cancellation, expiration, or earlier termination of this Agreement shall not relieve the Parties of obligations that by their nature should survive such cancellation, expiration, or termination (including, without limitation, any representations, or warranties).
- 10.12** **Governing Law.** This Agreement with respect to each System shall be governed by, interpreted, and enforced in accordance with, the laws of the State of California.
- 10.13** **Arbitration.** All disputes arising under, out of, or relating to this Agreement shall be settled by binding arbitration by the American Arbitration Association (“AAA”) by a single arbitrator under the Commercial Arbitration Rules of the AAA in force as of the date the AAA receives notice of such claim or dispute. The substantially prevailing Party shall be entitled to recovery of its reasonable attorney’s fees and arbitral costs. The language of arbitration shall be English. The place and seat of arbitration shall be San Francisco, CA. The Parties hereto expressly agree to the joinder of any arbitral proceedings hereunder together with any other arbitral proceedings as deemed necessary and proper by the arbitrator.
- 10.14** **Expert Determination.** For disputes concerning the determination of (i) the proposed content of the Punch List or the value of a Punch List item; or (ii) the valuation of any Change Order; or (iii) the interpretation of any applicable engineering codes or standards, either Party may submit a notice of the dispute to the other Party together with the name of a proposed independent engineer (an “Independent Expert”), which shall be any of the Persons listed on Exhibit E hereto or any other such independent engineer as may be agreed by the Parties, who shall resolve the dispute. The dispute shall be submitted to such Independent Expert and the resolution of such dispute shall be subject to the following requirements and procedures: (a) the notice to the responding party shall include a description of the dispute and the grounds and documents on which the claiming party relies in seeking to have the dispute determined in its favor. The responding party, within five (5) Business Days after receipt of such notice shall deliver to the claiming party and the Independent Expert a response setting forth the grounds and documents on which the responding party relies in seeking to have the dispute determined in its favor; and (b) the Independent Expert shall render his/her written decision on the dispute (the “Expert Determination”) as soon as possible, but in any event, shall endeavor to render the Expert Determination no later than ten (10) Business Days following the submission of the dispute to the Independent Expert, without regard to whether the responding party submits its response. The Expert Determination shall be contractually binding upon the Parties. The Independent Expert shall provide the Parties with a copy of the Expert Determination, which Expert Determination must include a concise written statement of the reasons on which it is based. Any fees or expenses charged by the Independent Expert in connection with the resolution of any such dispute shall be borne equally by the Parties. To avoid all doubt, the Independent Expert is not, and may not be deemed, an arbitrator of the matters in dispute and may not be deemed to be acting in an arbitral capacity or conducting arbitral proceedings. Moreover, the Expert Determination is not an arbitral award.



## Oakland Unified School District

- 
- 10.15 Execution in Counterparts.** This Agreement may be executed in counterparts, each of which shall be deemed an original, but all of which shall constitute one and the same instrument.
- 10.16 Ownership of Designs.** All drawings, specifications, calculations, data, notes and other materials and documents, including electronic data furnished by Installer to Customer under this Agreement (“Work Product”) are the instruments of service of Installer and Installer will retain all common law, statutory and other reserved rights, including copyrights.
- 10.17 Final Drawings/Manuals.** Upon Final Completion and Customer’s payment in full for all Work performed under this Agreement, Installer shall deliver to Customer a copy of the final record drawings for the System and all operation and maintenance manuals with respect to the System.
- 10.18 Customer’s Limited License Upon Payment in Full.** Upon Customer’s payment in full for all Work performed under this Agreement, Installer will grant Customer, and its successors and assigns a perpetual, royalty-free limited license to use the Work Product in connection with Customer’s operation, maintenance, and repair of the System. The Parties agree that the limited license to use the Work Product granted hereunder will provide Customer sufficient rights in and to the Work Product as will be necessary for Customer to operate and maintain the System. The license granted under this Section is only valid for use in relation to the System and this provision does not permit Customer to use Installer’s intellectual property in relation to any other project or photovoltaic system. No other license in the Work Product is granted pursuant to this Agreement.



# SUNPOWER

## Oakland Unified School District

IN WITNESS WHEREOF, in consideration for the mutual promises set forth in this Agreement and for other good and valuable consideration, the receipt and sufficiency of which are hereby acknowledged, the undersigned have executed this Agreement by their duly authorized representatives as of the date first written above.

**SUNPOWER CORPORATION, SYSTEMS**

**OAKLAND UNIFIED SCHOOL DISTRICT**

By: Frederic A Potts III

By: Tadashi Nakadegawa

Name: Eric Potts

Name: Tadashi Nakadegawa

Title: Vice President

Title: Deputy Chief of Facilities Planning and Management

Shanthy Gonzales

12/16/2021

Shanthy Gonzales,  
President, Board of Education

Date

Kyla Johnson-Trammell

12/16/2021

Kyla Johnson-Trammell,  
Secretary & Superintendent, Board of Education

Date

Approved As to Form:

Eric Potts



---

**EXHIBIT A**
**WORK AUTHORIZATION AND SCOPE OF WORK FOR: OAKLAND HIGH SCHOOL**

<b>SUNPOWER CORPORATION, SYSTEMS</b> ("Installer")	<b>OAKLAND UNIFIED SCHOOL DISTRICT</b> ("Customer")
<b>Installer Address and Contact</b>	<b>Customer Address and Contact</b>
1414 Harbour Way South, Richmond, CA, 94804	1023 MacArthur Blvd., Oakland, CA 94610
<b>Effective Date:</b> December 16, 2021	

This Work Authorization (this "Work Authorization") is entered into between Installer and Customer and made effective as of the Effective Date set forth above. This Work Authorization is made part of the Engineering, Procurement and Construction Agreement between Customer and Installer, dated as of December 16, 2021 (the "Agreement"). Capitalized terms used in this Work Authorized but not specifically defined herein shall have the meaning given to such terms in the Agreement.

**1. SYSTEM LOCATION AND DESCRIPTION:**

- 1.1** Address: 1023 MacArthur Blvd., Oakland, CA 94610  
 System Size Product and Basic Description: Tesla Megapack 1 Battery Energy Storage System – 407.7 kW/ 1630.8 kWh (or similar)

Site Description and System Array are provided on Appendix 1 to this Work Authorization.

**2. CONTRACT PRICE:**

<b>2.1</b>	Battery Energy Storage System/Installed	\$1,438,735.
<b>2.2</b>	Data Acquisition System	Included
<b>2.3</b>	Owner's Manual	Included
<b>2.4</b>	Sales Tax	Included
	Contract Price:	\$1,438,735.

**3. SCHEDULE OF VALUES:** The schedule of value listed below is the estimated payment schedule as of the Effective Date and the Parties agree that the actual payment schedule may be adjusted based on mutual agreement of the Parties or based on the results of the Installer's credit review of Customer.

**STORAGE**

<b>Work Description</b>	<b>% of Contract Price</b>
PO Issued	30
Pad and infrastructure work installed	30
Elect Equipment Delivery and connection	30
Permission to Operation	5
Final Completion (Punch list)	5
	100%

**4. PROJECT SCHEDULE:**

Date:	Description:
12/9/2021	Customer issues Notice to Proceed to Installer
12/13/2021	Commencement Date
1/24/2021	Engineering Design Submittal Development
10/3/2022	Balance of System Delivered to Site (or Insured Warehouse)
10/31/2022	ESS Delivered to Site (or Insured Warehouse)
11/11/2022	ESS Module Installation Completed
11/11/2022	Electrical/Substantial Installation Completed
1/20/2023	Interconnection Approval (PTO)*
1/23/2023	Final Completion

\* Contingent on the PV system tie-in into the BESS switchgear being completed by others

**5. SCOPE OF WORK:**

**This scope of work includes the following description and assumptions. Should any of the assumptions or conditions vary any added cost will generate a Change Order in accordance with the Agreement.**

System Design & Scope***Equipment Location & Tie-In***

Battery Energy Storage System equipment such as the battery packs and inverters will be installed on a standard SunPower service concrete pad, located within 80 feet of the electrical tie-in location. Standard boring, without conflicts related to underground utilities, and use of EMT conduit with rain-tight compression fittings for above ground installations and schedule 40 PVC for below ground installations.

A security system is not included. Standard lightening protection is not included.

The System is designed for a Site that is not located in a flood zone or wash zone where flash flooding occurs.

***Fencing***

Permanent galvanized chain-link fencing, gates and lock boxes enclosing equipment (over and around) is included.

***ADA***

Accessibility design and upgrades are not included. Design assumes the California Green Building Standards Code is not applicable.

***Painting***

Materials are factory-finished or non-corrosive and will not need painting for weather protection or aesthetic reasons.

***Landscaping***

Site landscaping, including plant restoration, tree planting, or weed abatement, is not included.

Interconnection***Facility Equipment***

The System includes all standard interconnection related equipment on the Customer side of the meter, including panel circuit breakers, utility lockable disconnect switches, conduit, and wiring. Support with respect to the interconnection application, interconnection studies, engineering, design, and interconnection agreement is included. Installer's request for PTO is contingent on the PV system tie-in into the BESS switchgear being completed by others.

The System will interconnect at Customer's existing main panel and the panel is rated 480/277 Volts with ample current capacity to accept the System. The existing panel is assumed to have provisions to accept cable connections on the primary side of the main service breaker. Panel or bus bar reconfiguration is not included.

Foundations, Soil Conditions and Site Preparation***Soil Conditions***

The following foundation is assumed for the battery storage system: 8" thick, 4000 PSI, 25'x6.5' concrete pad. Actual foundation requirements will be determined upon completion of the engineering process.

Existing site soil is assumed to have the following characteristics (which will allow the use of standard foundations): (a) IBC or UBC Table 1804A.2, Class 3 or equivalent non-hazardous, sandy gravel and/or gravel; (b) allowable foundation pressure greater than or equal to 2000 psf and Lateral Bearing strength below grade equal to 200 (Lbs./Sq.Ft./Ft. of depth); (d) lateral sliding coefficient of friction greater than or equal to 0.35, with no sub-grade rocks or rock formations; (e) adequate drainage; (f) no seismic-related hazards (e.g. faults, liquefaction, seismically-induced settlement, lateral spreading); (g) limited expansiveness; (h) low to moderate corrosivity; and (i) depth to start of passive pressure is 0.5 feet.

***Slope Tolerance***

Slope of the battery storage system should be no more than 1% in any direction.

In addition to these localized maximum slope requirements, the overall site must be of a similar slope to avoid terracing or retaining work, which would be regarded as additional work and is not included in this scope of work. Any work that is required to accommodate site slopes in excess of the maximum shown above, whether additional preparation of the site by Installer, or alterations or additions to the battery energy storage system pad, is not included in this scope of work.

Commissioning

The battery energy storage system will be commissioned on site by a manufacturer's representative or qualified technician in accordance with the manufacturer's requirements and procedures.

Permitting and Construction***Permits***

<b>Permit</b>	<b>Installer Permit</b>	<b>Customer Permit</b>	<b>Cost Allocation</b>	<b>Allotted Time following Application</b>
Division of State Architect (DSA)	X		\$5,000	

Installer will assist Customer in obtaining the Customer Permits.

---

***Labor***

Prevailing wage is included. Overtime and special shift requirements are not included. Requirements for diversified or minority contractors are not included.

***Indirect Construction Costs***

Taxes or fees, other than sales tax, are not included. Payment and performance bonds are included.

Insurance requirements in excess of Installer's standard limits and coverages are not included. See Section 7 of the Agreement for the insurance requirements of Installer and Customer.

Additional design work to change Installer's CAD design standards to meet Customer's unique CAD or other electronic design or collaboration requirements are not included.

***Weather conditions***

Installer assumes standard weather patterns and site conditions for planning the Project Schedule. Instances of excessive climate, weather (greater than the most adverse conditions in the last 3 years) or natural disasters may result in delays and or unplanned costs (i.e., additional labor, shipping, storage, and logistics costs) which will be the responsibility of Customer.

**Customer Responsibilities/Assumptions of Site*****Access***

Existing roads will be capable of handling all required construction equipment such as drilling rigs, concrete trucks, delivery trucks, cranes, and all other equipment necessary to complete the work. Installer will not be responsible for any damage to existing roads resulting from normal construction operations. Construction of access roads, or modification of construction or delivery methods will require a Change Order.

Installer will have site access for construction activities and deliveries during all hours of the week. Installer will have 24/7 access to existing electric utility meter and the utility lockable disconnect location.

Extra time or personnel constraints due to site security beyond daily signing in by workers on a sign in sheet, i.e., badging, background checks, tool inventory checks, etc. is not included.

***Use of Facilities***

Installer assumes that onsite water and power will be available for construction with no restrictions and at no charge to Installer. Water source is within 50 feet of battery pad location.

***Unforeseen Site Conditions***

Unforeseen site conditions that require special handling are not included. Changes to design or construction as a result of utilities and or hazards, underground or above ground, or any undocumented site upgrades will require a Change Order. Changes to drainage are not included.

***Testing and Inspections***

Installer assumes all Special Inspections and Inspector of Record (IOR) shall be paid for and contracted by the Customer.

***Zoning***

Site is zoned for battery energy storage installation per Installer's design requirements. Re-zoning is not included in this scope of work. Time or costs associated with issues related to easements such as roads, bridges, utility power lines, etc, is not included in this scope of work.

***Utility Requirements***

Installer assumes that all utility-owned electrical equipment serving the facility has adequate capacity to handle the System output. Any costs associated with unforeseen utility interconnection requirements, including but not limited to utility-owned equipment upgrades or additions, relay protection equipment external to the inverters, and system impact studies are not included in this scope of work. Additional Customer-side protection required by the utilities above that provided by the certified inverters is not included.

# SUNPOWER\*

Oakland Unified School District

IN WITNESS WHEREOF, in consideration for the mutual promises set forth in the Agreement and for other good and valuable consideration, the receipt and sufficiency of which are hereby acknowledged, the undersigned have executed this Work Authorization by their duly authorized representatives as of the date first written above.

OAKLAND UNIFIED SCHOOL DISTRICT

SUNPOWER CORPORATION, SYSTEMS,  
a Delaware corporation

By:



Name: Tadashi Nakadegawa

By:



Name: Eric Potts

Title: Deputy Chief of Facilities Planning and Management

Title: Vice President

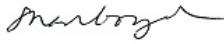

12/16/2021

Shanthi Gonzales,  
President, Board of Education

Date



12/16/2021

Kyla Johnson-Trammell,  
Secretary & Superintendent, Board of Education

Date

Approved As to Form:

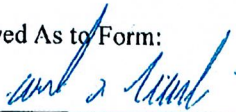

**1. SITE DESCRIPTION:**

- **Open recreation area just south of the high school building. The battery energy storage system will be located just east of the retaining wall where the outdoor tables are currently located.**
- **The Site is owned by Oakland Unified School District.**
- **The Site is covered by asphalt pavement or concrete.**
- **The Site is immediately bounded to the south by Park Blvd.; to the north by Alma Ave. and MacArthur Blvd.; to the west by South Loomis Street; and to the east by high school parking, Home Place East, and residential areas.**
- **The Site slopes from the northwest and main electrical pad down to the recreation area.**
- **The Site is not located within a 100- or 500-year flood plain.**

**2. SYSTEM ARRAY:**

[See attached.]



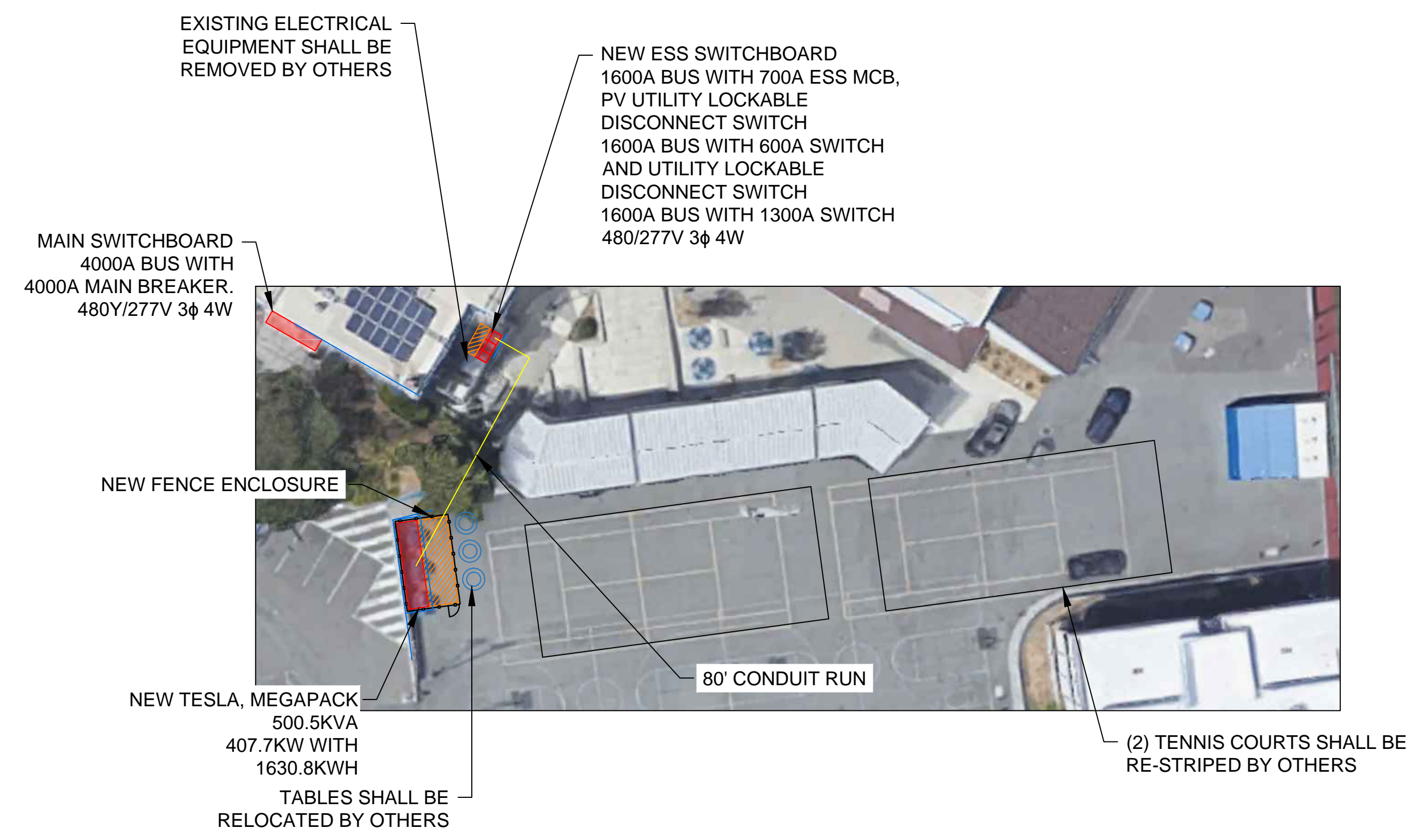
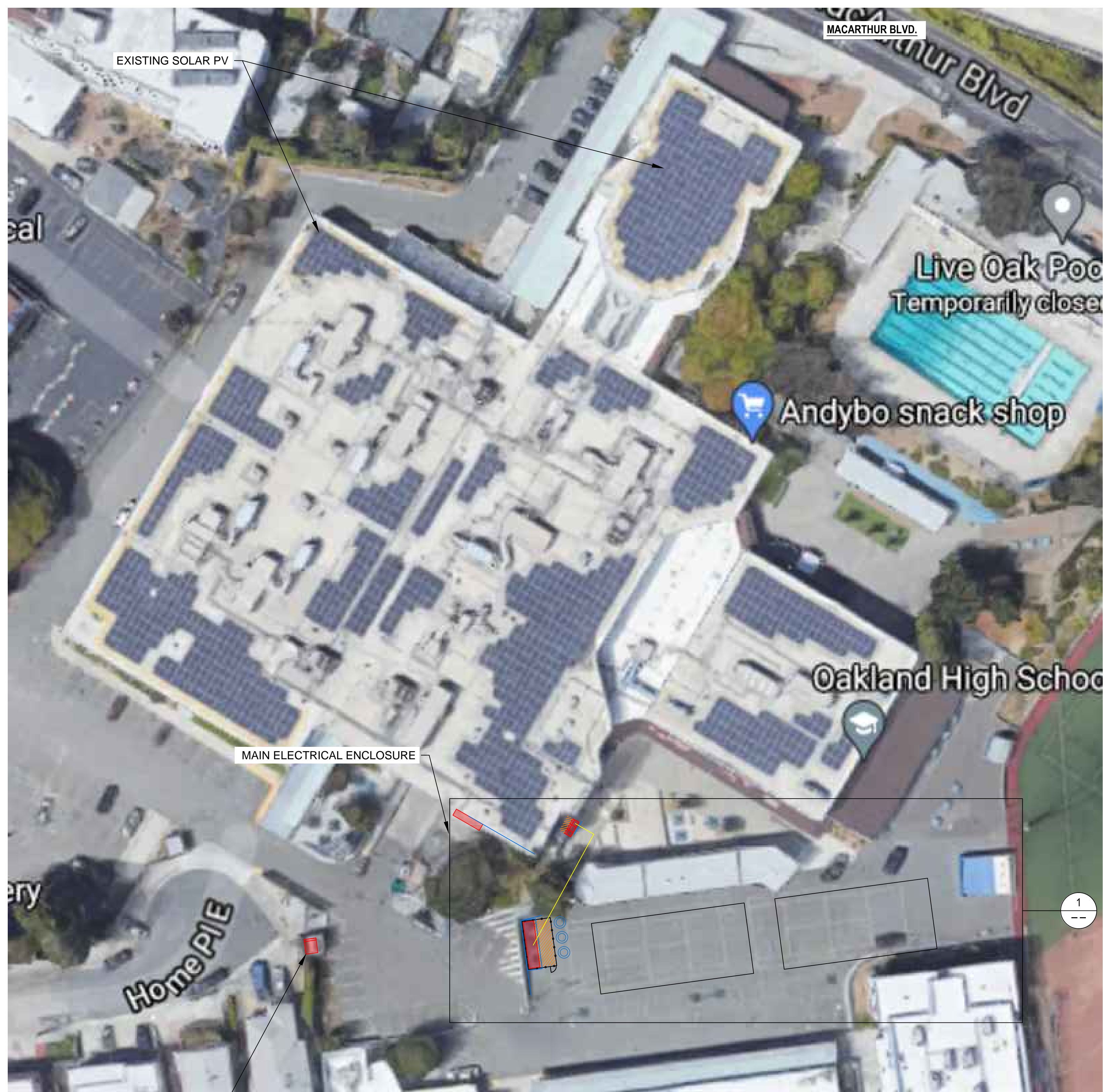
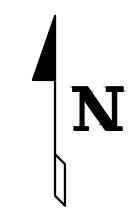

1 ELECTRICAL LAYOUT DETAIL  
SCALE: NTS

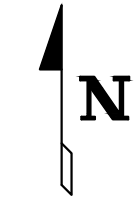

**SUNPOWER**

1414 HARBOUR WAY SOUTH  
RICHMOND, CA 94804 USA  
(510) 540-0550

THE COMPANY SHALL BE RESPONSIBLE FOR OBTAINING ALL NECESSARY PERMITS AND APPROVALS FROM THE LOCAL GOVERNMENT AND THE STATE OF CALIFORNIA. THE COMPANY SHALL BE RESPONSIBLE FOR THE SAFETY OF ALL PERSONNEL AND THE PUBLIC AT ALL TIMES.

**CONTRACTOR:**  
**ELITE ELECTRIC Inc.**  
9415 BELLEGRAVE AVE, RIVERSIDE, CA  
92509  
(951) 681-5811

**STAMP:**

**SHEET TITLE:**  
LAYOUT

**PROJECT:**  
OAKLAND USD  
OAKLAND HS  
1023 MACARTHUR BLVD.  
OAKLAND, CA 94610

**PROJECT NO.** 20-177  
**DATE** 05/13/2021  
**SCALE**  
**PERMIT**  
**DRAWN BY** JK

**REVISION NO.**  
△ \_\_\_\_\_  
△ \_\_\_\_\_  
△ \_\_\_\_\_  
△ \_\_\_\_\_  
△ \_\_\_\_\_  
△ \_\_\_\_\_

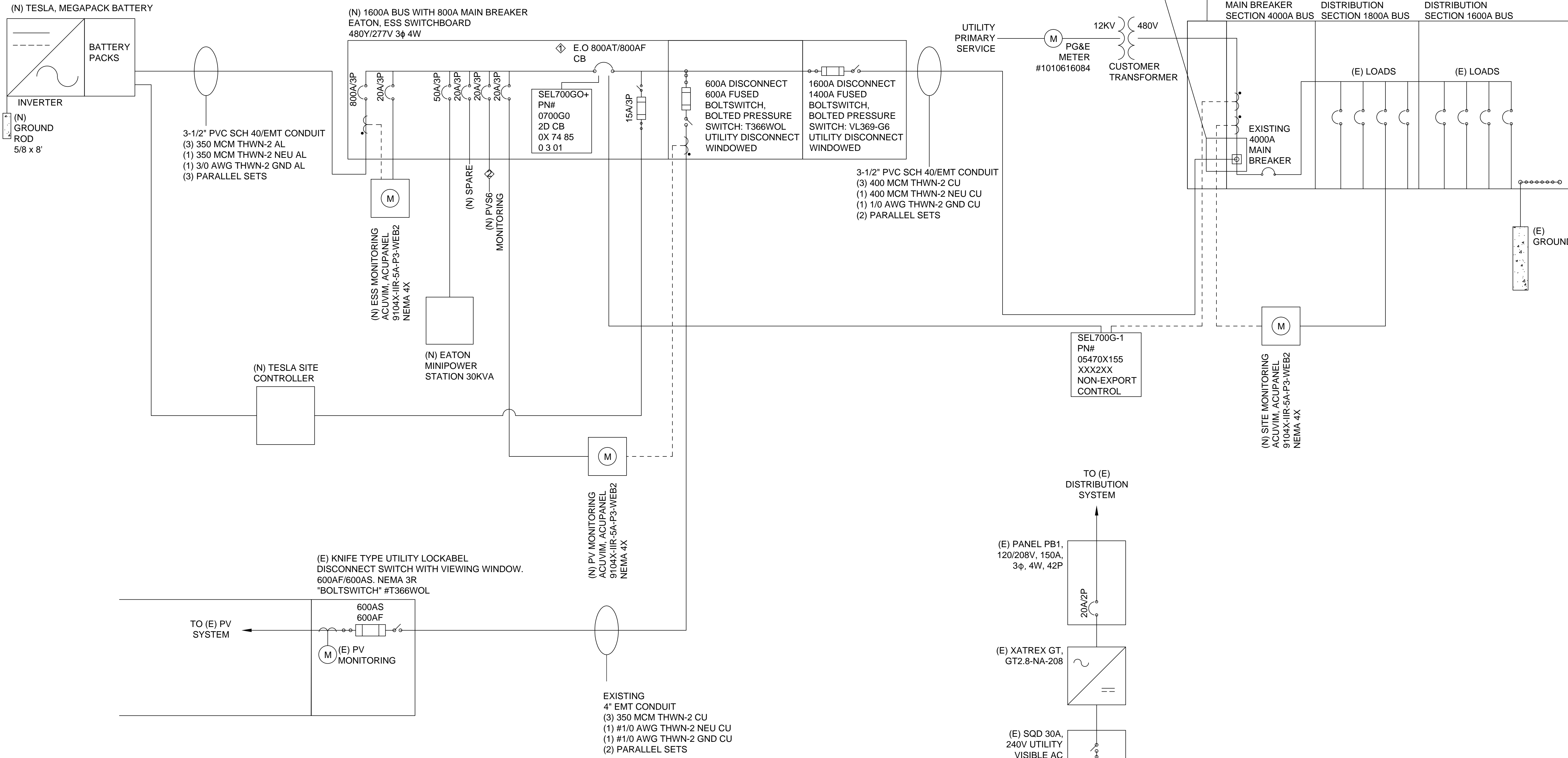

BATTERY ENERGY STORAGE SYSTEM	TESLA MEGAPACK LIGHT
MODEL NUMBER	1462965-XX-Y WELT MR04 PS07 EC09
POWER STAGES	7
INVERTER MAX OUTPUT (KVA)	500.5
BATTERY MODULE OUTPUT (KW)	407.7
SYSTEM ENERGY CAPACITY (KWH)	1630.8
SYSTEM EFFICIENCY (%)	90
QUANTITY OF INVERTERS	1
OUTPUT VOLTAGE	480

EXISTING SOLAR SYSTEM
<b>SOLAR ROOFTOP SYSTEM</b> 408.096KWP 1248 MODULES, SUNPOWER SPR-327 8 MODULES PER STRING, 156 STRINGS
<b>EXISTING INVERTER SYSTEM</b>
(1) SANTERO, TG125 125.568 KWP 384 MODULES, SUNPOWER SPR-327 8 MODULES PER STRING, 48 STRINGS
(2) SANTERO, TG125 141.264 KWP 432 MODULES, SUNPOWER SPR-327 8 MODULES PER STRING, 54 STRINGS
(1) XANTREX GT 1.050KWP 6 MODULES, SOLARWORLD 175MONO 6 MODULES PER STRING, 1 STRING

EXISTING SOLAR INVERTER SUMMARY TABLE					
INVERTER	SPB #	KWP	# OF STRINGS	# OF MODULES	125KW INVERTER
INV-01	SSB02	125.568	48	384	1
INV-02	SSB02	141.264	54	432	1
INV-03	SSB02	141.264	54	432	1
TOTAL		408.096	156	1248	3

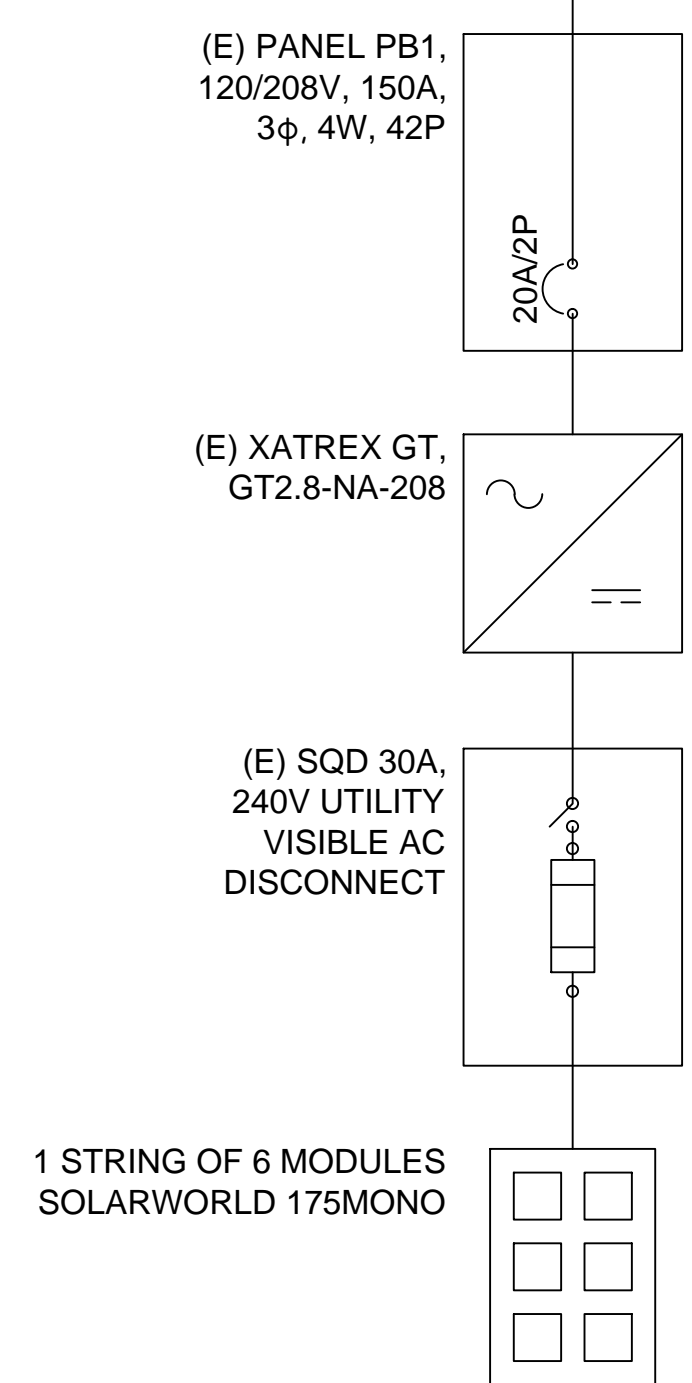

- NOTES:
- NO INSTALLATION OF ANY EQUIPMENT WILL BE INSIDE THE UTILITY'S EQUIPMENT CABINETS OR PULL SECTIONS.
  - CONTROLLER, TESLA SITE CONTROLLER (TSC) IS THE ONLY DEVICE THAT CONTROLS THE CHARGE AND DISCHARGE OF THE BATTERY SYSTEM.
  - UTILITY WILL HAVE 24/7 ACCESS TO ULD
  - INSTALLATION SHALL BE IN ACCORDANCE WITH THE LATEST ADOPTED CALIFORNIA ELECTRICAL CODE AND BUILDING CODE, CHAPTER 15. THE AHJ HAS FINAL JURISDICTION AUTHORITY ON CODE APPLICATION AND COMPLIANCE.
  - ALL EQUIPMENT SHALL BE UL LISTED.
  - MOTOR OPERATED BREAKER WITH CAPACITIVE TRIP.
  - AUX ENCLOSURE FOR STORAGE CONTROL INTERFACE.

**SUNPOWER**  
 1414 HARBOUR WAY SOUTH  
 RICHMOND, CA 94804 USA  
 (510) 540-0560

**CONTRACTOR:**  
**ELITE ELECTRIC Inc.**  
 9415 BELLEGRAVE AVE, RIVERSIDE, CA 92509  
 (951) 681-5811

**STAMP:**  
 ELITE ELECTRIC  
 CARL DAWSON  
 9415 BELLEGRAVE AVE,  
 RIVERSIDE, CA 92509  
 TEL: (951) 681-5811  
 FAX: (951) 681-9543  
 C-10  
 LICENSE #, CA #418242

**SHEET TITLE:**  
 AC SINGLE LINE  
 DIAGRAM

**PROJECT:**  
 OAKLAND USD  
 OAKLAND HS  
 1023 MACARTHUR BLVD.  
 OAKLAND, CA 94610

**PROJECT NO.** 20-177  
**DATE** 05/13/2021  
**SCALE** NTS  
**PERMIT**  
**DRAWN BY** JK

**REVISION NO.**

△ \_\_\_\_\_  
 △ \_\_\_\_\_  
 △ \_\_\_\_\_  
 △ \_\_\_\_\_  
 △ \_\_\_\_\_  
 △ \_\_\_\_\_

**SYSTEM WARRANTY**

1. **System Information.** This Standard Warranty (this “Warranty”) applies to the System installed by Installer pursuant to this Work Authorization.
2. **SunPower System Warranty.** Installer warrants that (a) materials and equipment shall be new and unused as of the date of installation and (b) the System shall conform to the Specification on the Substantial Completion Date and shall be free from defects in materials and workmanship under normal operating conditions for a period of two years thereafter (“Warranty Term”); provided, however, that this Warranty shall not include any warranty statements beyond the scope of this Warranty and provided by Other Manufacturers as described in Section 3 below. Upon a breach of the Warranty during the Warranty Term, Installer will, upon Notice from Customer of a valid warranty claim, at Installer’s sole option, either repair or replace any defective parts. Installer shall have reasonable access to the Site as necessary to perform its warranty obligations under this Agreement. All costs for the removal, replacement and reinstallation of all equipment and materials necessary to gain access to defective Work shall be borne by Installer. Unless this Warranty is extended by written agreement, Customer shall pay for any repair costs incurred by Installer after the Warranty Term expires. This Warranty applies solely to the System and does not include (i) maintenance or (ii) site work, including but not limited to, grading and landscape maintenance, if applicable.
3. **Manufacturer Warranties.** Installer assigns to Customer the applicable pass-through warranties from Installer’s manufacturers, including battery packs and inverters (“Other Manufacturers”). The Other Manufacturers shall be stated in the Design Submittal. Installer warrants that those materials and equipment subject to warranties of Other Manufacturers have been installed in accordance with the requirements of those warranties. Installer makes no representation or warranty, and Customer shall seek no recourse from Installer, unless specifically provided to the contrary, regarding the warranties of Other Manufacturers that extend beyond the scope of this Warranty, including, without limitation, the power output of the battery energy storage system.
4. **Warranty Exceptions.** This Warranty does not apply to:
  - 4.1 Damage, malfunction, or degradation of the System, including electrical output, to the extent caused by:
    - a. failure to Properly Operate or Maintain the System (as described below); or
    - b. any repair or replacement using a part or service not provided or authorized in writing by Installer; or
    - c. normal wear and tear, including expected degradation electrical output; or
    - d. environmental factors, including but not limited to corrosion, insects, animals, lightning, flooding, and winds in excess of design specifications.
  - 4.2 Damage, malfunction, or degradation of the System, including electrical output and System’s supporting structure, to the extent:
    - a. resulting from Customer or third-party abuse, accident, alteration, improper use, solar infringement, negligence, vandalism, theft, or a Force Majeure Event; or
    - b. caused by unknown structural defects with the foundation upon which the System is located, excepting structures installed by Installer and included under this warranty scope; or
    - c. resulting from change in usage of the site, including neighboring surroundings, without the written approval of Installer.
  - 4.3 For purposes of this Section, “Properly Operate and Maintain the System” shall mean that Customer, or qualified party on Customer’s behalf, shall:



- a. perform all initial troubleshooting and diagnostics, including photographic evidence and reporting of inverter fault codes, when applicable, prior to submitting a warranty claim; and
- b. otherwise operate and maintain the System in full accordance with the printed manuals and instructions provided with the System to Customer;

provided that, for the avoidance of doubt, should the operation and maintenance of the System be performed by or on behalf of Installer pursuant to an Operations and Maintenance Agreement providing for such services for the duration of the Warranty Term, Proper Operation and Maintenance shall be deemed satisfied for purposes of this Warranty. Resetting of any protective devices and replacement of any fuses or other consumables within the System are assumed to be included within Proper Operation and Maintenance and not included within the scope of this Warranty.

**5. Successors and Assigns.** This Warranty shall inure to the benefit of and shall be binding upon the Parties and their respective successors and assigns (including, without limitation, any owner or tenant of the Site). No assignment by Customer shall relieve Installer of any of its obligations under this Warranty. Nothing in this Warranty, expressed or implied, is intended to confer any rights, remedies, obligations, or liabilities under or by reason of this Warranty upon any Person other than the Parties.

**6. Disclaimer.** Except as expressly provided herein, Installer expressly disclaims any and all warranties of any kind, express, implied, or statutory, including without limitation any implied warranties of merchantability and/or fitness for a particular purpose. Neither the Agreement nor any document furnished under it, unless explicitly stated, is intended to express, or imply any warranty or guarantee with regard to the performance of the System with respect to (i) electricity output, (ii) reduction in energy costs or environmental savings, (iii) financial savings or return on investment and (iv) public recognition.



Oakland Unified School District

---

**EXHIBIT D**

**SYSTEM COMMISSIONING TESTS**

**[See attached.]**



## MEGAPACK SYSTEM COMMISSIONING PROTOCOL

This document outlines the scope of work required to commission a Tesla **Megapack System**, and identifies the responsible party for each requirement. Tesla defines the commissioning process as the period between the initial submission of the Construction Checklist through the submittal of the signed Commissioning Completion Form.

### Reference Documents

- Megapack Onsite Commissioning Overview

[https://partners.teslamotors.com/en-us/EnergyDocs/Tesla\\_Megapack\\_Onsite\\_Commissioning\\_Overview\\_Checklist.pdf](https://partners.teslamotors.com/en-us/EnergyDocs/Tesla_Megapack_Onsite_Commissioning_Overview_Checklist.pdf)

### Definitions and Cautions

This document defines the key stakeholders using the following names and roles:

<b>Customer</b>	The purchaser of the Megapack System. This is the facility manager, unless a third party operates the energy solution on behalf of the facility manager.
<b>Facility Manager</b>	The owner of the property on which the system is installed.
<b>Construction Manager</b>	The lead in charge of completing the entire Megapack System installation. Also serves as the default point of contact for site access, unless otherwise notified by the customer.
<b>Tesla Project Engineer</b>	The Tesla engineer responsible for reviewing site design and working with the construction manager to complete installation.
<b>Tesla Megapack Support</b>	Tesla Customer Support for Megapack Systems.
<b>Tesla Field Service Technician</b>	Tesla employee or Tesla-approved contractor trained to commission and service Megapack Systems.
<b>Tesla Account Management</b>	Tesla representative responsible for the Commissioning Completion Form.

**NOTE:** This document is written for projects where Tesla is not responsible for construction. For “turnkey” projects where Tesla manages construction, Tesla performs all roles attributed to the Construction Manager in this document and some of the roles attributed to the Customer. The detailed split in responsibilities is defined in the project Scope of Work document that forms part of a turnkey project contract.

**NOTE:** Commissioning requires the Tesla Service team to perform test charging and discharging of the system. **If there are restricted times or conditions when this can occur**, please notify Tesla at [Megapacksupport@tesla.com](mailto:Megapacksupport@tesla.com).

**CAUTION:** Failure to enable and execute charge at the end of 12 months storage may result in permanent system damage and would void the warranty, as described in the Limited Warranty. If units are expected to sit for longer than 12 months between the date of manufacture and installation, the site manager must contact Tesla at [Megapacksupport@tesla.com](mailto:Megapacksupport@tesla.com) to ensure

system readiness. See Tesla's *Megapack Transportation and Storage Guidelines* for additional information.

For allowable storage temperatures before system installation, refer to the *Megapack System Transportation and Storage Guidelines*. For the procedure to put an installed system safely into storage mode, refer to the *Megapack System Operation and Maintenance Manual*.

## Order of Commissioning and Site Events

The order of events for a site is as follows:

### 1. Construction begins.

Responsible Party: Construction Manager

The designated contractor transports all components to the site and physically installs the Megapack System, including positioning, cabinet anchoring, conduit wiring, wiring to all terminals, and site cleanup, per the procedures and standards in the *Megapack System Installation Manual*. The installation team tracks completion on the Tesla-provided Construction Checklist, which the Construction Manager signs and submits in step 3.

### 2. Determine tentative commissioning date.

Responsible Party: Customer

The customer must provide a *tentative* commissioning date to the Tesla Project Engineer. This request is a tentative placeholder for scheduling purposes; however, the actual onsite commissioning date is subject applicability and scheduling change. The Construction Checklist must be successfully completed before an Onsite Commissioning can begin.

### 3. Submit completed Construction Checklist.

Responsible Party: Construction Manager

Upon construction completion, the construction manager must submit the completed Construction Checklist and its associated photos and documents to the Tesla Project Engineer (if one has been assigned). The completion form generated from the Installation Validation App must also be submitted. If you do not receive a response from your Tesla Project engineer within 3 days, please email the documentation to [Megapacksupport@tesla.com](mailto:Megapacksupport@tesla.com).

### 4. Communicate outstanding Construction Checklist items.

Responsible Party: Tesla Project Engineer

Confirms receipt of the Construction Checklist within 3 business days and communicates any outstanding/incomplete items to the Construction Manager to rectify. The



Construction Manager must then rectify any problems and re-submit the Construction Checklist for review. Note that multiple submission-review cycles may be required.

**5. Confirm Construction Checklist is complete.**

Responsible Party: Tesla Project Engineer

Confirms the Construction Checklist as complete once all outstanding items have been rectified as indicted in the last Construction Checklist submission. This step may involve Tesla accessing the system remotely to confirm the installation validation.

**6. Onsite Commissioning (If Applicable)**

Responsible Party: Tesla Onsite Commissioning Personnel

In the event that any issues cannot be rectified, Tesla is able to provide Onsite Commissioning personnel per contractual agreement. See Appendix B below for details regarding Onsite Commissioning.

a) Responsible Party: Tesla Megapack Support

**Schedules the date for Onsite Commissioning to occur.** The onsite commissioning is scheduled for 10 business days after the unsuccessful completion of Remote Commissioning for On-Grid sites, or 20 business days for Grid Interactive or Microgrid sites.

b) Responsible Party: Tesla Field Service technician

**Performs Onsite Commissioning** after rectifying any outstanding issues. Onsite commissioning typically takes one day per Megapack AC transformer block; however, this is highly variable from site to site (Large Utility sites will have individual commissioning plans). See Appendix B below for details of the tasks performed during the onsite commissioning for each Megapack.

**7. Review and send completed Commissioning Completion Form.**

Responsible Party: Tesla Account Management

Reviews the Commissioning Completion Form and sends it to the Customer within 3 business days of commissioning completion.

**8. Sign and return the Commissioning Completion Form.**

Responsible Party: Customer

Countersigns the signed Commissioning Completion Form and returns it to Tesla Account Management to show acceptance of site completion within 3 business days of receiving the completed form in step 9.



Figure 1 below provides an overview and timeline of the steps outlined above.

What	Who	When
1. Begin Construction	Construction Manager	Varies by site
2. Provide desired onsite commissioning date. Placeholder for step 6 only.	Customer	Varies by site
3. Send completed Construction checklist and other deliverables.	Construction Manager	At construction completion
4. Confirm receipt of Construction Checklist. Provide list of items to be rectified.	Project Engineer / Megapack Support	3 business days after Step 3
4 (response). Rectify identified problems, send updated Construction Checklist for review.	Construction Manager	Varies by site
5. Confirm Construction Manager has fully completed Construction Check list with no issues remaining.	Project Engineer / Megapack Support	Varies by site
6a. Schedule Onsite Commissioning (if applicable)	Tesla Field Service Manager	Up to 10 business days after any issue identified in Step 5
6b. Perform Onsite Commissioning (if applicable)	Tesla technician	Varies by site
7. Review and deliver Commissioning Completion Form for sign off	Project Engineer / Megapack Support	Within 3 business days after completion of Step 5, or Step 6 if applicable.
8. Sign and return Commissioning Completion Form to Megapack Support	Customer	Within 3 business days of completion of Step 7

Figure 1: Commissioning and Site Events Overview and Timeline

## Appendix A: Onsite Commissioning (If Applicable)

In the event of unrectified critical issues, Tesla is able to provide onsite personnel per contractual agreement. This is a brief summary of the Onsite Commissioning process. Refer to the *Megapack System Onsite Commissioning Overview* for further details.

The following scope requires approximately 8 hours per Megapack block, and will be run in parallel for each AC transformer block. Only Tesla Service or a Tesla-approved contractor may perform the steps outlined in the procedure below. The exact order and scope of some tests may vary depending on site conditions and configuration.

1. Rectify any outstanding issues identified in the Construction Checklist review and Installation Validation app. This may involve:
  - a) De-energize the system for a full visual inspection of all mechanical and electrical connections.
  - b) Re-energize the system.
  - c) Test communication between all components as listed in the section above.
2. Update system firmware for all inverter blocks to the latest version.
3. Perform basic functional testing, including charge and discharge functions, controller data verification, and thermal system verification.

**NOTE:** If a full power charge could create a peak onsite or trigger export, specify a charge limit when requesting the onsite commissioning visit.

**NOTE:** Tesla may charge all Megapack Units to an 80% State of Charge during commissioning. This can take up to 24-48 hours to complete.

**NOTE:** If the system will be de-energized before regular use begins, the Customer must follow the Storage Mode shutdown procedure in the *Megapack System Operation and Maintenance Manual* to protect battery life.



## Revision Log

<b>Revision #</b>	<b>Date</b>	<b>Description</b>
1.0.0	06-24-2019	<ul style="list-style-type: none"><li>• Initial Release</li></ul>
1.0.1	07-02-2019	<ul style="list-style-type: none"><li>• Changed summary language to clarify scope of document</li></ul>

**EXHIBIT E**

**INDEPENDENT EXPERTS**

- 1) **Sandia National Laboratories**
- 2) **DNV GL** (headquartered in Norway, DNV is a world-leading provider of testing, certification, and advisory services to companies in the electrical power industry, specializing in renewable energy)
- 3) **SGS** (based in Geneva, Switzerland, SGS is an inspection, verification, testing, and certification company)
- 4) **TUV** (based in Newtown, MA, TUV is a testing company that has a specialty solar energy systems practice).

**EXHIBIT F**  
**LOCAL BUSINESS UTILIZATION POLICY**

[See attached.]



## Local Business Utilization (LBU) Policy Sheet

**Policy Established:** December 2008, by the Board of Education for the Oakland Unified School District. On January 29, 2014 the Board adopted and approved the Resolution of the Local, Small Local and Small Local Resident Business Enterprise Program (L/SL/SLRBE) **increasing** the mandatory Local Participation Requirement. (For more information about the LBU Policy, please visit <http://www.ousd.org/cms/lib07/CA01001176/Centricity/Domain/95/2014%20amendment%20to%202008%20LSLRBE%20and%20Facilities%20-%20Board%20Policy%20.pdf>)

**Policy Goal:** To encourage the utilization of local and small local businesses based in Oakland.

**Policy Requirement:** There is a **fifty percent (50%) LBU participation requirement** on all District Capital Program construction contracts and construction related professional service agreements. The 50% Mandatory Requirement can be met with: 25% (or less) Local Business (LBE) participation and 25% (or more) Small Local or Small Local Resident Business (SLBE/SLRBE) participation.

	<b>LBE Maximum Participation</b>	<b>SLBE/SLRBE Minimum Participation</b>
	25%	25%
<b>Total</b>	<b>0% to 25%</b>	<b>25% to 50%</b>

Bids that do not meet 50% LBU requirements are considered non-responsive, unless otherwise approved by the District. All firms meeting 50% LBU participation with a maximum 25% Local Business Enterprise (LBE) and minimum 25% Small Local Business Enterprise (SLBE) or Small Local Resident Business Enterprise (SLRBE) will be considered responsive and receive a **2% bid discount**.

**Additional Bid Discount/Preference Points:** In addition to the 2% bid discount for the minimum 50% participation, firms with participation of 60% - 80% will earn additional bid discounts in the following:

- Bidders receive an additional **1% discount** for **60%** LBU participation, if team has a **minimum 35% SLBE/SLRBE** out of the 60% total participation, will receive 3% bid discount.
- Bidders receive an additional **1% discount** for **70%** LBU participation, if team has a **minimum 45% SLBE/SLRBE** out of the 70% total participation, will receive 4% bid discount.
- Bidders receive an additional **1% discount** for **80% or more** LBU participation. If team has a **minimum 20% SLRBE** and **minimum 35% SLBE** out of the 80% LBU participation the team will receive the **maximum 5% discount**.

<b>LBE Maximum Participation</b>	<b>SLBE/SLRBE Minimum Participation</b>	<b>Total LBE/SLBE/SLRBE Participation</b>	<b>Bid Discount / Preference</b>
25%	35%	60%	3%

<b>LBE Maximum Participation</b>	<b>SLBE/SLRBE Minimum Participation</b>	<b>Total LBE/SLBE/SLRBE Participation</b>	<b>Bid Discount / Preference</b>
25%	45%	70%	4%

<b>LBE Maximum Participation</b>	<b>SLBE Minimum Participation</b>	<b>SLRBE Minimum Participation</b>	<b>Total LBE/SLBE/SLRBE Participation</b>	<b>Bid Discount / Preference</b>
25%	35%	20%	80%	5%



OAKLAND UNIFIED  
SCHOOL DISTRICT

Community Schools, Thriving Students

**Certification:** The District honors local firms certified by the City of Oakland. Firms must be certified prior to bid submittal.

- Proof of certification and resident verification must be submitted no later than 24 hours after bid submittal
- To receive participation credit, all LBU firms MUST be certified upon submittal of bid or proposal.
- For list of firms certified with the City of Oakland go to <http://cces.oaklandnet.com> and click on "LBE/VSLBE/SLBE/LPG Search" or [www.oaklandnet.com](http://www.oaklandnet.com) and click "Business/Contracting with the city" or [www.ousd.org](http://www.ousd.org) and click "District Services/Facilities Planning"

**Bid Responsiveness:** Upon submittal your information will be reviewed and approved for responsiveness and bid discount.

**For more information on the OUSD Local Business Utilization Program, please contact:**

**Shonda Scott**, Local Business Compliance

**shonda@360tcpr.com**

**510.760.9244**

# Local Business Compliance Process

## Pre Bid/Proposal

- Advertise Bid/RFP
- Pre-Bid Walk
- Pre-Bid Outreach
- Pre-Proposal Meeting

## Review Process

- LBU verification forms are included in Bid/RFP documents for responsiveness
- Responsive bids/proposals receive bid discount or preference points

*Note: Teams can only receive a maximum 5% discount/5 preference points*

## Selection Process

- Discount and LBU information is included as part of the team's selection process

## Post Award

- Once the successful team is awarded contract by District, the team's Primes submit monthly LBU Tracking information to the LBU Compliance Team

## Addendum

- *If the LBU verification form is not submitted with Bid/RFP documents, submit as an addendum*

## Non-Responsive

- *Firms not meeting the District's required 50% LBU participation are found non-responsive and rejected*

## Reporting

- *LBU Compliance Team maintains monthly reports of project LBU. Information is reported to the Board of Education*





## LOCAL BUSINESS PARTICIPATION WORKSHEET

PRIME:

Project:

Project #:

Estimate: \$

Date:

Time:

Project Mgr:

Architect:

<b>Based Bid</b>		\$	-
<b>Verified Local Business Participation</b>	<b>0.0%</b>	\$	-
<b>Based Bid W/ LBP Discount</b>		\$	-

	Contract Dollar Amount	LBE	SLBE	SLBRE	COMMENTS:
<b>PRIME:</b>					1
Address:					2
City/State:					3
Phone:( )					4
<b>Company:</b>					1
Address:					2
City/State:Oakland, CA					3
Phone:(510)					4
<b>Company:</b>					1
Address:					2
City/State:Oakland, CA					3
Phone:(510)					4
<b>Company:</b>					1
Address:					2
City/State:Oakland, CA					3
Phone:(510)					4

<b>TOTAL PARTICIPATION</b>	<b>0.00%</b>	<b>0.00%</b>	<b>0.00%</b>	<b>0.00%</b>
----------------------------	--------------	--------------	--------------	--------------

APPROVAL- LBU Compliance Officer

SUNPOWER®

Oakland Unified School District

---

**EXHIBIT G**  
**PROJECT LABOR AGREEMENT**

[See attached.]

Board Office Use: Legislative File Info.	
File ID Number	21-1566
Introduction Date	6/30/21
Enactment Number	21-1038
Enactment Date	6/16/2021 If



# Board Cover Memorandum

**To** Board of Education

**From** Dr. Kyla Johnson-Trammell, Superintendent  
Tadashi Nakadegawa, Deputy Chief of Facilities Planning and Management

**Meeting Date** June 30, 2021

**Subject** Side Letter to Amend the Project Labor Agreement between the District and signatory contractors and subcontractors and the Building and Construction Trades Council of Alameda County, AFL-CIO, and its affiliated Local Union Signatories

**Action Requested** Approval by the Board of Education of the Side Letter to the Project Labor Agreement between the District and signatory contractors and subcontractors and the Building and Construction Trades Council of Alameda County, AFL-CIO, and its affiliated Local Union Signatories for the period from July 1, 2021 to September 28, 2026.

**Background** The District and the Building and Construction Trades Council (the “Council”) originally entered a PLA in February 2004. The original PLA covered construction contracts funded by Measures A and B, except for certain projects under \$400,000. In 2008, the Board approved its Local Business Policy. In April 2010, the District and the Council agreed to a side letter that exempted from the PLA 5% of the total Measure B proceeds in order to assist in the District’s development of more local and emerging contractors.

On September 28, 2016, the District entered into the current PLA which contained all the basic tenets of a PLA - in exchange for a no strike provision and the use of high-speed arbitration to resolve construction disputes, the District agreed that certain construction work funded by District capital funds were subject to the PLA and union work rules. The key provisions of the PLA that remain intact include: (1) Projects covered – All District public work projects; (2) Excluded projects – District may exclude, at its discretion, up to 5% of all capital funds available to the District for its projects during the term of this Agreement. It is expected that the application of this 5% exclusion will not disproportionately affect any one craft. (3) No strikes, sympathy strikes, work stoppages, picketing, hand billing or otherwise advising the public that a labor dispute exists, or slowdowns of any kind; (4) Joint administrative committee to administer PLA; (5) Local hiring – Parties agree to achieve the inclusion of OUSD graduates and Oakland residents in the employment and apprenticeship opportunities created by work under the PLA; (6) Apprentices – Apprentices will perform up to 20% of the total craft hours and only Oakland

residents, especially OUSD graduates will be utilized as apprentices. Both parties will work with community-based organizations such as Cypress Mandela Training Center and the West Oakland Jobs Resource Center to identify potential apprentices. For each covered project, a contractor must hire at least one (1) qualifying apprentice for the first \$1 million of construction bid value (7) Pre-apprenticeship programs – Key components are contained in B9 7116 as amended March 8, 2017 include establishment of a Workforce Development Fund.

**Discussion**

The Side Letter proposes four amendments to the PLA approved by the Board of Education on September 28, 2016:

(1) Extension in the term of the PLA through September 28, 2026.

(2) Replacement of the former written Section 12.2 from “The Contractor/Employer(s) shall require all employees who work on a Construction Contract on or before eight days of consecutive or cumulative employment on the Project to comply with the applicable Union(s)' security provisions, and to maintain compliance for the period of time they are performing work on the Project, which requirement shall be satisfied by the tendering of periodic dues and fees uniformly required to the extent allowed by law. Further, there is nothing in this Agreement that would prevent non-union employees from joining the Union(s).” to “The Contractors/Employers shall make and transmit all deductions for Union dues, fees, and assessments that have been authorized by employees in writing in accordance with the applicable Master Agreement. This Agreement does not require any employee of a non-Union contractor to join a Union or to pay dues or fees to a Union as a condition of working on the Project.”

(3) Increase the contribution of contractors working under the PLA from \$.20 per workhour to \$.30 per workhour performed under the PLA to a Workforce Apprenticeship Development Fund administered by the District with the advice of the Joint Administration Committee of the PLA.

(4) Add a new provision that requires the District and the Council to meet at least once before the close of the 2021 calendar year in order to discuss and agree upon a plan to expand the Construction Careers Program in the District.

On June 11, 2021, Facilities Committee recommended the Side Letter for approval by the Board of Education. Therefore, Staff now request Board approval of the Side Letter to the Project Labor Agreement between the District and signatory contractors and subcontractors and the Building and Construction Trades Council of Alameda County, AFL-CIO, and its affiliated Local Union Signatories for the period from July 1, 2021 to September 28, 2026.

**Fiscal Impact**

N/A

**Attachment(s)**

- Side Letter
- Project Labor Agreement

**OAKLAND UNIFIED SCHOOL DISTRICT PROJECT LABOR AGREEMENT  
AMENDMENT NO. 1**

This Amendment is entered into by and between the Oakland Unified School District (“District”) and the Building and Construction Trades Council of Alameda County (“Council”), as of the execution date of this Amendment.

WHEREAS, the District and the Council, together with the Council’s affiliated and signatory Local Unions (“Unions”), entered into the Project Labor Agreement for the Oakland Unified School District (“Agreement”) on September 28, 2016; and

WHEREAS, the Agreement has promoted the efficiency of construction operations for the District and promoted the public interest in timely and economical completion of public works projects constructed pursuant to the Agreement; and

WHEREAS, Article 22 of the Agreement provides that the Parties may mutually agree in writing to amend, extend, or terminate the Agreement at any time; and

WHEREAS, Section 16.2.3 of the Agreement provides that the District will require that all contractors working under the Agreement contribute \$.20 per work hour performed under the Agreement to a Workforce and Apprenticeship Development Fund administered by the District with advice of the Joint Administration Committee of the Agreement; and

WHEREAS, the Parties now wish to extend the Agreement to cover prospective District construction projects under the Agreement for an additional five years; and

WHEREAS, the Parties now wish to increase the contribution rate under the Agreement to the Workforce and Apprenticeship Development Fund, and to meet before the end of the year to expand the Construction Careers Program in the District; and

WHEREAS, the Parties now wish to replace the language of Section 12.2 to adopt more current language;

NOW THEREFORE, the District and the Council agree to amend the Agreement as follows:

1. The Agreement is extended for an additional five (5) years such that the Agreement has a new expiration date of September 28, 2026.
2. Section 12.2 of the Agreement is hereby replaced, in its entirety, with the following:
  - 12.2 The Contractors/Employers shall make and transmit all deductions for Union dues, fees, and assessments that have been authorized by employees in writing in accordance with the applicable Master Agreement. This Agreement does not require any employee of a non-Union contractor to join a Union or to pay dues or fees to a Union as a condition of working on the Project; however, nothing in this Article is intended to supersede the independent requirements of the applicable Master Agreements as to Contractors/Employers signatory to such

Master Agreements and as to employees of those  
Contractors/Employers who are performing Covered Work.

3. Section 16.2.3 of the Agreement is amended such that the District will require that all contractors working under the Agreement contribute **\$.30** per work-hour performed under the Agreement to a Workforce and Apprenticeship Development Fund administered by the District with the advice of the Joint Administration Committee of the Agreement. The remainder of Section 16.2.3 shall remain as-is.

4. New Section 16.2.5 shall be added to the Agreement, as follows:

16.2.5 The District and the Council shall meet at least once before the close of the 2021 calendar year in order to discuss and agree upon a plan to expand the Construction Careers Program in the District.

**OAKLAND UNIFIED SCHOOL DISTRICT**



\_\_\_\_\_  
Shanthi Gonzales, President, Board of Education

6/17/2021

\_\_\_\_\_  
Date



\_\_\_\_\_  
Kyla Johnson-Trammell, Superintendent

6/17/2021

\_\_\_\_\_  
Date

**BUILDING AND CONSTRUCTION TRADES COUNCIL  
OF ALAMEDA COUNTY, AFL-CIO**

\_\_\_\_\_  
Andreas Cluver, Secretary-Treasurer

\_\_\_\_\_  
Date

Board Office Use: Legislative File Info.	
File ID Number	16-2090
Introduction Date	9/28/16
Enactment Number	16-1528
Enactment Date	9/28/16



OAKLAND UNIFIED  
SCHOOL DISTRICT

Community Schools, Thriving Students

# Memo

**To** Board of Education

**From** Antwan Wilson, Superintendent  
Vernon Hal, Senior Business Officer  
Joe Dominguez, Deputy Chief, Facilities  
Jacqueline Minor, Legal Advisor

**Board Meeting Date** September 28, 2016

**Subject** **Project Labor Agreement between the District and signatory contractors and subcontractors and the Building and Construction Trades Council of Alameda County, AFL-CIO, and its affiliated Local Union Signatories**

**Action Requested** **Approval by the Board of Education of the Project Labor Agreement between the District and signatory contractors and subcontractors and the Building and Construction Trades Council of Alameda County, AFL-CIO, and its affiliated Local Union Signatories for the period from August 24, 2016 to June 30, 2021.**

**Background and Discussion**

The District and the Building and Construction Trades Council (the "Council") originally entered a PLA in February 2004. The original PLA covered construction contracts funded by Measures A and B, except for certain projects under \$400,000. In 2008, the Board approved the Local Business Policy. In April 2010, the District and the Council agreed to a side letter that exempted from the PLA 5% of the total Measure B proceeds in order to assist in the District's development of more local and emerging contractors. In other words, 5% of the funds were exempt in support of the Local Business Policy.

The new PLA continues to contain the basic tenets of all PLAs – in exchange for a no strike provision and the use of high-speed arbitration to resolve construction disputes, the District agrees that certain construction work funded by District capital funds are subject to the PLA and union work rules.

The key provisions of the new PLA are:

1. **Projects: covered.** Those Projects funded by Fund 21-Measure B, Fund 35-County School Facilities Fund, Fund 25-Developer Fees,



- 
- State Prop 39, and OUSD Measure J New Construction and Modernization Projects.
2. **Excluded Projects.** The District may exclude, at its discretion, up to 5% of all capital funds available to the District for its Projects during the term of this Agreement. It is expected that the application of this 5% exclusion will not disproportionately affect any one craft. There are other exclusions, such as work performed by District employees in B&G.
  3. **No strikes,** sympathy strikes, work stoppages, picketing, hand billing or otherwise advising the public that a labor dispute exists, or slowdowns of any kind
  4. Establishment of **Joint Administrative Committee** to administer the PLA.
  5. **Local Hiring.** Parties agree to achieve the inclusion of OUSD graduates and Oakland Residents in the employment and apprenticeship opportunities created by work under the PLA. The goal is that for each construction contract, Residents of the District will perform up to 50 percent (50%) of all hours worked on all covered projects, on a craft-by-craft basis. Non-compliance is subject to review by the Joint Committee and grievance procedures under the PLA.
  6. **Apprentices.** Apprentices will perform up to 20% of the total craft work hours and only Oakland residents, especially District graduates will be utilized as apprentices. Both parties will work with community-based organizations such as, Cypress Mandela Training Center and the West Oakland Jobs Resource Center to identify potential apprentices. For each Covered Project, a Contractor must hire at least one (1) Qualifying Apprentice for the first \$1 million of construction bid value. For each additional \$5 million (beyond the first \$1 million), a Contractor and/or its subcontractors must hire at least one (1) additional Qualifying Apprentice.
  7. **Pre-Apprenticeship Programs.** Key components of the Pre-Apprenticeship program, as approved by the Board in Board Policy 7116, include: a) Establishment and funding a Summer Pre-apprenticeship Internship Program; b) Working in conjunction with the Council, co-sponsor two Building & Construction Trades Career Fairs during each school year; c) Establish a Workforce Development Fund. The Fund shall be audited annually as a part of the annual bond audit. 20% of the Fund may be used by the District for the costs of implementation and management of the Construction and Building Trades Pre-Apprenticeship Programs. No less than 80% of





OAKLAND UNIFIED  
SCHOOL DISTRICT

*Community Schools, Thriving Students*

---

the Fund shall be used to fund direct work based learning programs and apprenticeships for Oakland students; d) Establish an Industry Partnership Council specifically focused on the Building and Construction Trades to support the successful implementation of this program.

**Recommendation**

Approval by the Board of Education of the Project Labor Agreement between the District and signatory contractors and subcontractors and the Building and Construction Trades Council of Alameda County, AFL-CIO, and its affiliated Local Union Signatories

**Fiscal Impact**

Funding resource: N/A

**Attachment**

- Project Labor Agreements



**OAKLAND UNIFIED  
SCHOOL DISTRICT**  
*Community Schools, Thriving Students*

**CONTRACT JUSTIFICATION FORM**  
**This Form Shall Be Submitted to the Board Office**  
**With *Every* Consent Agenda Contract.**

**Legislative File ID No.** 16-2090

**Department:** Superintendent

**Vendor Name:** Building and Construction Trades Council of Alameda County, AFL-CIO and its affiliated Local Union Sign

**Contract Term:** Start Date: 8-24-2016 End Date: 06-30-2021

**Annual Cost:** \$ N/A

**Approved by:** Superintendent

**Is Vendor a local Oakland business?** Yes  No

**Why was this Vendor selected?**

This vendor was selected to promote local hiring of OUSD graduates and Oakland residents in the employment apprenticeship opportunities created by work under the PLA.

**Summarize the services this Vendor will be providing.**

The vendor will direct work based learning programs and apprenticeships for Oakland students.

**Was this contract competitively bid?** Yes  No

If No, answer the following:

1) How did you determine the price is competitive?

2) Please check the competitive bid exception relied upon:

- Educational Materials**
- Special Services** contracts for financial, economic, accounting, legal or administrative services
- CUPCCAA exception** (Uniform Public Construction Cost Accounting Act)
- Professional Service Agreements** of less than \$87,800 (increases a small amount on January 1 of each year)
- Construction related Professional Services** such as Architects, DSA Inspectors, Environmental Consultants and Construction Managers (require a "fair, competitive selection process)
- Energy** conservation and alternative energy supply (e.g., solar, energy conservation, co-generation and alternate energy supply sources)
- Emergency** contracts [requires Board resolution declaring an emergency]
- Technology** contracts
  - electronic data-processing systems, supporting software and/or services (including copiers/printers) over the \$87,800 bid limit, must be competitively advertised, but any one of the three lowest responsible bidders may be selected
  - contracts for computers, software, telecommunications equipment, microwave equipment, and other related electronic equipment and apparatus, including E-Rate solicitations, may be procured through an RFP process instead of a competitive, lowest price bid process
  - Western States Contracting Alliance Contracts (WSCA)
  - California Multiple Award Schedule Contracts (CMAS) [contracts are often used for the purchase of information technology and software]
- "Piggyback" Contracts** with other governmental entities
- Perishable Food**
- Sole Source**
- Change Order for Material and Supplies** if the cost agreed upon in writing does not exceed ten percent of the original contract price
- Other, please provide specific exception**

**PROJECT LABOR AGREEMENT  
FOR THE  
OAKLAND UNIFIED SCHOOL DISTRICT**

**And**

**Building and Construction Trades Council of Alameda County, AFL-CIO ("Council")  
And Affiliated Local Union Signatories**

---

**PREAMBLE**

This Agreement is made and entered into by and between the Oakland Unified School District ("OUSD" or "District") together with contractors and subcontractors who shall become signatory to this Agreement by signing the "Agreement To Be Bound" (Addendum "A"), ("Contractor/Employer(s)"), and the Building and Construction Trades Council of Alameda County, AFL-CIO ("Council") and its affiliated Local Unions signatory hereto ("Union(s)").

The purpose of this Agreement is to promote efficiency of construction operations for capital projects funded by OUSD, including but not limited to Fund 21-Measure B, Fund 35-County School Facilities Fund, Fund 25-Developer Fees, State Prop 39, and OUSD Measure J New Construction and Modernization Projects, by providing for the orderly and peaceful settlement of labor disputes and grievances without strikes, work stoppages or lockouts, thereby promoting the public interest in assuring the timely and economical completion of the Project.

The relevant skilled work force requirements described in Education Code section 17407.5 as that statute relates to the commitment that a skilled and trained workforce will be used to perform the Project(s), is deemed to have been established by any Contractor becoming a signatory to this Agreement.

**RECITALS**

WHEREAS, the timely and successful completion of the Project is of the utmost importance to the District; and

WHEREAS, large numbers of workers of various skills will be required in the performance of the construction work, including those to be represented by the Union(s) signatory to this Agreement employed by Contractor/Employer(s) who are also signatories to this Agreement; and

WHEREAS, it is recognized that on a project of this magnitude with multiple contractors and bargaining units on the job site at the same time over an extended period of time, the potential for work disruption is substantial without an overriding commitment to maintain continuity of work; and

WHEREAS, the interests of the general public, District, the Union(s) and Contractor/Employer(s) would be best served if the construction work proceeded in an orderly manner without disruption because of strikes, sympathy strikes, work stoppages, picketing, lockouts, slowdowns or other interferences with work; and

WHEREAS, the Contractor/Employer(s) and the Union(s) desire to mutually establish and stabilize wages, hours and working conditions for the workers employed on the Project by the Contractor/Employer(s), and further, to encourage close cooperation among the Contractor/Employer(s) and the Union(s) so that a satisfactory, continuous and harmonious relationship will exist among the parties to this Agreement; and

WHEREAS, the parties agree that one of the primary purposes of this Agreement is to avoid the tensions that might arise on the Project if union and non-union workers of different employers were to work side by side on the Project thereby leading to labor disputes that could delay completion of the Project; and

WHEREAS, this Agreement is not intended to replace, interfere with, abrogate, diminish or modify existing local or national collective bargaining agreements in effect during the duration of the Project, insofar as a legally binding agreement exists between the Contractor/Employer(s) and the affected Union(s), except to the extent that the provisions of this Agreement are inconsistent with said collective bargaining agreements, in which event, the provisions of this Agreement shall prevail; and

WHEREAS, the contract(s) for construction work on the Project will be awarded in accordance with the applicable provisions of the California Public Contract Code and the District's Local Business Utilization policy; and

WHEREAS, the District desires to provide construction training and employment opportunities for OUSD graduates and residents of Oakland through apprentice and pre-apprentice programs; and

WHEREAS, the parties to this Agreement pledge their full good faith and trust to work towards a mutually satisfactory completion of the Project;

NOW, THEREFORE, IT IS AGREED BETWEEN AND AMONG THE PARTIES HERETO, AS FOLLOWS:

## **ARTICLE 1**

### **DEFINITIONS**

- 1.1 "District" means the Oakland Unified School District.
- 1.2 "Agreement" means this Project Labor Agreement and all Addenda attached hereto.
- 1.3 "Agreement To Be Bound" means the document, as set forth in Addendum A hereto, that formally binds the Contractor/Employer(s) to comply with all the terms and conditions of this Agreement and that operates as a pre-condition to performing work on the Project.

- 1.4 "Apprentice" means an individual registered and participating as an apprentice in a Joint Labor/Management Apprenticeship Program approved by the State of California, Department of Industrial Relations, Division of Apprenticeship Standards.
- 1.5 "Completion" of work on a project means that point at which the District has determined that the work to construct the project is in all respects 100% complete and that all contract drawings, warranties, certificates, manuals and data have been submitted and training completed in accordance with the contract documents. Division of State Architect approval is not required for a determining that a project is complete.
- 1.6 "Construction Contract" means the public works or improvement contract(s), including design-bid-build, design-build, lease-leaseback or other contracts under which construction of the Project is done, which will be awarded by the District and which are necessary to complete the Project, including subcontracts at any tier.
- 1.6 "Contractor/Employer(s)" means any individual, firm, partnership or corporation, or combination thereof, including joint ventures, and their successors and assigns, that is an independent business enterprise and enters into a contract with the District or any of its contractors or subcontractors at any tier, with respect to the construction of any part of the Project under contract terms and conditions approved by the District and which incorporate this Agreement.
- 1.7 "Coordinator" means a designated Agent(s) of the district with authority to act pursuant to this Agreement.
- 1.7 "Council" means the Building and Construction Trades Council of Alameda County, AFL-CIO.
- 1.8 "Master Labor Agreement" ("MLA") means the Master Collective Bargaining Agreement of each craft Union(s) signatory to this Agreement, incorporated herein by reference, of which a copy of the most current version, including any amendments shall be made available the District upon request.
- 1.9 "Project" means a work of improvement for the construction of projects described in section 2.3.
- 1.10 "Sole Operator" means a licensed contractor with no employees and exempted by the Contractor's State License Board from the requirement to carry workers' compensation insurance. (*See: California Business and Professions Code section 7125.*)
- 1.11 "Trust Fund(s)" means an agreement for an established vacation, pension or other form of deferred compensation plan, apprenticeship, health benefit, and worker protection and assistance funds established by an applicable Master Labor Agreement.
- 1.12 "Union(s)" means the Building and Construction Trades Council of Alameda County, AFL-CIO and any affiliated Labor Organization signatory to this Agreement, acting on their own behalf and on behalf of their respective affiliates and member

organizations, whose names are subscribed hereto and who have through their officers executed this Agreement.

1.13 "Oakland Resident" means any individual who at any time during the Projects' construction can certify through a utility bill, or other similar means acceptable to the parties to this Agreement, that the individual resided within the boundaries of the Oakland Unified School District on the date of such certification and the effective date of this Agreement.

1.14 "District Graduate" is a person who attended school in Oakland, has a high school diploma or equivalent credential, and currently resides within the boundaries of the Oakland Unified School District.

## **ARTICLE 2**

### **SCOPE OF AGREEMENT**

2.1 Scope: The District will apply this Agreement as a contract specification to the award of all construction contracts as specifically defined herein under this Article 2 of this Agreement.

2.2 Parties: The Agreement shall apply and is limited to all Contractor/Employer(s) performing or subcontracting work on the Project (including subcontractors at any tier), the District, the Council and the Union(s) signatory to this Agreement, acting on their own behalf and on behalf of their respective affiliates and member organizations, whose names are subscribed hereto and who have through their officers executed this Agreement.

2.3 Project Description: All District public work construction projects ("Project(s)") contracted by the District funds. The District may exclude, at its discretion, up to 5% of all capital funds available to the District for its Projects during the term of this Agreement. It is expected that the application of this 5% exclusion will not disproportionately affect any one craft. This exclusion will be reviewed by the Parties on an annual basis as requested by either Party or during an agenzized JAC meeting.

2.4 Covered Work: This Agreement covers, all site preparation, surveying, construction, alteration, demolition, installation, painting, improvement or repair of buildings, structures and other works, and related activities for the Project, including geotechnical and exploratory drilling conducted after bid, temporary HVAC, landscaping and temporary fencing, installation of modular office systems when associated with a covered project, and that is within the craft jurisdiction of one of the Union(s) and which is directly or indirectly part of the Project, including, without limitation to the following examples, pipelines (including those in linear corridors built to serve the project), pumps, pump stations and start-up., .On-site work includes work done for the Project in temporary yards, dedicated sites, or areas adjacent to the Project, and at any on-site or off-site batch plant constructed solely to supply materials to the Project. This scope of work includes all on-site soils and

materials testing and inspection, where such testing and inspection is a classification in which a prevailing wage determination has been published.

- 2.4.1 This Agreement shall apply to any start-up, calibration, commissioning, performance testing, repair, operational revisions to systems and/or subsystems performed on covered work after Project Completion, unless the covered work it is performed by District employees.
- 2.4.2 This Agreement covers all on-site fabrication work over which the District, or its contractor(s) or subcontractor(s) possess the right of control (including work done for the Project in any temporary yard or area established for the Project.). Additionally, it is agreed hereby that this Agreement covers any off-site work, including fabrication work necessary for the Project defined herein, that is covered by a current MLA or local addenda to a National Agreement of the applicable Union(s) that is in effect as of the execution date of this Agreement.
- 2.4.3 The furnishing of supplies, equipment or materials which are stockpiled for later use shall not be covered by this Agreement. However, construction trucking work, such as the delivery of ready-mix, asphalt, aggregate, sand or other fill material which are incorporated into the construction process as well as the off-hauling of debris and excess fill, material and/or mud, shall be covered by the terms and conditions of this Agreement.
- 2.4.5 It is agreed that the District shall require all Contractors of whatever tier who have been awarded contracts for work covered by this Agreement, to accept and be bound by the terms and conditions of this Project Agreement by executing the **Letter of Assent (Attachment A)** prior to commencing work. The District shall assure compliance with this Agreement by the Contractors. It is further agreed that, where there is a conflict, the terms and conditions of this Project Agreement shall supersede and override terms and conditions of any and all other national, area, or local collective bargaining agreements, except that work covered by this Agreement within the following craft jurisdictions shall be performed under the terms of their National Agreements as follows: the NTL Articles of Agreement, the National Stack/Chimney Agreement, the National Cooling Tower Agreement, and the National Agreement of Elevator Constructors, and any instrument calibration work and loop checking shall be performed under the terms of the UA/IBEW Joint National Agreement for Instrument and Control Technicians, with the exception that Articles V, VI and XI of this Agreement shall apply to such work. It is understood that this, together with the MLAs, is a self-contained, stand alone, Agreement and that by virtue of having become bound to this Project Agreement, neither the District nor the Contractors will be obligated to sign any other local, area, or national agreement.
- 2.5 The on-site installation or application of all items shall be performed by the craft having jurisdiction over such work as set forth under the provisions of this Agreement; provided, however, it is recognized that installation of specialty items which may be furnished by the owner of the Project or a contractor shall be performed by construction persons employed under this Agreement who may be directed by other personnel in a supervisory role.



- 2.6 After installation by the Contractor(s) and upon the issuance of a notice of final completion or formal acceptance of a portion of the project or a building system by the District, it is understood, the District reserves the right to perform start-up, operation, repair, maintenance or revision of equipment or systems with employees of the District. If required, the service representative may make a final check and may direct on site craftworkers, covered by this agreement, to make any necessary repairs to protect the terms of a manufacturer's guarantee or warranty prior to start-up of a piece of equipment.
- 2.7 It is expressly agreed and understood by the parties hereto that the District shall have the right to purchase material and equipment from any source, except where limited by this Agreement, and the craftspersons will handle and install such material and equipment.
- 2.8 Exclusions. The following shall be excluded from the scope of this Agreement:
- 2.8.1 The Agreement is not intended to, and shall not affect or govern the award of public works contracts by the District which are not included in the Project.
- 2.8.2 The Agreement shall not apply to a Contractor/Employer(s)' non-construction craft employees, including but not limited to executives, managerial employees, engineering employees and supervisors above the level of General Foreman (except those covered by existing MLAs), staff engineers or other professional engineers, administrative and management. This Agreement shall not apply to Professional Services so long as the work performed is not subject to Prevailing Wage classifications.
- 2.8.3 This Agreement shall not apply to any work performed on or near or leading to the site of work covered by this Agreement that is undertaken by state, county, city or other governmental bodies or their contractors; or by public or private utilities or their contractors.
- 2.8.4 Off-site maintenance of leased equipment and on-site supervision of such work;
- 2.8.5 The District shall not be required to comply with this Agreement for any work performed with its own forces as permitted by the Public Contract Code and Education Code.
- 2.9 Award of Contracts: It is understood and agreed that the District shall have the absolute right to select any qualified bidder for the award of contracts under this Agreement, and in accord with the District's Local Business Policy. The bidder need only be willing, ready and able to execute and comply with this Agreement.

### ARTICLE 3

#### EFFECT OF AGREEMENT

- 3.1 By executing the Agreement, the Union(s) and District agree to be bound by each and all of the provisions of the Agreement.
- 3.2 By accepting the award of a construction contract for the Project, whether as contractor or subcontractor, the Contractor/Employer(s) agrees to be bound by each and every provision of the Agreement and agrees that it will evidence its acceptance prior to the commencement of work by executing the **Agreement To Be Bound** in the form attached hereto as **Addendum A**.
- 3.3 At the time that any Contractor/Employer(s) enters into a subcontract with any subcontractor providing for the performance of a construction contract, the Contractor/Employer(s) shall provide a copy of this Agreement to said subcontractor and shall require the subcontractor as a part of accepting an award of a construction subcontract to agree in writing to be bound by each and every provision of this Agreement prior to the commencement of work. The obligations of a Contractor/Employer(s) may not be evaded by subcontracting.
- 3.4 Each Contractor/Employer(s) shall give written notice to the Union(s) of any subcontract involving the performance of work covered by this Agreement within either seven (7) days of entering such subcontract or before such Contractor/Employer(s) commences work on the Project, whichever occurs first. Such notice shall specify the name, address, phone number, and the California State License Board license number of the Contractor/Employer(s). Written notice at a Pre-Job Conference shall be deemed written notice under this provision for those Contractor/Employer(s) listed and present at the Pre-Job only.
- 3.5 The provisions of this Agreement, including MLA's, shall apply to the work covered by this Agreement, notwithstanding the provisions of any other local, area and/or national agreements which may conflict with or differ from the terms of this Agreement. Where a subject covered by the provisions of this Agreement is also covered by a MLA, the provisions of this Agreement shall prevail. Where a subject is covered by the provisions of a MLA and is not covered by this Agreement, the provisions of the MLA shall prevail.
- 3.6 (a) With regard to any Contractor/Employer(s) that is independently signed to any MLA, this Project Labor Agreement shall in no way supersede or prevent the enforcement of any subcontracting clause contained in such MLA, except as specifically set forth in subsection (b) of this Section 3.6. Any such subcontracting clause in an MLA shall remain and be fully enforceable between each craft union and its signatory employers, and no provision of this Project Labor Agreement shall be interpreted and/or applied in any manner that would give this Project Labor Agreement precedence over subcontracting obligations and restrictions that exist between craft unions and their respective signatory employers under an MLA, except as specifically set forth in subsection (b) of this Section 3.6.

- (b) If a craft union (hereafter "Aggrieved Union") believes that an assignment of work on this Project has been made improperly by a contractor or subcontractor, even if that assignment was as a result of another craft union's successful enforcement of the subcontracting clause in its MLA, as permitted by subsection (a) of this Section 3.6, the Aggrieved Union may submit a claim under the jurisdictional resolution process contained in Article 6 of this PLA, and the decision rendered as part of that process shall be enforceable to require the contractor or subcontractor that made the work assignment to assign that work prospectively to the Aggrieved Union. An award made to a craft union under the subcontracting clause of its MLA, as permitted pursuant to Section 3.6 (a) of this Article, shall be valid and fully enforceable by that craft union unless it conflicts with a jurisdictional award made pursuant to this Agreement. If the award made under the MLA conflicts with the jurisdictional award, the award of any damages under the former shall be null and void ab initio.

#### **ARTICLE 4**

##### **RELATIONSHIP BETWEEN PARTIES**

- 4.1 This Agreement shall only be binding on the signatory parties hereto, their successors and assigns, and shall not apply to parents, affiliates, subsidiaries, or other ventures of any such party.
- 4.2 Each Contractor/Employer(s) shall alone be liable and responsible for its own individual acts and conduct and for any breach or alleged breach of this Agreement. Any alleged breach of this Agreement by a Contractor/Employer(s) or any dispute between the Union(s) and the Contractor/Employer(s) respecting compliance with the terms of this Agreement, shall not affect the rights, liabilities, obligations and duties between the signatory Union(s) and each other Contractor/Employer(s), party to this Agreement.
- 4.3 It is mutually agreed by the parties that any liability of a Union(s) shall be several and not joint. Any alleged breach of this Agreement by a signatory Union(s) shall not affect the rights, liabilities, obligations and duties between the Contractor/Employer(s) and the other Union(s) party to this Agreement.
- 4.4 It is recognized by the parties to this Agreement that the Contractor/Employer(s) are acting only on behalf of said Contractor/Employer(s), and said Contractor/Employer(s) have no authority, either expressed, implied, actual, apparent or ostensible, to speak for or bind the District.

#### **ARTICLE 5**

##### **NO STRIKES - NO LOCKOUTS**

- 5.1 The Union(s), District and Contractor/Employer(s) covered by the Agreement agree that for the duration of the Project:
- 5.1.1 There shall be no strikes, sympathy strikes, work stoppages, picketing, hand billing or otherwise advising the public that a labor dispute exists, or

slowdowns of any kind, for any reason, by the Union(s) or employees employed on the Project, at the job site of the Project because of a dispute on the Project or on any other District construction projects otherwise exempted or excepted under Article 2 from this Agreement.

5.1.2 As to employees employed on the Project, there shall be no lockout of any kind by a Contractor/Employer(s) covered by the Agreement.

5.1.3 If a master collective bargaining agreement expires before the Contractor/Employer(s) completes the performance of the Construction Contract and the Union(s) or Contractor/Employer(s) gives notice of demands for a new or modified master collective bargaining agreement, the Union(s) agrees that it will not strike on work covered under this Agreement and the Union(s) and the Contractor/Employer(s) agree that the expired master collective bargaining agreement shall continue in full force and effect for work covered under this Agreement until a new or modified master collective bargaining agreement is reached. If the new or modified master collective bargaining agreement provides that any terms of the master collective bargaining agreement shall be retroactive, the Contractor/Employer(s) agrees to comply with any retroactive terms of the new or modified master collective bargaining agreement which are applicable to employees who were employed on the projects during the interim, with retroactive payment due within seven (7) days of the effective date of the modified Master Agreement.

5.1.4 Withholding employees for failure of a Contractor/Employer(s) to tender timely Trust Fund(s) contributions as required in accordance with Article 16 and/or for failure to timely meet its weekly payroll is not a violation of this Article 5; however, the Union(s) shall give the affected Contractor/Employer(s) and the District written notice seventy two (72) hours prior to the withholding of employees when repeated failure to tender Trust Fund(s) contributions has occurred. There shall be forty-eight (48) hours' notice when repeated failure to meet weekly payroll has occurred, or when paychecks are determined to be nonnegotiable by a financial institution normally recognized to honor such paychecks. For purposes of this section, repeated failure means failure to meet payroll obligations on at least 2 separate occasions. Union(s) shall stop withholding employees within 24 hours of Contractor/Employer curing its contribution or paycheck violations.

Should a Contractor/Employer(s) performing work on this Project be delinquent in the payment of Trust Fund(s) contributions required under this Agreement, the Union(s) may request that the general Contractor/Employer(s) issue joint checks payable to the Contractor/Employer(s) and the appropriate employee benefit Trust Fund(s), on behalf of the employee(s) until such delinquencies are satisfied. Any Trust Fund(s) claiming that a Contractor/Employer(s) is delinquent in its fringe benefit contributions to the Trust Fund(s) will provide written notice of the alleged delinquency to the affected Contractor/Employer(s), with copies to the General Contractor/Employer(s) and the District. The notice will indicate the amount of delinquency asserted and the period that the delinquency covers. It is agreed, however, with respect to Contractor/Employer(s) delinquent in

trust or benefit contribution payments, that nothing in this Agreement shall affect remedies available under the MLAs. If the General Contractor/Employer(s) is delinquent in the payment of Trust Fund(s) contributions for covered work performed on this project, the General Contractor/Employer(s) agrees that the affected Trust Fund(s) may place the District on notice of such delinquencies and the General Contractor/Employer(s) further agrees that the District may withhold payment, in whole or in part, until the delinquency is satisfied. If the delinquency remains unsatisfied for more than 30-days, District shall be authorized to issue joint checks to the General Contractor/Employer(s) and the Trust Fund(s), on behalf of the affected employee(s). This withhold and/or joint check issuance shall be the only remedy available to either the Union(s) or Trust Fund(s) under this Agreement. The aggrieved Union(s) or Trust Fund(s) herein agree not file a stop payment notice pursuant to Civil Code section 8100 et seq., unless the District fails to withhold payment or issue joint checks as specified herein, provided, however, that the District shall have 30 additional days from the delinquency withhold to process the joint check warrants.

5.1.5 If the District contends that any Union has violated this Article, it will notify in writing (including email) the Secretary-Treasurer/Business Manager/Senior Executive of the Council and the Senior Executive of the Union, setting forth the facts alleged to violate the Article, prior to instituting the expedited arbitration procedure set forth below. The Council will immediately use his/her best efforts to cause the cessation of any violation of this Article, including the release of any improperly filed stop payment notice. The leadership of the Union will immediately notify the membership of its obligations under this Article.

5.2 Expedited Arbitration: Any party to this Agreement shall institute the following procedure, prior to initiating any other action at law or equity, when a breach of this Article is alleged to have occurred:

5.2.1 A party invoking this procedure shall notify Bob Hirsch, as the permanent Arbitrator, or, Barry Winograd, as the alternate Arbitrator under this procedure. In the event that the permanent Arbitrator is unavailable at any time, the alternate will be contacted. If neither is available, then a selection shall be made from the list of Arbitrators in Article 11.2.2, Step 5. Notice to the Arbitrator shall be by the most expeditious means available, with notices by facsimile, email or telephone to the District and the party alleged to be in violation, and to the Council and involved local Union(s) if a Union(s) is alleged to be in violation.

5.2.2 Upon receipt of said notice, the District will contact the designated Arbitrator named above or his alternate who will attempt to convene a hearing within twenty-four (24) hours if it is contended that the violation still exists.

- 5.2.3 The Arbitrator shall notify the parties by facsimile, email or telephone of the place and time for the hearing. Said hearing shall be completed in one session, which, with appropriate recesses at the Arbitrator's discretion, shall not exceed twenty-four (24) hours unless otherwise agreed upon by all parties. A failure of any party to attend said hearings shall not delay the hearing of evidence or the issuance of an award by the Arbitrator.
- 5.2.4 The sole issue at the hearing shall be whether or not a violation of Article 5, Section 5.1 of the Agreement has occurred. The Arbitrator shall have no authority to consider any matter of justification, explanation or mitigation of such violation or to award damages, which issue is reserved for court proceedings, if any. The award shall be issued in writing within three (3) hours after the close of the hearing, and may be issued without a written opinion. If any party desires a written opinion, one shall be issued within fifteen (15) days, but its issuance shall not delay compliance with or enforcement of the award. The Arbitrator may order cessation of the violation of this Article and other appropriate relief and such award shall be served on all parties by hand or certified mail upon issuance. Should a party found in violation of this Article fail to comply with an Arbitrator's award to cease the violation, the party in violation shall pay to the affected party as liquidated damages the sum of ten thousand dollars (\$10,000.00) per shift for which it failed to comply, or portion thereof, until such violation is ceased. The Arbitrator shall retain jurisdiction to resolve any disputes regarding the liquidated damages claimed under this section.
- 5.2.5 Such award may be enforced by any Court of competent jurisdiction upon the filing of this Agreement and all other relevant documents referred to above in the following manner. Written notice of the filing of such enforcement proceedings shall be given to the other party. In the proceeding to obtain a temporary order enforcing the Arbitrator's award as issued under Section 5.2.4 of this Article, all parties waive the right to a hearing and agree that such proceedings may be ex parte. Such agreement does not waive any party's right to participate in a hearing for a final order or enforcement. The Court's order or orders enforcing the Arbitrator's award shall be served on all parties by hand or delivered by certified mail.
- 5.2.6 Any rights created by statute or law governing arbitration proceedings inconsistent with the above procedure, or which interfere with compliance, are waived by the parties.
- 5.2.7 The fees and expenses of the Arbitrator shall be divided equally between the party instituting the arbitration proceedings provided in this Article and the party alleged to be in breach of its obligation under this Article.

## **ARTICLE 6**

### **WORK ASSIGNMENTS AND JURISDICTIONAL DISPUTES**

- 6.1 The assignment of Covered Work will be solely the responsibility of the Contractor/Employer(s) performing the work involved; and such work assignments

will be in accordance with the Plan for the Settlement of Jurisdictional Disputes in the Construction Industry (the "Plan") or any successor Plan.

- 6.2 All jurisdictional disputes on this Project between or among the Union(s) and the Contractor/Employer(s), parties to this Agreement, shall be settled and adjusted according to the present Plan established by the Building and Construction Trades Department, or any other plan or method of procedure that may be adopted in the future by the Building and Construction Trades Department. Decisions rendered shall be final, binding and conclusive on the Contractor/Employer(s) and Union(s) parties to this Agreement.
- 6.2.1 If a dispute arising under this Article involves the Northern California Carpenters Regional Council or any of its subordinate bodies, an Arbitrator shall be chosen by the procedures specified in Article V, Section 5, of the Plan from a list composed of John Kagel, Thomas Angelo, Robert Hirsch, and Thomas Pagan, and the Arbitrator's hearing on the dispute shall be held at the offices of the California State Building and Construction Trades Council in Sacramento, California, within 14 days of the selection of the Arbitrator. All other procedures shall be as specified in the Plan.
- 6.3 All jurisdictional disputes shall be resolved without the occurrence of any strike, work stoppage, or slow-down of any nature, and the Contractor/Employer(s)' assignment shall be adhered to until the dispute is resolved. Individuals violating this Section shall be subject to immediate discharge.
- 6.4 Each Contractor/Employer(s) shall conduct a Pre-Job Conference with the Council prior to commencing Covered Work. The Primary Employer and the District will be advised in advance of all such conferences and may participate if they wish. Pre-job conferences for different Contractor/Employer(s) may be held together.

## **ARTICLE 7**

### **PRE-JOB CONFERENCES**

- 7.1 Prior to the commencement of any Project Work, the Prime Employer shall notify the Council of the need to convene a preconstruction conference. Such conference shall be held in a timely manner a minimum of seven (7) days prior to the commencement of each and every construction phase or construction contract for the Project. The preconstruction conference shall be conducted by the Council and held at a location selected by the Council. Such preconstruction conference shall be attended by a representative each from the participating Contractor(s) and Union(s) and the Prime Employer.
- 7.2 All Contractor(s) at all tiers that are required to participate in the preconstruction conference shall be prepared to make Craft assignments of work and to discuss in detail all issues that may impact or are relevant to the particular construction work being performed and shall include, but not be limited to, the information as set forth below.

- (a) A listing of each Contractor(s)'s scope of work, including the estimated start and completion dates;
- (b) A listing of all sub-contractors performing work under the direction of each Contractor(s) participating in the preconstruction conference;
- (c) The estimated number of craft workers required to perform the work;
- (d) A copy of the signed Letter of Assent for each Contractor(s);
- (e) A listing of all Sole Operators performing work on the Project and subject to Article 13.2 of this Agreement.

7.3 Review Meetings - In order to ensure the terms of this Agreement are being fulfilled and all concerns pertaining to the Prime Contractor(s), the Union(s), and the Contractor(s) are addressed, the Prime Contractor(s), General Contractor(s) and Secretary-Treasurer of the Council or designated representatives thereof shall meet on a periodic basis during the term of construction.

## **ARTICLE 8**

### **MANAGEMENT RIGHTS**

8.1 Consistent with the MLAs, the Contractor/Employer(s) shall retain full and exclusive authority for the management of their operations, including the right to direct their work force in their sole discretion. No rules, customs or practices shall be permitted or observed which limit or restrict production, or limit or restrict the working efforts of employees except that lawful manning provisions in the MLA shall be recognized.

## **ARTICLE 9**

### **WORK RULES**

9.1 Work rules shall apply as set forth in the applicable MLA.

## **ARTICLE 10**

### **JOINT ADMINISTRATIVE COMMITTEE**

10.1 The parties to this Agreement shall establish a four (4) person Joint Administrative Committee. This Committee shall be comprised of two (2) representatives selected by the District and two (2) representatives selected by the Council. The District and the Council shall designate alternates who shall serve in the absence of designated representatives for any purpose contemplated by this Agreement. The Joint Administrative Committee shall meet quarterly, or at the request of either Party to this Agreement to review the implementation of the Agreement and the progress of the Projects. It shall be the responsibility of the Coordinator to convene and facilitate the quarterly meetings and any other meetings requested by the Parties.

10.2 The Joint Administrative Committee shall appoint a Joint Administrative Subcommittee consisting of one District representative and one Union(s) representative for the purpose of convening to confer in an attempt to resolve a



grievance that has been filed consistent with Article 11. Any question regarding the meaning, interpretation, or application of the provisions of this Agreement shall be referred directly to the Joint Administrative Subcommittee for resolution. The Joint Administrative Subcommittee shall meet as required to resolve grievances by majority vote with such resolutions to be final and binding on all signatories of the Agreement. A failure of any party or parties to attend said hearing shall not delay the hearing of evidence or issuance of an award by the Joint Administrative Subcommittee, if such award is made by a majority vote, and the hearing shall proceed ex parte. If the subcommittee is unable to resolve the grievance, the grievance may be referred in accordance with Step 4 of Article 11.

## **ARTICLE 11**

### **GRIEVANCE PROCEDURE**

- 11.1 All disputes concerning the interpretation and/or application of this Agreement which do not fall within the Article 5, No Strikes - No Lockouts procedure or Article 6, Work Assignments and Jurisdictional Disputes shall be governed by the following grievance and arbitration procedure.

Employee Grievances: All disputes involving discipline and/or discharge of employees working on the Project shall be resolved through the grievance and arbitration provision contained in the MLA for the craft of the affected employee. No employee working on the Project shall be disciplined or dismissed without just cause.

- 11.2 Grievances between the parties regarding interpretation and/or application of this Agreement shall be pursued according to the following provisions:

11.2.1 A grievance shall be considered null and void if not brought to the attention of the party against whom the grievance is filed within ten (10) working days after the grievance is alleged to have occurred but in no event more than thirty (30) days after the charging party became aware of the event giving rise to the dispute.

11.2.2 Grievances between the parties regarding provisions of this Agreement shall be settled or otherwise resolved according to the following Steps and provisions:

Step 1: A representative of the grievant and the party against whom the grievance is filed shall meet and attempt to resolve the grievance.

Step 2: In the event the matter remains unresolved in Step 1 above, within five (5) working days, the grievance shall be reduced to writing and may then be referred by the grieving party to the other party for discussion and resolution.

Step 3: In the event that the representatives are unable to resolve the dispute within the five (5) working days after its referral to Step 2, either involved party may submit the dispute within five (5) working days to the Joint Administrative Subcommittee established in Section 10.2. The Joint Administrative Subcommittee shall meet within five (5)

working days after such referral (or such longer time as is mutually agreed upon by the representatives on the Joint Administrative Subcommittee) to confer in an attempt to resolve the grievance. If a Union(s) is party to the grievance, regardless of which party has initiated the grievance proceeding, prior to the meeting of the Joint Administrative Subcommittee, the Union(s) shall notify its International Union Representative(s), which shall advise both parties if it intends on participating in the meeting. The participation by the International Union Representative in this Step 3 meeting shall not delay the time set herein for the meeting, unless otherwise mutually agreed by the parties. If the dispute is not resolved by the Joint Administrative Subcommittee, it may be referred within five (5) working days by either party to Step 4.

At the time a grievance is submitted under this Agreement or any MLA, the Union(s) may request that the District withhold and retain an amount from what is due and owing to the Contractor/Employer(s) against whom the grievance is filed, sufficient to cover the damages alleged in the grievance, should the Union(s) prevail.

The amount shall be retained by the District until such time as the underlying grievance giving rise to the retention is withdrawn, settled, or otherwise resolved, and the retained amount shall be paid to whomever the parties to the grievance shall decide, or to whomever an Arbitrator shall so order.

Step 4: In the event the matter remains unresolved in Step 3, either Party may request, within five (5) working days, that the dispute be submitted to arbitration. The time limits set out in this procedure may, upon mutual agreement, be extended. Any request for arbitration, request for extension of time limits, and agreement to extend such time limits shall be in writing.

Step 5: The Parties agree that the Arbitrator who will hear the grievance shall be selected from the following: William Riker, Robert Hirsch, and Barry Winograd. The parties shall flip a coin to determine who shall strike the first name and shall then alternately strike names from the list and the last remaining name shall be the neutral third party Arbitrator who shall resolve the dispute in a final and binding manner. Should a Party to the procedure fail or refuse to participate in the hearing, if the Arbitrator determines that proper notice of the hearing has been given, said hearing shall proceed to a default award. The Arbitrator's award shall be final and binding on all Parties to the arbitration. The costs of the arbitration, including the Arbitrator's fee and expenses, shall be borne equally by the Parties. The Arbitrator's decision shall be confined to the question(s) posed by the grievance and the Arbitrator shall not have authority to modify amend, alter, add to, or subtract from, any provisions of this Agreement.

- 11.3 Grievances between a Union(s) and a Union(s)' signatory Contractor/Employer(s) involving interpretation or application of the MLA shall be governed by the grievance procedures contained in the MLA.

## **ARTICLE 12**

### **UNION RECOGNITION AND REPRESENTATION**

- 12.1 The Contractor/Employer(s) recognize the Union(s) signatory hereto as the sole and exclusive collective bargaining representatives for all craft employees on the Project.
- 12.2 The Contractor/Employer(s) shall require all employees who work on a Construction Contract on or before eight days of consecutive or cumulative employment on the Project to comply with the applicable Union(s)' security provisions, and to maintain compliance for the period of time they are performing work on the Project, which requirement shall be satisfied by the tendering of periodic dues and fees uniformly required to the extent allowed by law. Further, there is nothing in this Agreement that would prevent non-union employees from joining the Union(s).
- 12.3 Authorized representatives of the Union(s) shall have access to the site at all times. Such representatives shall comply with reasonable visitor safety and security rules established for the Project.

## **ARTICLE 13**

### **REFERRAL PROCESS**

13. The Union(s) shall be the primary source of all craft labor employed on the Project. However, in the event that an Oakland Certified Local Business Contractor has its own core workforce, or a non-Local Contractor/Employer has Oakland Residents on its own core workforce, (collectively "Core Employees") the following provisions shall apply, consistent with the MLA hiring hall provisions:

A. Contractor/Employers with Oakland Resident employees may request by name, and the Union(s) shall honor, referral of persons who have applied to the local union for Project work and who demonstrate the following qualifications:

- 13.1.1 possess any license and/or certifications required by state or federal law for the Project work to be performed;
- 13.1.2 have worked a total of at least one thousand five hundred (1500) hours in the construction craft during the prior three (3) years;
- 13.1.4 were on the Contractors' active payroll for at least sixty (60) out of one hundred forty (140) days the Contractor was actively performing work prior to the contract award;

13.1.5 have the ability to perform safely the basic functions of the applicable trade;  
and

13.1.6 be an Oakland Resident at least six months prior to the award of the contract  
for which they are being dispatched.

B. Oakland Certified Small Local Contractors may request by name, and the Union(s) shall honor, referral of persons who have applied to the local union for Project work and who demonstrate the following qualifications:

13.1.6 possess any license and/or certifications required by state or federal law for  
the Project work to be performed;

13.1.7 have worked a total of at least five hundred (500) hours in the construction  
craft during the prior three (3) years;

13.1.8 were on the Contractors' active payroll for at least forty-five (45) out of the  
one hundred forty (140) calendar days prior to the contract award.; and

13.1.9 have the ability to perform safely the basic functions of the applicable trade.

13.2 A Sole Operator, as defined in this Agreement under section 1.10, self-performing work on a covered Project shall not be required to request dispatch from the union hall with jurisdiction over the Sole Operator's work. However, if the Sole Operator hires any additional employees subsequent to starting work on a covered Project, the Sole Operator will be treated as the core employee and any subsequent employee(s) will be dispatched from the hiring hall. Before hiring an employee(s) on the Project, the Sole Operator must request permission from the JAC through the Coordinator and provide evidence of compliance with CLSB and Workers Compensation requirements. For purposes of this Agreement, Trucking Sole Operators will be treated as the core employee, but must nevertheless be dispatched from the hiring hall, will be exempt from trust fund obligations but must pay representational fees. All Sole Operators, including truckers, must sign this Agreement's Letter of Assent prior to starting work on a covered Project

13.3 The Union will first refer to such Local or Non-local Contractor/Employer(s) one employee from the hiring hall out-of-work list for each affected craft and will then refer one of the Core Employees who meet the listed qualifications. This referral process shall be repeated until such Contractor/Employer's crew requirements are met or until such Contractor has hired five (5) Core workers, whichever occurs first. Thereafter, all additional employees in the affected trade or craft shall be hired exclusively from the hiring hall out-of-work list(s). Employees shall be laid off in the same one-for-one manner in the inverse order of their hiring. For the duration of the Contractors' work the ratio shall be maintained and when the Contractors' workforce is reduced, Employees shall be laid off in the same ratio of core employees to hiring hall referrals as was applied in the initial hiring. Contractors signatory to a Local, Regional, and/or National collective bargaining agreement(s) with Signatory Union(s) hereto shall be bound to use the hiring hall provisions contained in the relevant MLA of the affected Union(s), and nothing in the referral provisions of this Agreement shall be construed to supersede the local hiring hall provisions of the MLAs as they relate to such Contractors.

- 13.4 All Contractors shall be bound by and utilize the registration facilities and referral systems established or authorized by the Signatory Union(s) so long as such procedures are in compliance with applicable federal, state or local law. The Contractor shall have the right to determine the competency of all employees and may reject any referral for any reason, provided that the Contractor complies with Article 22, Non-Discrimination, and in accordance with the applicable MLA.
- 13.5 In accordance with the Master Labor Agreement and in the event that referral facilities maintained by the Union(s) are unable, despite good faith efforts, to fill the request of a Contractor for employees within a forty-eight (48) hour period after such request is made by the Contractor, Saturdays, Sundays and Holidays excluded, the Contractor shall be free to obtain work persons from any source ("Alternative Employees"). Upon hiring Alternative Employees, the Contractor shall immediately notify the appropriate Union(s) of the name and address of the Alternative Employees hired, which Alternative Employees shall be bound by the provisions of this Article and the Union(s)' hiring hall rules.
- 13.6** The Union(s) will exert their utmost efforts to recruit sufficient numbers of skilled craft persons to fulfill the requirements of the Contractors. The parties to this Agreement support the development of increased numbers of skilled construction workers from the Residents of Oakland / District to meet the needs of the Project and the requirements of the industry generally. Accordingly, contingent upon request by the Contractor, the Unions agree to encourage the referral and utilization of Residents as journeyman and apprentices on the Project and the entrance of Residents into apprenticeships and training programs, as long as such Residents possess the requisite skills and qualifications.

## **ARTICLE 14**

### **LOCAL HIRING**

- 14.1 The Parties agree to achieve the inclusion of OUSD graduates and Oakland Residents in the employment and apprenticeship opportunities created by the Covered Work, which will be known as the Local Hiring Program (LHP). With day-to-day support from the District, the Joint Administrative Committee (JAC) formed pursuant to the provisions of Article 8 shall monitor the progress of the LHP and will serve as the central forum for representatives of all affected parties to exchange information and ideas and to advise the District staff and consultants concerning the implementation and enforcement of the LHP.
- 14.2 The parties agree to a goal that for each construction contract, Residents of the District will perform up to 50 percent (50%) of all hours worked on all covered projects, on a craft-by-craft basis, if such workers are available, capable and willing to work on the projects, together with the apprentice goals established in Article 15, below.
- 14.3 The Contractors shall make good faith efforts to reach these goals, as described in Article 14.4 below and to reach these goals in accordance with the hiring hall procedures listed in the MLAs and the procedures identified in Article 15.4. The

District and the Unions shall make good faith efforts to assist the Contractor in reaching this goal. In cases of alleged noncompliance, the issue may be initially referred to the JAC for resolution. If the JAC can make no resolution, the issue may then be referred to the grievance procedure described in Article 11 for a final and binding determination. For purposes of resolution of any dispute arising under this Section or Article, the District shall be considered a party-in-interest with full right of participation in the arbitration proceeding.

14.4 In accordance to the MLA dispatch procedures, the Contractors must take, and require their subcontractors to take, the following good faith steps to demonstrate that they have made every effort to reach the Local Hiring Goals:

14.4.1 The Contractors shall attend the scheduled pre-job meetings identified in Article 7. At this meeting, the Contractor must submit written workforce projections and projected man-hours on a craft-by-craft basis, consistent with the Contractor's bid proposal. In the event the pre-job meeting is waived, the Contractor must submit written workforce projections to the Coordinator within five (5) days.

14.4.2 Within one week of the issuance of the Notice to Proceed, the Contractors shall meet with the District to review and approve the Contractor's compliance plan for reaching the Local Hiring and apprentice Goals, using the required compliance plan form provided by the District.

14.4.3 The Contractors shall submit copies of hiring hall dispatch requests and responses to the Coordinator within ten (10) days of Coordinator's request at any point during the execution of the Project.

14.4.4 The Contractors shall immediately contact the District if a union hiring hall dispatcher, upon request of the Contractor, is unable to dispatch local Residents.

14.4.5 The Contractors shall use the "Name Call," "Rehire" or other available hiring hall procedures to reach goals and shall provide documentation of such requests to the Coordinator upon request per subsection.

14.4.6 The Contractors shall use community based organizations from the list approved by the District and the Council as a resource for local labor resources, if a union cannot provide local Residents as requested.

14.4.7 The Contractors shall sponsor local Residents as defined herein for apprenticeship, when possible.

14.4.8 The Contractors shall maintain records for each Resident of Oakland/District who was referred but not hired along with an explanation why the worker was not hired. Upon request, such records shall be made available for review by the District, Coordinator, and JAC for the duration of the Covered Projects.

14.4.9 The Contractors shall document participation in any local employment training programs and submit documentation of such to the Coordinator within ten (10) days if requested by Coordinator.

- 14.4.10 In the event that Local Unions are unable to fill any request for local employees within forty-eight (48) hours after such request is made by the Contractor (Saturdays, Sundays, and holidays excepted), the Contractor may employ local residents from any other available source, including District apprentice program graduates and community-based pre-apprentice organizations located within the District. However they must be dispatched through the union halls through the dispatch procedures outlined in the MLAs.
- 14.5 To the extent possible, the parties agree to implement the Local Hiring Program while complying with the District's Local Business programs for the covered project. To the extent that the District determines, in its sole discretion, that there is a conflict between the Local Hiring Program established in this Agreement and the District's Local Business Program, the conflict shall be resolved in favor of the Local Hiring Program on the construction work covered by this Agreement.
- 14.6 For the purposes of reaching the goal established in this Article, a Contractor may qualify for full credit toward the goal by employing OUSD Graduates and Oakland Residents for other work the Contractor is performing in any of the nine Bay Area counties of: Alameda, Contra Costa, San Francisco, San Mateo, Santa Clara, Marin, Solano, Napa and Sonoma. Credit will only be given for work performed during the life of the Covered Project. In order to receive such credit, the Contractor must submit certified payrolls as documentation to the Coordinator. No credit for off-site work will be allowed until the Contractor has received approval from the District.

## **ARTICLE 15**

### **APPRENTICES**

- 15.1. The District and Unions recognize the need to maintain continuing support of programs designed to develop adequate numbers of competent workers in the construction industry. The District and the Unions agree to provide financial and other assistance to enhance and sustain such programs through appropriate sources. The Contractor(s) will employ apprentices in the respective crafts, which are performing work on the Covered Project, and within the jurisdiction of the craft in which those apprentices are working.
- 15.2. Subject to any restrictions contained in law, the Parties agree to a goal that apprentices will perform up to twenty percent (20%) of the total craft work hours. The Unions agrees to cooperate with the Contractor in furnishing apprentices as requested and in accordance to the dispatch procedures of the MLAs.
- 15.3. The parties agree to a goal that only Oakland residents, especially District graduates shall be utilized as apprentices. The Contractor shall make good faith efforts to reach this goal through the utilization of MLA hiring hall and apprentice procedures and, when apprentices are not available; Contractors shall work with community-based organizations such as, but not limited to, the Cypress Mandela Training Center and the West Oakland Jobs Resource Center to identify potential apprentices.

- a. For the purposes of meeting the goals established in Section 15.2 and 15.3, a Contractor may qualify for up to one-half (1/2) of the goal by employing Oakland resident apprentices, especially District graduates on non-Covered work the Contractor is performing at the same time it is working on Covered Project. In order to receive such credit, the Contractor must submit request for off-site credit along with supportive documentation such as but not limited to certified payroll reports to the Coordinator. No credit for other work will be allowed until the Contractor has received written approval from the Coordinator.
  - b. For the purposes of meeting the goal established in Section 15.2, District apprentices hired to perform Covered Project who have graduated and become journeypersons may continue to be counted towards the goal for the duration of the Covered Project or until such time as they are laid-off in the normal course of worker reductions at the end of the contractor's scope of work, whichever is sooner. In order to receive such credit, the Contractor must submit request for graduated apprentice credit along with supportive documentation such as but not limited to certified payroll reports to the Coordinator.
- 15.4. For each Covered Project, a Contractor and/or its subcontractors must hire at least one (1) Qualifying Apprentice (as described in 15.6a) for the first one million dollars (\$1 million) of construction bid value. For each additional five million dollars (\$5 million) of construction bid value (beyond the first \$1 million), a Contractor and/or its subcontractors must hire at least one (1) additional Qualifying Apprentice.
- a. A Contractor shall make a good faith effort to maximize the Covered Project hours for the Qualifying Apprentices and shall report those hours to the JAC through the Coordinator, which will evaluate those good faith efforts. A Contractor cannot hire more than one (1) Qualifying Apprentices exclusively for a single trade to satisfy the hiring goals in this section unless approved by the JAC.
  - b. A Contractor shall make all requests for apprentices in writing. The Contractor shall report the number of Qualifying Apprentices, date of hire and hours worked to the Coordinator as well as any information about the Contractor's hiring efforts. The Coordinator will evaluate such information to determine whether the Contractor has acted in good faith to comply with this section.
  - c. In accordance with the dispatch procedures of the MLAs, each Signatory Union will be responsible for dispatching/referring District residents as Qualifying Apprentices to a Contractor on a priority basis if they are available, capable and willing to work on Covered Project. If apprentice(s) are not available, a Contractor shall be free to obtain Qualifying Apprentices from the District.
  - d. The Coordinator will track all Contractor requests for District Qualifying Apprentices and the Union responses to such requests. Copies of the written



requests shall be provided to the Coordinator within ten (10) days of request by the Coordinator.

- 15.5. The parties to this agreement shall exercise, to the extent of their authority, their best efforts to recruit District graduates as apprenticeship program applicants. In coordination with the District, the Unions will conduct outreach activities to recruit and refer qualified District graduates to apprenticeship programs. In addition, The Unions agree, for the life of this Agreement, to the annual enrollment of no less than twenty-five (25) District graduates, at least ten (10) of whom will enter the List Trades. The responsibility of the District, working with the Unions and applicable community based organizations, is to maintain, provide and track a list of such graduates. These District graduates will become part of a pool of Qualifying Apprentices for the Contractor/Employers to draw from for hiring on Covered Project. The requirements of this Section are in addition to any other goals and requirements discussed in this Article.
- 15.6. For purposes of monitoring and compliance with respect to the enrolment requirements of Section 15.5, the District and the Unions agree to the following process:
  - a. The District shall maintain and make available to the Unions a database of OUSD students enrolled in District sponsored construction related academies and District graduates of those academies. The District graduates must have graduated from MC3 approved pre-apprenticeship programs. Those would include, but may not be limited to, Cypress Mandela and Rising Sun,. These District students/graduates shall be referred to as "Qualifying Apprentices" for the purposes of assuring there is an adequate pool of Qualifying Apprentices for the Contractor/Employers to draw from on each Covered Project.
  - b. On an annual basis, in January, the Council shall submit a Plan for implementation (Plan) for approval by the JAC. The Plan will include projections/schedules for new apprentice intakes. It may also include the Union's commitment to job fairs, financial or human support in tutoring of District residents for math exam preparation, opportunities for District residents to enroll in union pre-apprenticeship programs, support of and participation in District high school construction academies, etc.
  - c. The Council will submit a bi-annual report to JAC on the status of recruitment, placement and retention of District apprentices, including details of outreach in the District. The reports should be made in person and with a representative of the applicable JATC present for participation in questions and discussion.
  - d. If the Council is found to be in apparent non-compliance with Article 15.5, the District may request that the Council to present to the JAC as to why the goals are not being met..

- e. If the Union fails to meet the goals of the revised Plan, the Coordinator may recommend to the JAC that the Union be referred to the grievance procedure outlined in Article 11.
  - f. At any time before referral arbitration, the Union will have the opportunity to make a satisfactory settlement agreement with the District.
- 15.7. Sanctions may be imposed for failure to meet, or demonstrate "good faith" effort to meet, any of the goals in this Article. In cases of alleged noncompliance, the issue may be referred to the JAC for resolution. If a majority of the JAC can make no resolution, the issue may then be referred to the grievance procedure of Article 11 (Grievance Procedure) for submission to an arbitrator for a final and binding determination. For purposes of resolution of any dispute arising under this Section, the District and the Coordinator shall be considered a party-in-interest with full right of participation in the arbitration proceeding.

## **ARTICLE 16**

### **PRE-APPRENTICESHIP PROGRAMS**

16.1 District and Unions are fully committed to workforce development, promoting local hiring and growing a pipeline of future employees who are Oakland residents to work on District capital projects funded with Oakland voter approved bonds. In order to achieve these goals the Parties hereby establishes the Construction and Building Trades Pre-Apprenticeship Program.

The Construction and Building Trades Pre-Apprenticeship Program is:

- a. A pathway similar to the Oakland College & Career Readiness For All Fund, *aka* Measure N, in that it will create career based learning and real-world work experiences for Oakland students;
  - 1. Will offer intensive, individualized support to create conditions for all students to succeed; and
  - 2. Will ensure that students who are interested in construction and building trades have the skills and knowledge necessary for Union apprenticeship programs.

The specific goals of the Construction and Building Trades Pre-Apprenticeship Program are: to increase high school graduation rates, decrease the high school dropout rate, increase high school students' readiness to succeed in college and career and to create a local workforce to work on District capital projects.

16.2 In order to implement the Construction and Building Trades Pre-Apprenticeship Program, the District shall:

16.2.1 Establish and fund a Summer Pre-apprenticeship Internship Program and a 3-year School Year Pre-Apprenticeship Program. The goal is to create summer pre-apprenticeships for at least thirty students at workforce development in the Building Trades.

The District will actively seek to develop at least one such program that focuses on gender equity in the building trades. The District anticipates that there may be more than one program or pathway that will meet the needs of Oakland students. Annually, for the 2017-18, 2018-19 and 2019-20, the Superintendent shall allocate \$60,000 from Measure J for the Summer Pre-apprenticeship Internship program.

16.2.2 The District shall, with the support of the Alameda County Building Trades Council, co-sponsor two Building & Construction Trades Career Fairs during each school year that provide exposure to Oakland students and families. The purpose of the career fair is to inform students and their families about career opportunities in the building trades and to inform student pathway selection and summer pre-apprenticeship programs in the building trades. The first career fair shall occur in the Fall of 2016 with the intent of exposing middle school and high school students to the trades.

16.2.3 Establish a Workforce Development Fund. The District will require that all contractors working under the Project Labor Agreement ("PLA") contribute \$.20 per work-hour performed under the PLA to a Workforce and Apprenticeship Development Fund administered by the District with the advice of the Joint Administration Committee of the PLA. The District shall establish an account for receipt and distribution of the funds. The Fund shall be audited annually as a part of the annual bond audit. 20% of the Fund may be used by the District for the costs of implementation and management of the Construction and Building Trades Pre-Apprenticeship Programs. No less than 80% of the Fund shall be used to fund direct work based learning programs and apprenticeships for Oakland students.

16.2.4. In collaboration with the Council, establish an Industry Partnership Council specifically focused on the Building and Construction Trades to support the successful implementation of this program including but not limited to:

- Establishing clear commitments for developing student pre-apprenticeships.
- Setting clear targets and goals for work based learning experiences, apprenticeships, and student outcomes.
- Identification of key industry standards necessary to achieve mastery in key industry standards
- Providing feedback on developed curriculum
- Providing feedback on the developed curriculum to support implementation including practical cases relevant for occupational expertise.
- Reflect yearly on the overall goals and targets that we set the previous year and track long term trends for student entry into the workforce.

## **ARTICLE 17**

### **WAGE SCALES AND FRINGE BENEFITS**

17.1 All Contractor/Employer(s) agree to pay contributions to the established vacation, pension and other form of deferred compensation plan, apprenticeship, health benefit funds, and all other contributions established by the applicable MLA for each hour worked on the Project in the amounts designated in the MLAs of the appropriate Union(s) and paid in accordance with the MLA. The Contractor/Employer(s) shall not be required to pay contributions to any other trust funds or other contributions that are not contained in the published prevailing wage determination to satisfy their obligation under this Article, except that those Contractor/Employer(s) who are

signatory to the MLAs with the respective trades shall continue to pay all trust fund or other contributions as outlined in such MLA's.

Wages, Hours, Terms and Conditions of Employment: The wages, hours and other terms and conditions of employment on the Project shall be governed by the MLAs of the respective Union(s), copies of which shall be made available upon request to the District to the extent such MLA is not inconsistent with this Agreement.

- 17.2 Holidays: Holidays shall be established as set forth in the applicable MLA.

## **ARTICLE 18**

### **HEALTH AND SAFETY**

- 18.1 The employees covered by the terms of this Agreement shall at all times, while in the employ of the Contractor/Employer(s), be bound by the reasonable safety rules and regulations as established by the District and Contractor/Employer(s) and in accordance with OSHA/Cal-OSHA. These rules and regulations will be published and posted at conspicuous places throughout the Project.
- 18.2 In accordance with the requirements of OSHA/Cal-OSHA, it shall be the exclusive responsibility of each Contractor/Employer(s) on the Project to assure safe working conditions for its employees and compliance by them with any safety rules contained herein or established by the Contractor/Employer(s).
- 18.3 A convenient supply of cold and potable drinking water shall be provided by the Contractor/Employer(s).
- 18.4 The Contractor/Employer(s) and Union(s) agree that the work site shall be a drug free workplace. Parties agree to recognize and use the Substance Abuse Prevention Program contained in each applicable Union(s)' MLA.

## **ARTICLE 19**

### **HELMETS TO HARDHATS**

- 19.1 The parties recognize a desire to facilitate the entry into the Building and Construction Trade Union(s) of Veterans who are interested in careers in the building and construction industry. The parties agree to utilize the services of the Center for Military Recruitment, Assessment and Veteran's Employment (hereinafter "Center") and the Center's "Helmets to Hardhats" program to serve as a resource for preliminary orientation, assessment of construction aptitude, referral to apprenticeship programs or hiring halls, counseling and mentoring, support network, employment opportunities and other needs as identified by the parties.
- 19.2 The Union(s) and Contractor/Employer(s) agree to coordinate with the Center to participate in an integrated database of Veterans interested in working on this Project and of apprenticeship and employment opportunities for this Project. To the extent permitted by law, the Union(s) will give credit to such Veterans for bona fide, provable past experience.

## **ARTICLE 20**

### **MISCELLANEOUS PROVISIONS**

- 20.1 Counterparts. This Agreement may be executed in counterparts, such that original signatures may appear on separate pages, and when bound together all necessary signatures shall constitute an original. Signature pages transmitted separately to other parties to this Agreement shall be deemed equivalent to original signatures.
- 20.2 Warranty of Authority. Each of the persons signing this Agreement represents and warrants that such person has been duly authorized to sign this Agreement on behalf of the party indicated, and each of the parties by signing this Agreement warrants and represents that such party is legally authorized and entitled to enter into this Agreement.
- 20.3 Non-Discrimination. The Contractor/Employer(s) and Union(s) agree to comply with all anti-discrimination provisions of federal, state and local law, to protect employees and applicants for employment on the Project.

## **ARTICLE 21**

### **GENERAL SAVINGS CLAUSE**

- 21.1 It is not the intention of the parties to violate any laws governing the subject matter of this Agreement. If any Article or provision of this Agreement shall be declared invalid, inoperative, or unenforceable by any competent authority of the executive, legislative, judicial or administrative branch of the federal, state or local government, the parties shall suspend the operation of each such Article or provision during the period of invalidity. Such suspension shall not affect the operation of any other provision covered in this Agreement to which the law or regulation is not applicable. Further, the District and Council agree that if and when any or all provisions of this Agreement are finally held or determined to be illegal or void by a Court of competent jurisdiction, the parties will promptly enter into negotiations concerning the substance affected by such decision for the purpose of achieving conformity with the requirements of an applicable law and the intent of the parties hereto.

## **ARTICLE 22**

### **DURATION OF AGREEMENT**

This Agreement shall become effective on the day the District ratifies this Agreement and shall continue in full force and effect for a period of five years. The parties may mutually agree in writing to amend, extend or terminate this Agreement at any time.

**ACCEPTED AND AGREED** on the date indicated below:

**OAKLAND UNIFIED SCHOOL DISTRICT**

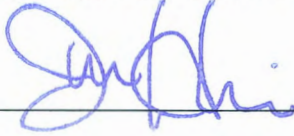

James Harris, President, Board of Education

9/29/16

Date

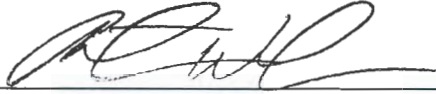

Antwan Wilson, Superintendent

9/29/16

Date

**BUILDING AND CONSTRUCTION TRADES COUNCIL  
OF ALAMEDA COUNTY, AFL-CIO**

Andreas Cluver, Secretary-Treasurer

**APPROVED AS TO FORM**

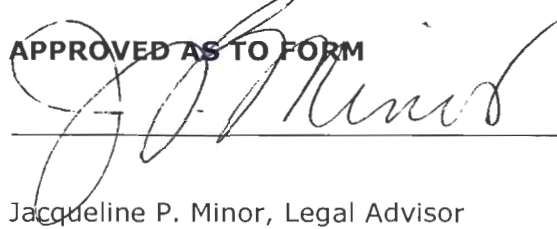

Jacqueline P. Minor, Legal Advisor

9/28/16

**SIGNATORY UNION(S)**

Asbestos Workers, Local 16

By: \_\_\_\_\_

Boilermakers, Local 549

By: \_\_\_\_\_

Bricklayers & Allied Craftsmen, Local 3

By: \_\_\_\_\_

Cement Masons, Local 300

By: \_\_\_\_\_

Electrical Workers, Local 595

By: \_\_\_\_\_

Elevator Constructors, Local 8

By: \_\_\_\_\_

Iron Workers, Local 378

By: \_\_\_\_\_

Laborers, Local 67

By: \_\_\_\_\_

Laborers, Local 304

By: \_\_\_\_\_

Operating Engineers, Local 3

By: \_\_\_\_\_

Plasterers, Local 66

By: \_\_\_\_\_

Roofers, Local 81

By: \_\_\_\_\_

Sheet Metal Workers, Local 104

By: \_\_\_\_\_

Sign Display, Local 510

By: \_\_\_\_\_

Sprinkler Fitters, Local 483

By: \_\_\_\_\_

Teamsters, Local 853

By: \_\_\_\_\_

United Association of Journeymen and  
Apprentices Fitting Industry, Underground  
Utility & Landscape, Local 355

By: \_\_\_\_\_

United Association of Steamfitters,  
Pipefitters, Plumbers, & Gas Fitters,  
Local 342

By: \_\_\_\_\_

Northern California Carpenters  
Regional Council (on behalf of Carpenters,  
Local 713, Carpenters, Local 2236, Lathers,  
Local 68L, Millwrights, Local 102,  
Pile Drivers, Local 34)

By: \_\_\_\_\_

District Council No. 16 Northern  
California International Union of  
Painters & Allied Trades (on behalf of  
Auto & Marine Painters, Local 1176,  
Carpet & Linoleum Layers, Local 12,  
Glaziers, Architectural Metal  
& Glassworkers, Local 169,  
Painters & Tapers, Local 3)

By: \_\_\_\_\_



**ADDENDUM A**  
**AGREEMENT TO BE BOUND**

The undersigned party confirms that it agrees and assents to comply with and to be bound by the Project, [NAME OF PROJECT LABOR AGREEMENT] as such Agreement may, from time to time, be amended by the parties or interpreted pursuant to its terms.

By executing this Agreement To Be Bound, the undersigned party subscribes to, adopts and agrees to be bound by the written terms of the legally established trust agreements, as set forth in Article 17.1, specifying the detailed basis upon which contributions are to be made into, and benefits made out of, such Trust Fund(s) and ratifies and accepts the trustees appointed by the parties to such Trust Fund(s). The undersigned party agrees to execute a separate Subscription Agreement(s) when such Trust Fund(s) requires such document(s).

Such assent and obligation to comply with and to be bound by this Agreement shall extend to all work covered by said Agreement undertaken by the undersigned party for the [NAME OF PROJECT]. The undersigned party shall require all of its subcontractors, of whatever tier, to become similarly bound for all their work within the scope of this Agreement by signing an identical Agreement To Be Bound.

This letter shall constitute a subscription agreement, to the extent of the terms of the letter.

Dated: \_\_\_\_\_ Project: \_\_\_\_\_

\_\_\_\_\_  
Signature of Authorized Officer

\_\_\_\_\_  
Authorized Officer & Title

\_\_\_\_\_  
Name of Contractor/Employer(s)

\_\_\_\_\_  
Contractor/Employer(s) Address

\_\_\_\_\_  
CSLB #

\_\_\_\_\_  
Area Code Phone

\_\_\_\_\_  
\_\_\_\_\_

\_\_\_\_\_  
\_\_\_\_\_

E-mail and/or Fax

Motor Carrier (CA) Permit Number

# Oakland USD

**\* ORIGINAL SIGNATURES REQUIRED**

## PLA Signature Checklist

6/1/2017

Oakland USD CONFIDENTIAL

### Required Signatory Unions

Signed

Date

Asbestos Workers, Local 16	✓	
Boilermakers, Local 549	✓	
Bricklayers & Allied Craftsmen, Local 3	✓	
Cement Masons, Local 300		
Electrical Workers, Local 595	✓	
Elevator Constructors, Local 8	✓	
<del>Laborers, Local 886</del>		
Iron Workers, Local 378	✓	
Laborers, Local 67	✓	
Laborers, Local 304	2	
Operating Engineers, Local 3	✓	
Plasterers, Local 66	✓	
Roofers, Local 81	✓	
Sheet Metal Workers, Local 104	✓	
Sign Display, Local 510	✓	
Sprinklers Fitters, Local 483	✓	
Teamsters, Local 853	✓	
U.A. Journeymen & Apprentices..., Local 355	✓	
U.A. Steamfitters, Pipefitters, Plumbers & Gas Fitters, Local 342	✓	
No. CA Carpenters Regional Council (Local 713, 2236, 68L, 102, 34)	✓	
District Council #16 Painters (Local 1176, 12, 169, 3)	✓	
District Council Iron Workers of CA & Vicinty Trades <i>*Only Regional</i>	—	—

OUSD

[Company name]

PSA Signature Checklist

[Date]

[Company name] CONFIDENTIAL

Required Signatory Unions

Signed

Asbestos Workers, Local 16		✓ 6-7-19
Boilermakers, Local 549		✓ 6-7-19
Bricklayers & Allied Craftsmen, Local 3		✓ 6-7-19
Cement Masons, Local 300	✓	8-27-19
Electrical Workers, Local 595		✓ 6-7-19
Elevator Constructors, Local 8		✓ 6-7-19
Iron Workers, Local 378		✓ 6-7-19
Laborers, Local 67		✓ 6-7-19
Laborers, Local 304	✗	8-20-19
Operating Engineers, Local 3		✓ 6-7-19
Plasterers, Local 66		✓ 6-7-19
Roofers, Local 81		✓ 6-7-19
Sheet Metal Workers, Local 104		✓ 6-7-19
Sign Display, Local 510		✓ 6-7-19
Sprinklers Fitters, Local 483		✓ 6-7-19
Teamsters, Local 853		✓ 6-7-19
U.A. Journeymen & Apprentices..., Local 355		✓ 6-7-19
U.A. Steamfitters, Pipefitters, Plumbers & Gas Fitters, Local 342	✗	8-27-19
No. CA Carpenters Regional Council (Local 713, 2236, 68L, 102, 34)	✓	12-1-19
District Council #16 Painters (Local 1176, 12, 169, 3)		✓ 6-7-19
District Council Iron Workers of CA & Vicinity Trades *Only Regional		✓ 6-7-19

**SIGNATORY UNION(S)**

Asbestos Workers, Local 16

By: 

Boilermakers, Local 549

By: \_\_\_\_\_

Bricklayers & Allied Craftsmen, Local 3

By: \_\_\_\_\_

Cement Masons, Local 300

By: \_\_\_\_\_

Electrical Workers, Local 595

By: \_\_\_\_\_

Elevator Constructors, Local 8

By: \_\_\_\_\_

Iron Workers, Local 378

By: \_\_\_\_\_

Laborers, Local 67

By: \_\_\_\_\_

Laborers, Local 304

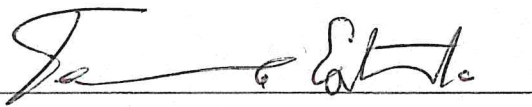
By: 

Operating Engineers, Local 3

By: \_\_\_\_\_

Plasterers, Local 66

By: \_\_\_\_\_

Roofers, Local 81

By: \_\_\_\_\_

**SIGNATORY UNION(S)**

Asbestos Workers, Local 16

By: \_\_\_\_\_

Boilermakers, Local 549

By: Mark L. Sloan

Bricklayers & Allied Craftsmen, Local 3

By: \_\_\_\_\_

Cement Masons, Local 300

By: \_\_\_\_\_

Electrical Workers, Local 595

By: \_\_\_\_\_

Elevator Constructors, Local 8

By: \_\_\_\_\_

Iron Workers, Local 378

By: \_\_\_\_\_

Laborers, Local 67

By: \_\_\_\_\_

Laborers, Local 304

By: \_\_\_\_\_

Operating Engineers, Local 3

By: \_\_\_\_\_

Plasterers, Local 66

By: \_\_\_\_\_

Roofers, Local 81

By: Donald Ziegler

**SIGNATORY UNION(S)**

Asbestos Workers, Local 16

By: \_\_\_\_\_

Boilermakers, Local 549

By: \_\_\_\_\_

Bricklayers & Allied Craftsmen, Local 3

By: *Angi Bell*

Cement Masons, Local 300

By: *Keith Jones*

Electrical Workers, Local 595

By: \_\_\_\_\_

Elevator Constructors, Local 8

By: \_\_\_\_\_

Iron Workers, Local 378

By: \_\_\_\_\_

Laborers, Local 67

By: \_\_\_\_\_

Laborers, Local 304

By: \_\_\_\_\_

Operating Engineers, Local 3

By: \_\_\_\_\_

Plasterers, Local 66

By: \_\_\_\_\_

Roofers, Local 81

By: \_\_\_\_\_

**SIGNATORY UNION(S)**

Asbestos Workers, Local 16

By: \_\_\_\_\_

Boilermakers, Local 549

By: \_\_\_\_\_

Bricklayers & Allied Craftsmen, Local 3

By: \_\_\_\_\_

Cement Masons, Local 300

By: \_\_\_\_\_

Electrical Workers, Local 595

By: *Daniel D Chivello*

Elevator Constructors, Local 8

By: \_\_\_\_\_

Iron Workers, Local 378

By: \_\_\_\_\_

Laborers, Local 67

By: \_\_\_\_\_

Laborers, Local 304

By: \_\_\_\_\_

Operating Engineers, Local 3

By: \_\_\_\_\_

Plasterers, Local 66

By: \_\_\_\_\_

Roofers, Local 81

By: \_\_\_\_\_



**SIGNATORY UNION(S)**

Asbestos Workers, Local 16 By: \_\_\_\_\_

Boilermakers, Local 549 By: \_\_\_\_\_

Bricklayers & Allied Craftsmen, Local 3 By: \_\_\_\_\_

Cement Masons, Local 300 By: \_\_\_\_\_

Electrical Workers, Local 595 By: \_\_\_\_\_

Elevator Constructors, Local 8 By: Eric W. Ph. Clark

Iron Workers, Local 378 By: \_\_\_\_\_

Laborers, Local 67 By: \_\_\_\_\_

Laborers, Local 304 By: \_\_\_\_\_

Operating Engineers, Local 3 By: \_\_\_\_\_

Plasterers, Local 66 By: \_\_\_\_\_

Roofers, Local 81 By: \_\_\_\_\_

**SIGNATORY UNION(S)**

Asbestos Workers, Local 16 By: \_\_\_\_\_

Boilermakers, Local 549 By: \_\_\_\_\_

Bricklayers & Allied Craftsmen, Local 3 By: \_\_\_\_\_

Cement Masons, Local 300 By: \_\_\_\_\_

Electrical Workers, Local 595 By: \_\_\_\_\_

Elevator Constructors, Local 8 By: \_\_\_\_\_

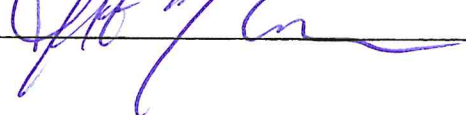
Iron Workers, Local 378 By:  \_\_\_\_\_

Laborers, Local 67 By: \_\_\_\_\_

Laborers, Local 304 By: \_\_\_\_\_

Operating Engineers, Local 3 By: \_\_\_\_\_

Plasterers, Local 66 By: \_\_\_\_\_

Roofers, Local 81 By: \_\_\_\_\_

**SIGNATORY UNION(S)**

Asbestos Workers, Local 16 By: \_\_\_\_\_

Boilermakers, Local 549 By: \_\_\_\_\_

Bricklayers & Allied Craftsmen, Local 3 By: \_\_\_\_\_

Cement Masons, Local 300 By: \_\_\_\_\_

Electrical Workers, Local 595 By: \_\_\_\_\_

Elevator Constructors, Local 8 By: \_\_\_\_\_

Iron Workers, Local 378 By: \_\_\_\_\_

Laborers, Local 67 By: \_\_\_\_\_

Laborers, Local 304 By: \_\_\_\_\_

Operating Engineers, Local 3 By: \_\_\_\_\_

Plasterers, Local 66 By: \_\_\_\_\_

Roofers, Local 81 By: \_\_\_\_\_

A handwritten signature in blue ink, consisting of several overlapping diagonal strokes, is written over the signature lines for Laborers, Local 67 and Laborers, Local 304.

**SIGNATORY UNION(S)**

Asbestos Workers, Local 16

By: \_\_\_\_\_

Boilermakers, Local 549

By: \_\_\_\_\_

Bricklayers & Allied Craftsmen, Local 3

By: \_\_\_\_\_

Cement Masons, Local 300

By: \_\_\_\_\_

Electrical Workers, Local 595

By: \_\_\_\_\_

Elevator Constructors, Local 8

By: \_\_\_\_\_

Iron Workers, Local 378

By: \_\_\_\_\_

Laborers, Local 67

By: \_\_\_\_\_

Laborers, Local 304

By: \_\_\_\_\_

Operating Engineers, Local 3

By:  \_\_\_\_\_

Plasterers, Local 66

By: \_\_\_\_\_

Roofers, Local 81

By: \_\_\_\_\_

**SIGNATORY UNION(S)**

Asbestos Workers, Local 16 By: \_\_\_\_\_

Boilermakers, Local 549 By: \_\_\_\_\_

Bricklayers & Allied Craftsmen, Local 3 By: \_\_\_\_\_

Cement Masons, Local 300 By: \_\_\_\_\_

Electrical Workers, Local 595 By: \_\_\_\_\_

Elevator Constructors, Local 8 By: \_\_\_\_\_

Iron Workers, Local 378 By: \_\_\_\_\_

Laborers, Local 67 By: \_\_\_\_\_

Laborers, Local 304 By: \_\_\_\_\_

Operating Engineers, Local 3 By: \_\_\_\_\_

Plasterers, Local 66 By: Robert J. Mato

Roofers, Local 81 By: \_\_\_\_\_

**SIGNATORY UNION(S)**

Asbestos Workers, Local 16

By: \_\_\_\_\_

Boilermakers, Local 549

By: \_\_\_\_\_

Bricklayers & Allied Craftsmen, Local 3

By: \_\_\_\_\_

Cement Masons, Local 300

By: \_\_\_\_\_

Electrical Workers, Local 595

By: \_\_\_\_\_

Elevator Constructors, Local 8

By: \_\_\_\_\_

Iron Workers, Local 378

By: \_\_\_\_\_

Laborers, Local 67

By: \_\_\_\_\_

Laborers, Local 304

By: \_\_\_\_\_

Operating Engineers, Local 3

By: \_\_\_\_\_

Plasterers, Local 66

By: \_\_\_\_\_

Roofers, Local 81

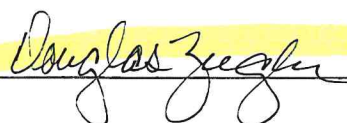
By:  \_\_\_\_\_

Sheet Metal Workers, Local 104

By:  \_\_\_\_\_

Sign Display, Local 510

By: \_\_\_\_\_

Sprinkler Fitters, Local 483

By: \_\_\_\_\_

Teamsters, Local 853

By: \_\_\_\_\_

United Association of Journeymen and  
Apprentices Fitting Industry, Underground  
Utility & Landscape, Local 355

By: \_\_\_\_\_

United Association of Steamfitters,  
Pipefitters, Plumbers, & Gas Fitters,  
Local 342

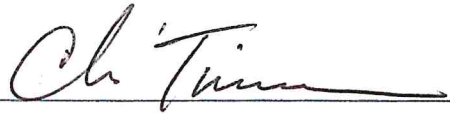
By:  \_\_\_\_\_

Northern California Carpenters  
Regional Council (on behalf of Carpenters,  
Local 713, Carpenters, Local 2236, Lathers,  
Local 68L, Millwrights, Local 102,  
Pile Drivers, Local 34)

By: \_\_\_\_\_

District Council No. 16 Northern  
California International Union of  
Painters & Allied Trades (on behalf of  
Auto & Marine Painters, Local 1176,  
Carpet & Linoleum Layers, Local 12,  
Glaziers, Architectural Metal  
& Glassworkers, Local 169,  
Painters & Tapers, Local 3)

By: \_\_\_\_\_

Sheet Metal Workers, Local 104

By: \_\_\_\_\_

Sign Display, Local 510

By: Joseph B. Toback

Sprinkler Fitters, Local 483

By: \_\_\_\_\_

Teamsters, Local 853

By: \_\_\_\_\_

United Association of Journeymen and  
Apprentices Fitting Industry, Underground  
Utility & Landscape, Local 355

By: \_\_\_\_\_

United Association of Steamfitters,  
Pipefitters, Plumbers, & Gas Fitters,  
Local 342

By: \_\_\_\_\_

Northern California Carpenters  
Regional Council (on behalf of Carpenters,  
Local 713, Carpenters, Local 2236, Lathers,  
Local 68L, Millwrights, Local 102,  
Pile Drivers, Local 34)

By: \_\_\_\_\_

District Council No. 16 Northern  
California International Union of  
Painters & Allied Trades (on behalf of  
Auto & Marine Painters, Local 1176,  
Carpet & Linoleum Layers, Local 12,  
Glaziers, Architectural Metal  
& Glassworkers, Local 169,  
Painters & Tapers, Local 3)

By: \_\_\_\_\_



Sheet Metal Workers, Local 104

By: \_\_\_\_\_

Sign Display, Local 510

By: \_\_\_\_\_

Sprinkler Fitters, Local 483

By:  \_\_\_\_\_

Teamsters, Local 853

By: \_\_\_\_\_

United Association of Journeymen and  
Apprentices Fitting Industry, Underground  
Utility & Landscape, Local 355

By: \_\_\_\_\_

United Association of Steamfitters,  
Pipefitters, Plumbers, & Gas Fitters,  
Local 342

By: \_\_\_\_\_

Northern California Carpenters  
Regional Council (on behalf of Carpenters,  
Local 713, Carpenters, Local 2236, Lathers,  
Local 68L, Millwrights, Local 102,  
Pile Drivers, Local 34)

By: \_\_\_\_\_

District Council No. 16 Northern  
California International Union of  
Painters & Allied Trades (on behalf of  
Auto & Marine Painters, Local 1176,  
Carpet & Linoleum Layers, Local 12,  
Glaziers, Architectural Metal  
& Glassworkers, Local 169,  
Painters & Tapers, Local 3)

By: \_\_\_\_\_

Sheet Metal Workers, Local 104

By: \_\_\_\_\_

Sign Display, Local 510

By: \_\_\_\_\_

Sprinkler Fitters, Local 483

By: \_\_\_\_\_

Teamsters, Local 853

By:  \_\_\_\_\_

United Association of Journeymen and  
Apprentices Fitting Industry, Underground  
Utility & Landscape, Local 355

By: \_\_\_\_\_

United Association of Steamfitters,  
Pipefitters, Plumbers, & Gas Fitters,  
Local 342

By: \_\_\_\_\_

Northern California Carpenters  
Regional Council (on behalf of Carpenters,  
Local 713, Carpenters, Local 2236, Lathers,  
Local 68L, Millwrights, Local 102,  
Pile Drivers, Local 34)

By: \_\_\_\_\_

District Council No. 16 Northern  
California International Union of  
Painters & Allied Trades (on behalf of  
Auto & Marine Painters, Local 1176,  
Carpet & Linoleum Layers, Local 12,  
Glaziers, Architectural Metal  
& Glassworkers, Local 169,  
Painters & Tapers, Local 3)

By: \_\_\_\_\_

Sheet Metal Workers, Local 104

By: \_\_\_\_\_

Sign Display, Local 510

By: \_\_\_\_\_

Sprinkler Fitters, Local 483

By: \_\_\_\_\_

Teamsters, Local 853

By: \_\_\_\_\_

United Association of Journeymen and  
Apprentices Fitting Industry, Underground  
Utility & Landscape, Local 355

By:  \_\_\_\_\_

United Association of Steamfitters,  
Pipefitters, Plumbers, & Gas Fitters,  
Local 342

By: \_\_\_\_\_

Northern California Carpenters  
Regional Council (on behalf of Carpenters,  
Local 713, Carpenters, Local 2236, Lathers,  
Local 68L, Millwrights, Local 102,  
Pile Drivers, Local 34)

By: \_\_\_\_\_

District Council No. 16 Northern  
California International Union of  
Painters & Allied Trades (on behalf of  
Auto & Marine Painters, Local 1176,  
Carpet & Linoleum Layers, Local 12,  
Glaziers, Architectural Metal  
& Glassworkers, Local 169,  
Painters & Tapers, Local 3)

By: \_\_\_\_\_

Sheet Metal Workers, Local 104

By: \_\_\_\_\_

Sign Display, Local 510

By: \_\_\_\_\_

Sprinkler Fitters, Local 483

By: \_\_\_\_\_

Teamsters, Local 853

By: \_\_\_\_\_

United Association of Journeymen and  
Apprentices Fitting Industry, Underground  
Utility & Landscape, Local 355

By: \_\_\_\_\_

United Association of Steamfitters,  
Pipefitters, Plumbers, & Gas Fitters,  
Local 342

By: \_\_\_\_\_

Northern California Carpenters  
Regional Council (on behalf of Carpenters,  
Local 713, Carpenters, Local 2236, Lathers,  
Local 68L, Millwrights, Local 102,  
Pile Drivers, Local 34)

By: \_\_\_\_\_

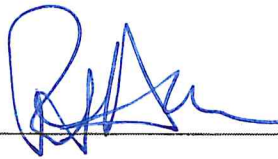

District Council No. 16 Northern  
California International Union of  
Painters & Allied Trades (on behalf of  
Auto & Marine Painters, Local 1176,  
Carpet & Linoleum Layers, Local 12,  
Glaziers, Architectural Metal  
& Glassworkers, Local 169,  
Painters & Tapers, Local 3)

By: \_\_\_\_\_

Sheet Metal Workers, Local 104 By: \_\_\_\_\_

Sign Display, Local 510 By: \_\_\_\_\_

Sprinkler Fitters, Local 483 By: \_\_\_\_\_

Teamsters, Local 853 By: \_\_\_\_\_

United Association of Journeymen and  
Apprentices Fitting Industry, Underground  
Utility & Landscape, Local 355 By: \_\_\_\_\_

United Association of Steamfitters,  
Pipefitters, Plumbers, & Gas Fitters,  
Local 342 By: \_\_\_\_\_

Northern California Carpenters  
Regional Council (on behalf of Carpenters,  
Local 713, Carpenters, Local 2236, Lathers,  
Local 68L, Millwrights, Local 102,  
Pile Drivers, Local 34) By: \_\_\_\_\_

District Council No. 16 Northern  
California International Union of  
Painters & Allied Trades (on behalf of  
Auto & Marine Painters, Local 1176,  
Carpet & Linoleum Layers, Local 12,  
Glaziers, Architectural Metal  
& Glassworkers, Local 169,  
Painters & Tapers, Local 3) By: Chitt / Chitt 1





## DIVISION OF FACILITIES PLANNING & MANAGEMENT ROUTING FORM

### Project Information

<b>Project Name</b>	Battery Storage Oakland High School Project	<b>Site</b>	304
---------------------	---	-------------	-----

### Basic Directions

**Services cannot be provided until the contract is awarded by the Board or is entered by the Superintendent pursuant to authority delegated by the Board.**

<b>Attachment Checklist</b>	<input checked="" type="checkbox"/> Proof of general liability insurance, including certificates and endorsements, if contract is over \$15,000 <input checked="" type="checkbox"/> Workers compensation insurance certification, unless vendor is a sole provider
-----------------------------	---

### Contractor Information

<b>Contractor Name</b>	Sun Power	<b>Agency's Contact</b>	Christopher Giaras				
<b>OUSD Vendor ID #</b>	004136	<b>Title</b>	Owner				
<b>Street Address</b>	1414 Harbour Way	<b>City</b>	Richmond	<b>State</b>	CA	<b>Zip</b>	94804
<b>Telephone</b>	510-620-4490	<b>Policy Expires</b>					
<b>Contractor History</b>	Previously been an OUSD contractor? <input checked="" type="checkbox"/> Yes <input type="checkbox"/> No		Worked as an OUSD employee? <input type="checkbox"/> Yes <input checked="" type="checkbox"/> No				
<b>OUSD Project #</b>	21117						

### Term of Original/Amended Contract

<b>Date Work Will Begin (i.e., effective date of contract)</b>	12-16-2021	<b>Date Work Will End By (not more than 5 years from start date; for construction contracts, enter planned completion date)</b>	6-30-2023
		<b>New Date of Contract End (If Any)</b>	

### Compensation/Revised Compensation

<b>If New Contract, Total Contract Price (Lump Sum)</b>	\$1,438,735.00	<b>If New Contract, Total Contract Price (Not To Exceed)</b>	\$
<b>Pay Rate Per Hour (If Hourly)</b>	\$	<b>If Amendment, Change in Price</b>	\$
<b>Other Expenses</b>		<b>Requisition Number</b>	

### Budget Information

*If you are planning to multi-fund a contract using LEP funds, please contact the State and Federal Office before completing requisition.*

Resource #	Funding Source	Org Key	Object Code	Amount
9650/9864	Fund 21 Msr J	210-9650-0-9863-8200-5826-304-9180-9905-9999-21117	5862	\$1,438,735.00

### Approval and Routing (in order of approval steps)

Services cannot be provided before the contract is fully approved and a Purchase Order is issued. Signing this document affirms that to your knowledge services were not provided before a PO was issued.

	<b>Division Head</b>	<b>Phone</b>	510-535-7038	<b>Fax</b>	510-535-7082
1.	<b>Executive Director, Facilities Planning &amp; Management</b>	<b>Signature</b>	Kenatman		
		<b>Date Approved</b>	11.16.2021		
2.	<b>General Counsel, Department of Facilities Planning and Management</b>	<b>Signature</b>	[Signature]		
		<b>Date Approved</b>	11/17/21		
3.	<b>Deputy Chief, Facilities Planning &amp; Management</b>	<b>Signature</b>	Kenatman for T. Nakadegawa		
		<b>Date Approved</b>	11/18/21		
4.	<b>Chief Financial Officer</b>	<b>Signature</b>			
		<b>Date Approved</b>			
5.	<b>President, Board of Education</b>	<b>Signature</b>			
		<b>Date Approved</b>			